

Psychological Operations

DISTRIBUTION RESTRICTION:

Distribution authorized to U.S. Government agencies only to protect technical or operational information from automatic dissemination under the International Exchange Program or by other means. This determination was made on 11 January 1990. Other requests for this document will be referred to Commander, U.S. Army John F. Kennedy Special Warfare Center and School, ATTN: AOJK-DT-DM, Fort Bragg, NC 28307-5000.

DESTRUCTION NOTICE:

Destroy by any method that will prevent disclosure of contents or reconstruction of the document.

*This publication supersedes FM 33-1, 31 July 1987.

U.S. Marine Corps PCN 13900023600

Table of Contents

List of Illustrations	iv	Preface	vi
-----------------------------	----	---------------	----

CHAPTER 1 - OVERVIEW

Capabilities and Limitations	1-1	Legal Aspects of PSYOP	1-5
Role and Responsibilities	1-2	PSYOP and the Operational Continuum ..	1-7
Other Uses of PSYOP Assets	1-2	Blueprint of the Battlefield	1-9
Considerations in Using PSYOP Assets ..	1-2	The Principles of War	1-9
Strategic Environment	1-4	PSYOP Programs	1-12

CHAPTER 2 - THREATS AND NATIONAL SECURITY

Types of Threats	2-1	Technological Environment	2-2
Conflict Environment	2-2	Social and Political Environment	2-3

CHAPTER 3 - PSYOP MISSIONS

Mission	3-1	PSYOP Support of Conventional Operations	3-20
Operations	3-2	PSYOP Support of Low Intensity Conflict	3-24
PSYOP Support of SOF Operations	3-10		

CHAPTER 4 - FORCE STRUCTURE

Mission	4-1	PSYOP Dissemination Battalion	4-5
Group Headquarters and Headquarters Company	4-1	PSYOP Dissemination Battalion Headquarters	4-5

Print Company	4-5	Regional Support Group	4-13
Broadcast Company	4-7	PSYOP Dissemination Company (RC) ..	4-13
Signal Company	4-8	Research and Analysis Company (RC) ..	4-17
PSYOP Regional Support Battalion and Headquarters and Support Company (AC and RC)	4-8	Tactical Support Group (RC)	4-18
Regional Support Company	4-11	PSYOP Battalion (Enemy Prisoner of War/Civilian Internee) (RC)	4-20
Tactical Support Battalion	4-11	Battalion Headquarters and Service Company (RC)	4-21
Battalion Headquarters and Support Company	4-12	PSYOP Enemy Prisoner of War/Civilian Internee Support Company	4-22
Tactical Support Company	4-12		

CHAPTER 5 - COMMAND AND CONTROL

Overview of PSYOP C ² Considerations	5-1	United States Army Civil Affairs and Psychological Operations Command (USACAPOC)	5-13
Organization for National Security	5-2	Theater Army	5-13
Joint Chiefs of Staff	5-2	Theater PSYOP	5-15
Combatant Command Organization	5-4	Deployment	5-17
Theater Organization	5-9	Levels of Mobilization	5-18
United States Special Operations Command	5-9	Communications	5-18
United States Army Special Operations Command (USASOC)	5-11	Liaison	5-20

CHAPTER 6 - EMPLOYMENT OF PSYOP FORCES

PSYOP Task Group	6-1	Tactical Support Battalion and Tactical Support Company	6-2
PSYOP Dissemination Battalion	6-1	193d Special Operations Group	6-3
EPW PSYOP Company	6-2	PSYOP Task Force	6-3
Regional Support Battalion and Regional Support Company	6-2		

CHAPTER 7 - MISSION PLANNING AND TARGETING

Mission	7-1	SOC Campaign Planning	7-5
Joint Strategic Planning Process	7-2	Joint Operations Planning and Execution Process	7-6
Theater Strategy	7-2	Joint SO Targeting Process	7-9
Campaign Planning	7-2		

Assignment of Missions and Operational Areas	7-11	Deliberate Mission Planning	7-12
Support and Sustainment Planning Process	7-11	Time-Sensitive Planning	7-13
		Planning Considerations	7-14
		Post-Mission Activities	7-16

CHAPTER 8 - INTELLIGENCE FOR PSYOP

Intelligence and Electronic Warfare	8-1	IEW Support to PSYOP	8-3
IEW Support Architecture for PSYOP	8-2	PSYOP Analysis Process	8-4

CHAPTER 9 - COMBAT SERVICE SUPPORT

Theater Army	9-1	CSS in an Immature Theater	9-8
CSS and PSYOP	9-2	Reconstitution	9-10
Sources of Supply	9-3	Resupply of PSYOP Units	9-11
CSS in a Mature Theater	9-4		

APPENDIXES

Appendix A PSYOP Capabilities, Assets, and Target Audiences in Military Operations	A-1	Appendix E PSYOP Staff Officer Duties	E-1
Appendix B PSYOP in the Operational Continuum ...	B-1	Appendix F PSYOP in Support of Enemy Prisoner of War and Civilian Internee Operations	F-1
Appendix C PSYOP Approval Process	C-1	Appendix G The Joint Chiefs of Staff, Other Military Services, and PSYOP	G-1
Appendix D Operating Systems	D-1		

GLOSSARY

Section I. Acronyms and Abbreviations	Glossary-1
Section II. Definitions	Glossary-7

REFERENCES

.....	References-1
-------	--------------

INDEX

.....	Index-1
-------	---------

LIST OF ILLUSTRATIONS

Chapter 1		HHC, PSYOP tactical support group (RC)	4-19
Force application in the operational continuum	1-7	Enemy prisoner of war/civilian internee (EPW/CI) battalion (RC)	4-20
National response	1-9	PSYOP support company (EPW/CI) (RC)	4-21
Battlefield operating systems	1-10		
Chapter 3		Chapter 5	
Differences in focus	3-11	JCS organization	5-3
Imperatives for all operational environments	3-12	Partial (PSYOP-specific) joint staff template	5-4
Operational continuum	3-21	Combatant command organization	5-5
Chapter 4		Degrees of support	5-7
PSYOP group (AC)	4-2	USSOCOM organization	5-10
HHC, PSYOP group (AC)	4-3	USASOC organization	5-12
PSYOP dissemination battalion (AC and RC)	4-5	Type theater Army organization	5-14
HSC, PSYOP dissemination battalion (AC)	4-6	A typical JPOTG	5-16
Print company, PSYOP dissemination battalion (AC)	4-6	A typical JPOTF	5-17
Broadcast company, PSYOP dissemination battalion (AC)	4-7	Deployment order matrix	5-19
Signal company, PSYOP dissemination battalion (AC)	4-9		
PSYOP regional support battalion (AC and RC)	4-10	Chapter 7	
HSC, PSYOP regional and tactical support battalions (AC)	4-10	Joint Strategic Planning System	7-3
PSYOP regional support company (AC and RC)	4-11	Campaign plan tenets	7-4
PSYOP tactical support battalion (AC and RC)	4-12	The deliberate planning process	7-6
PSYOP tactical support company (AC) ..	4-14	The time-sensitive planning process	7-7
PSYOP tactical support company (RC) ..	4-14	Joint planning summary	7-8
PSYOP regional support group (RC)	4-15	Joint SO targeting process	7-10
HHC, PSYOP regional support group (RC)	4-15	ARSOF support and sustainment process	7-11
PSYOP dissemination company (RC)	4-16	The PSYOP cycle	7-15
PSYOP research and analysis company (RC)	4-18		
PSYOP tactical support group (RC)	4-19	Chapter 8	
		The PSYOP analysis process	
		8-5	
		Chapter 9	
		ARSOF CSS options	
		9-2	
		Comparison of support relationships	
		9-2	
		PSYOP sustainment imperatives	
		9-4	
		Classes of supplies	
		9-5	
		Appendix A	
		PSYOP capabilities, assets, and target audiences in military operations	
		A-2	

Appendix B

PSYOP in support of low intensity conflict operations and in peace B-2
 PSYOP in conflict and war B-3

Appendix C

Peacetime approval process (OP3) C-2
 Wartime PSYOP approval process with CINC in theater C-3
 Wartime PSYOP approval process without CINC in theater C-4

PSYOP approval process during conflict C-5

Appendix D

Operating systems terminology D-2
 Sample hierarchy functions D-2
 Application of operating systems D-4

Appendix E

PSYOP staff officer duties E-1

Preface

Field manual (FM) 33-1 is the U.S. Army psychological operations (PSYOP) doctrinal manual. It describes PSYOP roles, missions, capabilities, and organization. It also describes PSYOP employment, command and control, and support across the operational continuum. The manual is the basis for PSYOP force design and materiel acquisition. It supports the doctrinal requirements of the Concept Based Requirements System. This manual links to the doctrine in Joint Chiefs of Staff (JCS) Publication (Pub) 3-53: and FMs 31-20, 100-5, 100-20. The manual reflects the current PSYOP force structure. It also incorporates PSYOP lessons learned during operations Desert Shield and Desert Storm.

The manual expresses the United States (U. S.) Army's current operational concept for PSYOP. Users should refer to the manual's Glossary for the meanings or definitions of the terms, acronyms, and abbreviations used in this manual.

FM 33-1 is the doctrinal guide for commanders, planners, and users of PSYOP. It is also a guide for those who must consider the psychological effect of military operations on a target audience. For PSYOP planners who use force structure, it provides the doctrinal principles to plan and prepare PSYOP elements for commitment. It also provides the principles used to direct and maintain those elements after commitment. PSYOP personnel must use their professional knowledge, skills, and judgment in adapting the principles in this manual to their specific situations. PSYOP commanders and trainers should use this manual and Army Training and Evaluation Program (ARTEP) 33-705-MTP to plan and conduct their training.

The U.S. Army John F. Kennedy Special Warfare Center and School (USAJFKSWCS) is the proponent of this publication. We would like your comments or recommendations for improving this manual. Please make your comments on a DA Form 2028 (Recommended Changes to Publications and Blank Forms), keying your comments to specific pages and paragraphs and stating your reasons for the recommended change. Mail your comments to—

Commander
U.S. Army John F. Kennedy Special
Warfare Center and School
ATTN: AOJK-DT-DM
Fort Bragg, NC 28307-5000

Unless this publication states otherwise, masculine nouns and pronouns do not refer exclusively to men.

Chapter 1

O v e r v i e w

Psychological operations are conducted across the operational continuum. The purpose of PSYOP is to induce or reinforce attitudes and behavior favorable to U.S. national goals in selected foreign target audiences. As part of Army special operations forces (ARSOF), PSYOP units support both general purpose forces and special operations forces (SOF). Chapter 3 of this manual details this support. PSYOP are products and actions designed to channel behavior in support of the commander's intent at the tactical, operational, and strategic levels.

The first person to use the term "psychological warfare" was J. F. C. Fuller, a British analyst and historian. In 1920, he prophesied that purely psychological warfare might in time replace traditional warfare. The term "psychological operations" first appeared in a 1945 operations plan by Captain E.M. Zacharias of the U.S. Navy. The plan's purpose was to hasten Japan's surrender.

The United States has a long and successful history of PSYOP. Tens of thousands of enemy soldiers have been induced to surrender or defect by PSYOP that emphasized good treatment of prisoners and maintenance of human dignity. Although the terms "psychological operations" and "psychological warfare" are recent terms, psychological actions are as old as human conflict. This manual reflects PSYOP doctrinal lessons learned from both recent and historical psychological actions.

CAPABILITIES AND LIMITATIONS

Army PSYOP support to a commander demonstrates capabilities and limitations based on several internal and external factors. Internal factors include the state of training, the availability of equipment and personnel, and the quality of intelligence on audiences in a target area. External factors include the availability of dissemination means and agents of action. Other key considerations

are the ability to coordinate programs with country teams and enough time to plan and develop programs. PSYOP support limited and general operations, provide assets for non-PSYOP dissemination missions, and give the commander a way of informing his opponent of his expectations. Appendix A details PSYOP capabilities and limitations in support of specific operations. Appendix B

details potential uses for PSYOP in the operational continuum.

PSYOP derive their chief effectiveness from being a part of a total operation. They are not a substitute for combat power. They may, however, be employed when the use of combat forces is inappropriate such as during peacetime. When skillfully and

closely integrated with military and political actions, they act as a catalyst and can often make the difference between mission success and failure.

In this chapter, the word “opponent” applies to individuals or groups in a conflict—military, political, or otherwise—with the United States, whether or not war has been formally declared.

ROLE AND RESPONSIBILITIES

Army PSYOP units usually operate as support units, not as stand-alone forces. Their primary role is to support other military units or U.S. Government agencies in reaching U.S. national objectives. Their primary responsibilities are to—

- Assess the psychological impact of military operations.

- Advise the military commander or the Department of Defense (DOD) mission director on psychological action programs.
- Develop and conduct PSYOP programs supporting military operations.
- Counter hostile propaganda.

OTHER USES OF PSYOP ASSETS

PSYOP units may support other military units in a variety of ways.

PSYOP assets may support a commander’s information and awareness program or other mission-oriented activities, such as disaster relief. In such cases, the commander must clearly distinguish that PSYOP assets are being used in a dissemination role only, not to project a PSYOP message.

PSYOP assets may support a commander’s deception plan or the covert activities of the military or other government agencies.

PSYOP assets can provide target audience intelligence and regional and language expertise. PSYOP assets can also disseminate command information and products that explain the intent of military operations to target audiences. A commander may use PSYOP assets to let his opponents or enemies know that it is honorable, as well as sensible, for individual soldiers or entire units to cease hostilities in the face of overwhelming odds and be treated humanely. A commander may also use PSYOP assets to inform civilians it is in their interest to stay in their homes or off main supply routes.

CONSIDERATIONS IN USING PSYOP ASSETS-

When commanders consider using PSYOP in military operations, they must keep in mind

the various capabilities and limitations of PSYOP and their potential impact.

PSYOP Capabilities

Some PSYOP capabilities include—

- Amplifying the effects of military operations.
- Informing audiences in denied areas.
- Overcoming censorship, illiteracy, or interrupted communications systems.
- Giving guidance or reassurance to isolated or disorganized audiences.
- Targeting opponent audiences to diminish morale or to reduce the will to resist.
- Sustaining the morale of resistance fighters.
- Exploiting ethnic, cultural, religious, or economic differences.
- Giving opponent audiences alternatives to continued conflict.
- Influencing local support for insurgents.
- Supporting deception operations.
- Projecting a favorable image of U.S. actions.
- Using face-to-face communications, key communicators, and mass media to engage every practical avenue to channel the target audience's behavior.

PSYOP Limitations

The next paragraphs identify limitations of PSYOP.

Time and Planning Considerations

PSYOP units need timely predeployment notification to assemble experts and relevant materials. PSYOP assets also need to be included early in the operation's planning process. To ensure effective support, operations officers and PSYOP liaison personnel must maintain a sustained, ongoing dialogue. Without this dialogue, PSYOP must take a shotgun approach to supporting the commander's mission.

Opponent Countermeasures

The opponent's ability to use all available means and media in effective countermeasures limits PSYOP effectiveness.

Incomplete Information

Intelligence agencies often do not include in their collection plans the factors that influence the target audience. The lack of accurate and complete data restricts the number of exploitable vulnerabilities.

Evaluation

Restrictions on news, public discussion, and travel limit the information available to evaluate PSYOP effectiveness.

Coordination

Failure to coordinate between military PSYOP units and civilian information agencies may give opponents opportunities for effective counterpropaganda. Failure to coordinate may also limit a PSYOP campaign's or message's effectiveness and possibly even have a negative effect.

Qualified Personnel

Effective PSYOP require imaginative personnel who know the target audience's language. These personnel must also understand its political, economic, cultural, social, and ideological conditions. Shortages of these personnel or the failure to employ them properly will significantly detract from a successful PSYOP campaign.

Laws of War

Various laws of war constrain the actions of the United States in conflict. FM 27-10 sets forth the laws of war contained in the Hague Conventions, Hague Regulations, Geneva Convention for the protection of War Victims, and other sources. U.S. military personnel must observe these prohibitions.

Accessibility of Potential Target Audiences

Target audiences may be beyond the limits of military PSYOP targeting methods due to physical or policy restrictions. In such cases, military PSYOP planners refer these targets to higher government targeting agencies.

STRATEGIC ENVIRONMENT

U.S. national interests and goals are more diverse now than ever before. The President outlines U.S. national security policy and strategy in his annual report, the National Security Strategy of the United States. The same is true of the Secretary of Defense's annual Defense Planning Guidance. Both documents outline U.S. national interests, major threats to those interests, and major U.S. national security goals, policy, and strategy. Key U.S. national interests include—

- The survival of the United States as a free and independent nation, with its basic values intact and its institutions and people secure.
- A healthy, growing U.S. economy that provides individual chance for prosperity and a resource base for U.S. national endeavors.
- A stable world without major threats to U.S. interests.
- The growth of human freedom, democratic institutions, and free market economies worldwide, linked by a fair and open trading system.
- Healthy and vigorous alliance relationships.

The military capability and diplomatic power of the former Soviet Union still pose a threat to U.S. interests worldwide. However, the United States faces many other challenges, such as—

- Regional conflicts.
- Proliferation of high technology and nuclear, biological, and chemical (NBC) weapons.
- International terrorism.
- International drug trafficking.
- Radical politico-religious movements.
- Instability in countries important to the United States and its allies.

The National Security Council (NSC) aids the President in formulating national security strategy. The purpose of a national security strategy is to attain national security goals.

U.S. national security strategy appears in classified national security decision directives (NSDDs) and other classified NSC documents. The goal of U.S. peacetime strategy is to deter aggression and intimidating actions against the United States and its allies. In conflict, the U.S. strategic goal is to protect U.S. and allied interests without directly using U.S. combat forces. The U.S. strategic goal in war is to end war rapidly (on favorable terms) at the lowest level of hostilities. National security goals include—

- Securing the interests of the United States and its allies.
- Encouraging and aiding U.S. allies and associates to defend themselves against aggression, coercion, subversion, insurgency, and terrorism.
- Ensuring U.S. access to critical resources, markets, the oceans, and aerospace.
- Defending and advancing the cause of democracy, freedom, and human rights throughout the world.
- Resolving regional disputes that affect U.S. interests.
- Building effective, friendly relationships with all nations sharing U.S. concerns.

National military strategy secures national security policy goals by projecting or applying military capabilities. The JCS formulate national military strategy for the Secretary of Defense. National military strategy appears in the Joint Strategic Capabilities Plan (JSCP) and other joint strategic planning documents. It supports the goals of national security strategy. National military strategic goals include—

- Deterring the direct and indirect expansion of communism worldwide.
- Defending North America and the Western Hemisphere.
- Promoting the collective security of Western Europe.
- Promoting regional stability in Latin America, East Asia, the Pacific, the Middle East, South Asia, and Africa.

LEGAL ASPECTS OF PSYOP

U.S. policy and strategy stress the use of PSYOP in conflicts short of war. Legal and political factors, however, may constrain the use of PSYOP in some cases. PSYOP planners and executors must ensure PSYOP follow U.S. and international law, especially when used offensively without a declaration of war. PSYOP commanders must ensure the legal and moral legitimacy of their operations. Obeying international law and treating civilians fairly reassure target audiences and ensure legitimacy of operations.

Implications for Commanders

All PSYOP personnel must understand the political and legal implications of their operations. Commanders at all levels must consult their legal advisors on the legal aspects of specific operations. Commanders must keep their legal advisors informed of all aspects of plans, policies, directives, and doctrine. Further, commanders must provide legal advice, guidance, and operational parameters to the operators who conduct the mission.

Responsible authorities must carefully consider the sensitivity of PSYOP and the legal risks for PSYOP personnel. All PSYOP must have a sound legal basis. PSYOP also have significant political implications. The success of PSYOP depends on how they are conducted and how others perceive them.

International Laws

PSYOP personnel must be aware of the international legal aspects of PSYOP.

The Hague Conventions

The conventions are a lawmaking treaty to which the United States is a party. The Hague Conventions are considered declaratory of customary international law and thus binding upon all states, whether signatories or not. The United States observes and enforces the terms of these conventions not superseded by the 1949 Geneva Conventions. The Hague Conventions contain many of the

most important provisions of customary international law governing warfare methods and means as well as weapons use.

Geneva Conventions

These conventions are a series of four international agreements on the treatment of prisoners of war, civilians, and the wounded and sick. The conventions limit certain military actions directed against classes of individuals.

Treaty Law in North Atlantic Treaty Organization (NATO)

The NATO treaty law governs—

- Allied Command Europe Directive 80-11.
- NATO Staff Officers' Guide.
- NATO Glossary of Terms.
- Member nations' PSYOP doctrines.

U.S. Policies and Law

PSYOP planners need to identify and resolve conflicts of legal constraints and operational requirements. PSYOP personnel must abide by public law and National Command Authorities (NCA) policy directives.

Public Laws

Various public laws affect the President's ability to respond when hostile forces threaten U.S. interests during situations short of war.

The 1973 War Powers Act. This resolution requires congressional approval to commit U.S. armed forces in hostile engagement for more than 60 days.

Title V, the 1880 Amendment of the National Security Act. This act gives Congress the authority to oversee intelligence and special activities. It requires the President to keep the congressional committee overseeing such activities fully informed and up to date. The President must provide notification before significant planned and expected Intelligence and special activities.

The President must provide requested information and material about intelligence and special activities to the congressional committee. The President must also report promptly any uncovered or failed intelligence or special activities.

The Arms Export Control Act of 1986. This act limits military advisory and training efforts to specific countries as well as to logistics, transportation, and management. The act restricts activities that support any foreign government's or group's policy, internal intelligence, and security services. It also restricts intelligence activities. Such activities must support security needs.

Foreign Assistance Act of 1983. This act authorizes military aid, education, and training to eligible foreign governments. However, as of 30 September 1989, this act no longer permits grant aid to finance such support (see DOD 5105.38-M, Security Assistance Management Manual).

Goldwater-Nichols DOD Reorganization Act of 1986. PSYOP forces stationed in the continental United States (CONUS) are under the combatant command (COCOM) of the United States Special Operations Command (USSOCOM), a unified command with global responsibilities. When operating outside CONUS, the theater warfighting commander in chief (CINC) has operational control (OPCON). (See Chapter 5.)

National Command Authorities

The NCA have promulgated several policy directives applicable to PSYOP activities.

Executive Order 12333, 4 December 1981. This executive order guides and directs the planning and conduct of intelligence and special activities. It limits certain intelligence and special activities performed by SOF. DOD Directive 5240.1 and Army Regulation (AR) 381-10 implement this executive order within DOD and the Army.

National Security Decision Directive 130. This document directs interagency coordination of peacetime PSYOP activities.

Military Policies

PSYOP personnel must be aware of military policies promulgated by various directives and publications.

DOD Directive 5100.77, 10 July 1979

This directive sets DOD policy for reporting and investigating U.S. and foreign violations of the law of armed conflict. All SOF employment must follow the law of armed conflict. Violations by hostile powers do not justify U.S. violations in reprisal.

DOD Directive 3321.1

This directive is a legal "measure" authorizing the overt peacetime psychological program (OP3).

DOD 1990 PSYOP Master Plan

JCS Pub O-2, Unified Action of Armed Forces

This document sets forth principles and doctrine for the joint operation of the U.S. armed forces. It also sets forth basic PSYOP doctrine and responsibilities.

JCS Pub 3-53, Joint Psychological Operations Doctrine

This document identifies PSYOP objectives and responsibilities and coordination responsibilities among government agencies.

JSCP

Annex D, Psychological Operations, provides national policy guidance and apportions PSYOP forces for planning purposes.

Personal Conduct

PSYOP personnel must consult their supporting legal advisor about civilian legal issues. PSYOP personnel must also maintain high personal and professional standards of conduct. It is imperative they maintain awareness of the legal aspects of their actions.

PSYOP AND THE OPERATIONAL CONTINUUM

PSYOP forces operate across the operational continuum. (See Figure 1-1.) PSYOP are normally joint in nature, but they may support combined service or coalition operations or interagency activities. The operational continuum is the strategic environment in which military forces operate. It divides the

environment into peacetime, conflict, and war operations. The application of PSYOP varies with the environment and the level of activity. The approval process for PSYOP across the operational continuum is discussed in Appendix C.

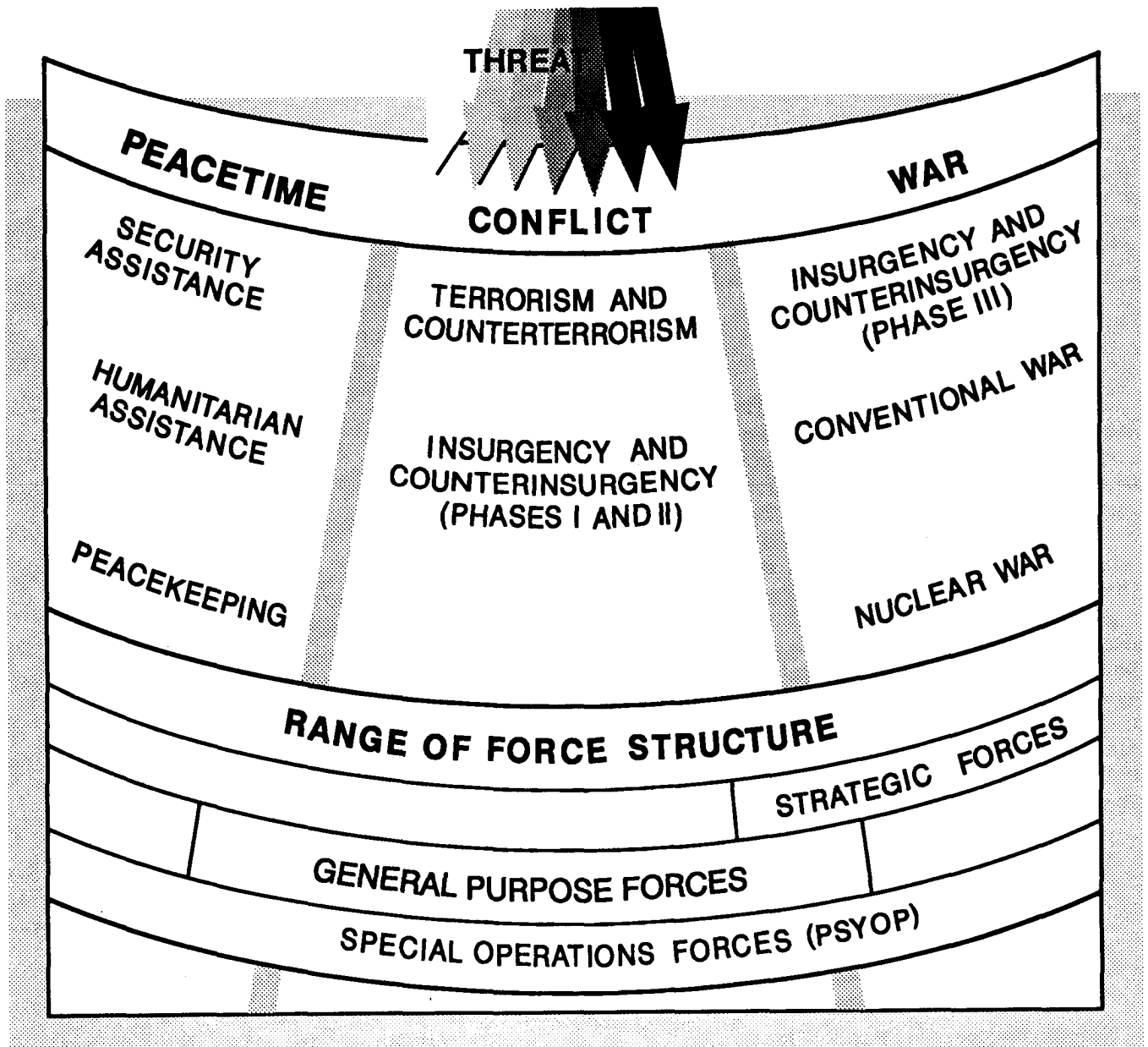

Figure 1-1. Force application in the operational continuum.

Peacetime

Peacetime is a nonhostile state during which political, economic, psychological, and military measures are used to reach national goals. The measures taken do not involve U.S. combat operations or active support to warring parties.

Strategic peacetime objectives include keeping foreign groups and countries from starting hostilities against the United States. When U.S. and allied interests are jeopardized, strategic peacetime objectives enhance potential U.S. military capabilities by projecting a favorable image of the United States and supporting U.S. public diplomacy. The OP3 that authorizes and implements peacetime PSYOP may further these goals. PSYOP in peacetime require U.S. Government interagency coordination and integration at the national and country team level.

Conflict

Conflict encompasses all spheres of national security: political, military, economic, social, and cultural. The combat power of military forces is a significant factor of conflict. Noncombat activities can be as decisive in conflict as combat operations are in conventional warfare. Failure to engage properly on the noncombat fronts can mean defeat, regardless of the outcome of military operations. Conflict is frequently a protracted politico-military struggle between political systems and ideologies. All military, economic, psychological, and social activities are effective only insofar as they support the political goal. PSYOP serve as a weapon system in this struggle by—

- Building and sustaining support for U.S. or allied political systems, including ideology, infrastructure, and political programs.
- Attacking the legitimacy and credibility of a competitor's political system.
- Mobilizing popular support for political, social, and economic programs consistent with U.S. goals.

- Publicizing planned reforms and programs that benefit the populace after a competitor's defeat.
- Shifting the loyalty of hostile forces and their supporters to a friendly power.

In conflicts short of war, the commitment of general purpose combat forces may be premature, inappropriate, or infeasible. It may also increase the risk of further escalating the conflict to an unacceptable level. In these situations, PSYOP offer the NCA options for engagement without general purpose combat forces. (See Figure 1-2.)

During Operation Just Cause in Panama, PSYOP planners designed consolidation programs to encourage support for U.S. goals. PSYOP also involve foreign internal defense (FID) missions to enhance the military capabilities of U.S. allies in the region. In the aftermath of war or conflict, consolidation PSYOP help in returning an area to normalcy. Consolidation PSYOP help military operations by reducing interference from non-combatants and by gaining the populace's cooperation.

War

The NCA may direct a unified command CINC to conduct PSYOP. In war, PSYOP support tasks at the strategic, operational, and tactical level may influence any part of the battlefield areas.

The strategic supporting role of PSYOP during war focuses on the hostile power's long-term capacity to continue fighting. For example, PSYOP actions may help U.S. strategic foreign policy in achieving stability in the Middle East by projecting an ongoing presence there.

At the operational level, theater PSYOP actions aided the unified commander's theater campaign plan during operations Desert Shield and Desert Storm. This aid included, among other things, support of the operational deception.

STABILIZATION

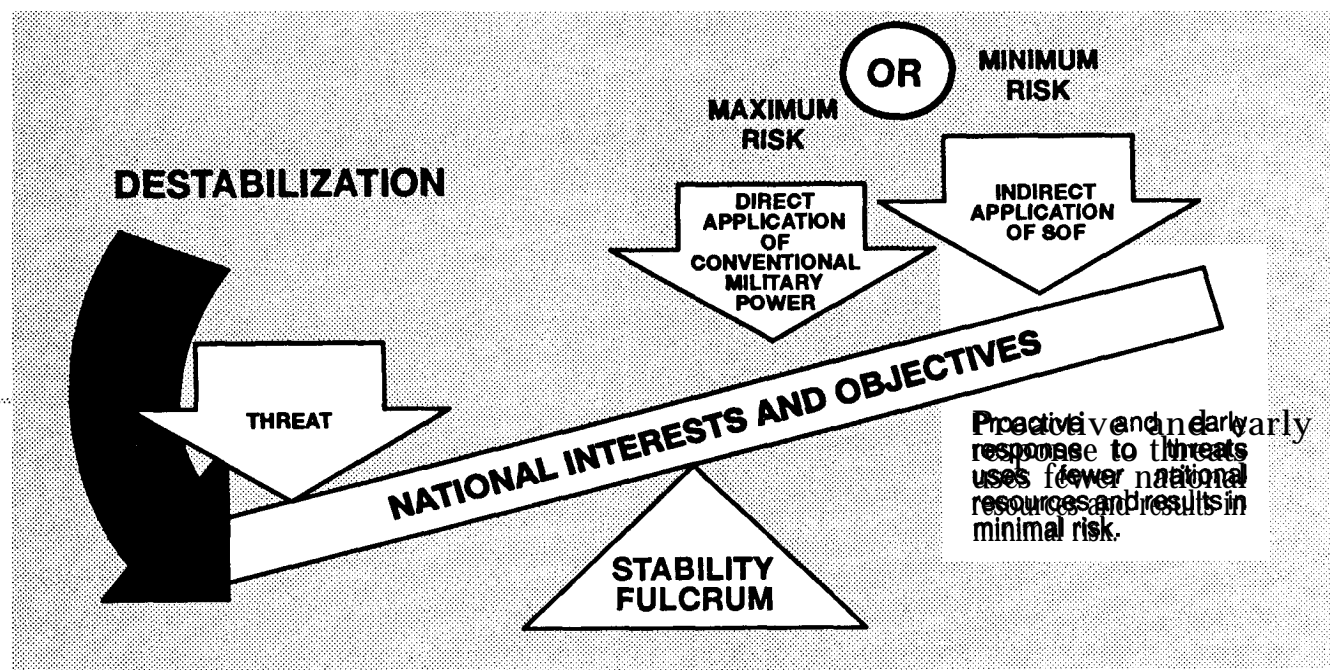

Figure 1-2. National response.

Tactical PSYOP actions during operations Desert Shield and Desert Storm included safe conduct passes and surrender appeals

dropped as leaflets from aircraft on Iraqi forces facing the coalition forces.

BLUEPRINT OF THE BATTLEFIELD

The Army has adopted a blueprint of the battlefield for the tactical, operational, and strategic levels of war (see TRADOC Pam 11-9). This blueprint depicts military operations by functional areas and describes three operating systems: battlefield operating systems (BOS), theater operating systems

(TOS), and global operating systems (GOS). Appendix D describes these systems further. Figure 1-3 portrays the BOS in which PSYOP are considered a form of fire support. The blueprint provides a tool for mission analysis and the definition of requirements in the battlefield development plan.

THE PRINCIPLES OF WAR

PSYOP commanders, coordinators, and planners apply the principles of war to support joint, combined, interagency, and special operations (SO). Before they apply these principles, however, they must consider the operational environment and force capabilities. PSYOP are more sensitive to nonmilitary factors than are conventional operations.

PSYOP units offer unique capabilities such as language-qualified personnel, personnel familiar with the target audience, and personnel who can operate media equipment. PSYOP apply the nine principles of war—

- *Objective.* Direct every military operation toward a clearly defined, decisive, and attainable goal.

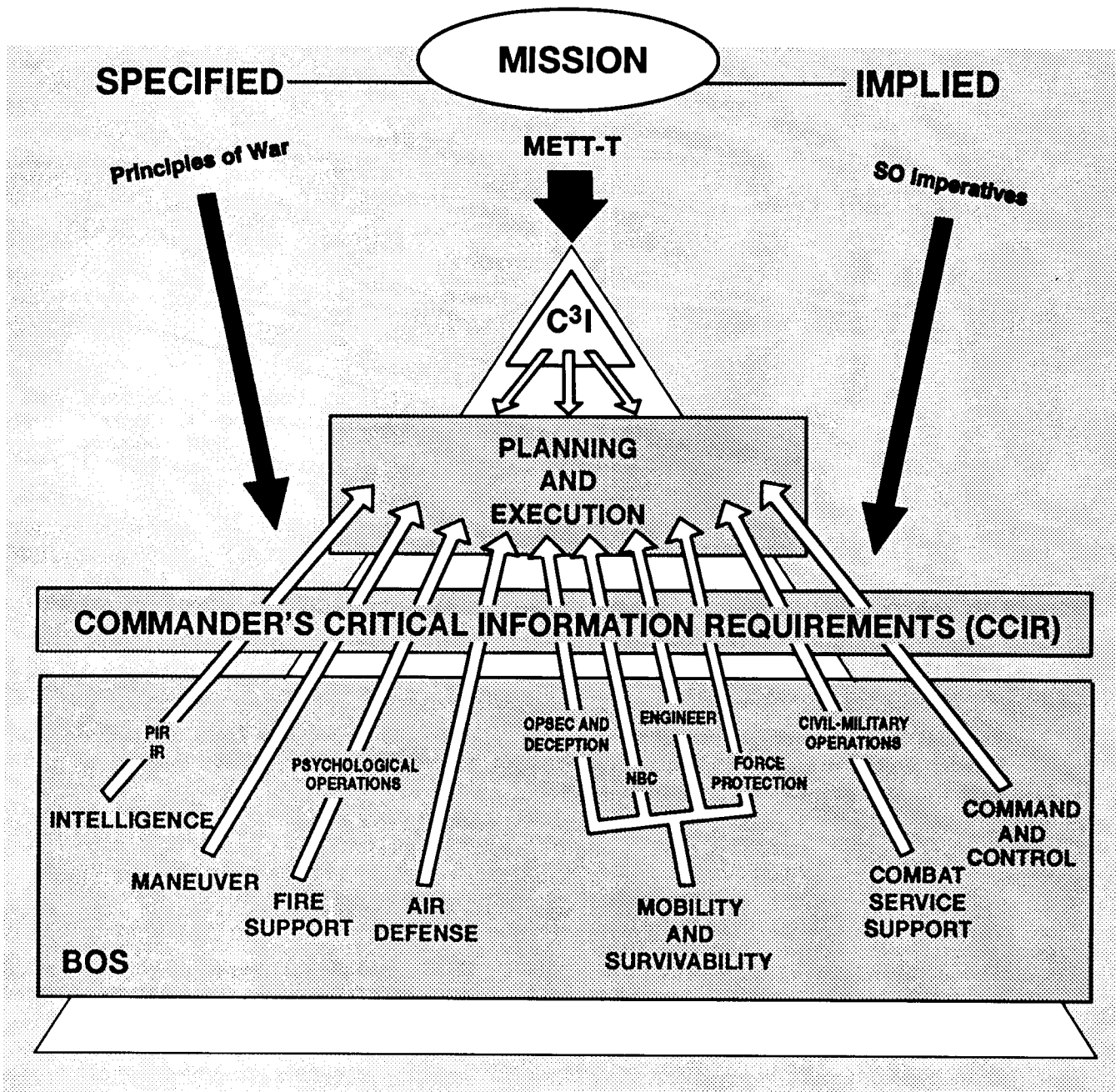

Figure 1-3. Battlefield operating systems.

- *Offensive.* Seize, retain, and exploit the initiative.
- *Mass.* Concentrate combat power at the decisive place and time.
- *Economy of Force.* Allocate minimum essential combat power to secondary efforts.
- *Maneuver.* Place the opponent in a position of disadvantage through the flexible application of combat power.
- *Unity of Command.* For every objective, ensure unity of effort under one responsible commander.
- *Security.* Never let the opponent get an unexpected advantage.
- *Surprise.* Strike the opponent at a time or place or in a manner for which he is unprepared.
- *Simplicity.* Prepare clear, uncomplicated plans and clear, concise orders to ensure thorough understanding.

Objective

In war, PSYOP goals usually focus on hostile military vulnerabilities. In conflict, they may focus on economic or political objectives, as well as military vulnerabilities. In peacetime, they may lead directly to accomplishing theater objectives. However, PSYOP objectives must always support national goals.

Offensive

The supported commander must include PSYOP in the planning stages of offensive operations. The use of PSYOP as an afterthought often yields an ineffective PSYOP program. PSYOP personnel must work closely with the supported unit's operations and training officer (S3) to make sure the operations include battlefield psychological activities (BPA). The type of offensive operation influences the type of combat support from PSYOP forces.

Mass

PSYOP usually support the principle of mass during conventional operations rather than during SO. For example, loudspeakers may broadcast the sounds of maneuvering tanks to portray a force larger than the actual force. PSYOP forces do not mass together to bring overwhelming combat power against a target. Instead, the synergistic effect of combat formations and psychological actions acts as a combat multiplier. Additionally, a supported commander may concentrate PSYOP sections or teams to increase the potency of PSYOP actions.

Economy of Force

When PSYOP are part of military operations, they increase the chances of a successful mission. The supported commander can reach his objectives by using PSYOP as a force multiplier with other BOS. PSYOP, as a nonlethal fire support element, can help reduce the number of noncombatants and decrease armed resistance to U.S. operations.

Maneuver

PSYOP units do not maneuver against an opponent in the classic sense. Once committed, PSYOP units often lack the opposing force's tactical mobility and reinforcement capability. A PSYOP commander may use various PSYOP actions to aid his supported commander in maneuvering his forces. One way is to use loudspeakers to clear civilians from main supply and advance routes.

Unity of Command

The Psychological Operations Task Force (POTF) or the Psychological Operations Task Group (POTG) in the senior supported command's headquarters designs and orchestrates the overall PSYOP campaign and supporting PSYOP programs to achieve unity of command. See Chapter 5 for more details on organization. PSYOP units often work with other government agencies to plan operations. PSYOP commanders must synchronize their activities with nonmilitary members of the country team, for example.

Security

At the tactical level, security is essential in protecting and managing combat power. All PSYOP personnel must know security measures outlined in the standing operating procedures (SOPS) of their units and supported units. Supported units' SOPS often take precedence. PSYOP units develop PSYOP awareness programs (PAPs) for supported units to help reduce susceptibility to hostile propaganda. PSYOP support to deception enhances security.

Surprise

The United States can achieve a degree of psychological surprise with its strategic deployment capability. Rapid deployment of U.S. combat forces into a crisis area may forestall or upset the opponent's plans and preparations. This capability can give the United States a physical and psychological

advantage by denying the opponent the initiative. PSYOP that support deception plans can enhance the principle of surprise by giving credence to feints and ruses. PSYOP can achieve surprise when the enemy has a weak or nonexistent PAP. When target audiences are not preconditioned to avoid or distrust our messages, the impact of those messages is magnified.

Simplicity

PSYOP plans and procedures must be simple and direct. The stress and confusion of changing situations can disrupt complex, rigid plans. Clear, concise operation plans (OPLANs), operation orders (OPORDS), and appendixes reduce misunderstanding and confusion.

PSYOP PROGRAMS

A PSYOP program includes products, actions, or a series of both, designed to produce a desired behavior in a specific target audience. A series of PSYOP programs form the PSYOP campaign that supports the senior commander's overall goals. A PSYOP program's purpose is to channel a target audience's behavior toward the support of U.S. goals. In practice, national goals determine the use of PSYOP programs. These goals may be political, economic, military, social, ideological, or religious. They are a means by which the United States seeks to maintain or redistribute power. Projection of power requires a series of management decisions from the NCA on strategic policy to tactical-level techniques by PSYOP personnel. From policy to technique, the basic planning considerations are the same. The PSYOP program supporting national goals must be reasonable, timely, and achievable. PSYOP programs include action programs, product programs, or product and action programs.

Action Programs

These programs are sequential, coordinated activities that may include military operations conducted for their psychological impact. Examples of action programs range from a civil affairs (CA) unit drilling a well for humanitarian assistance to an aircraft carrier sailing off the coast for a show of force. Only the supported unit's limitations in performing the action and the PSYOP planner's imagination restrict the variety of psychological actions. All psychological ac-

tions require close coordination with other Services and agencies to ensure proper timing, coherence, and economy of force. Units conducting action programs provide an extra dimension to the overall psychological program. Properly planned, coordinated, and integrated psychological actions help PSYOP personnel capitalize on the success of the actions. They then use that success to influence the target audience's behavior. Commanders and planners must remember that all actions have a psychological impact, even those not intended to be a part of action programs.

Product Programs

Product programs are sequential, coordinated presentations of visual, audio, and audiovisual products designed to enhance the effects of psychological actions. A product must attract the audience's attention and convey the intended meaning. The product must also lead the target audience in a direction that accomplishes the psychological objective and the PSYOP mission. Whatever form it takes, the product must accomplish its tasks independently.

Product and Action Programs

These programs are sequential, coordinated actions and product presentations that synchronize their respective effects to produce a desired behavior in a specific target audience. The produced behavior or attitude must support the supported commander's overall objectives.

Chapter 2

T h r e a t s A n d N a t i o n a l S e c u r i t y

The international security environment has recently undergone a basic change from a bipolar balance of power to a multipolar power structure. The breakup of the Soviet Union resulted in a new world order in which superpower domination is reduced. This situation has reduced the chance of war between the former Soviet Union and the United States, notably in central Europe.

The risks of other conflicts stay high and may even have increased, as shown by recent events in the Persian Gulf. Terrorism, insurgency, and subversion can still directly affect U.S. national security goals. Over time, the cumulative effect of these events can gradually isolate the United States from its allies and global trading partners. These events can weaken the political and economic institutions of the world. These events can also reduce U.S. access to strategic resources and impair U.S. military basing, transit, and access rights. Finally, these events can shift associates and allies into positions favoring interests that threaten those of the United States.

The changes in the strategic environment resulted in what the President has called the two greatest threats to post cold war America: uncertainty and instability. The effective use of PSYOP can contribute to countering these threats.

T Y P E S O F T H R E A T S

Changes in the strategic environment have inevitably led to changes in the threat to psychological operations. To understand the application of PSYOP doctrine, the implementation of the PSYOP planning process, and the development of effective PSYOP programs of products and actions, we must understand the specific threats to PSYOP.

Threats to PSYOP are any person, institution, or environmental factor that presents an identifiable, recurring obstacle to the-

- Success of a PSYOP program.
- Execution of the commander's mission.
- Achievement of national policy objectives.

These threats must be identified and considered a part of the PSYOP planning process.

Although these threats are significant, PSYOP can convert identified threats to advantages. A thoroughly developed and well-implemented PSYOP program can exploit any factor and fulfill PSYOP goals, particularly in a multipolar world. By the same token, failure to identify and analyze the threats to PSYOP could result in uncertainty and instability. Uncertainty and

instability, in turn, can bring about failure to fulfill critical PSYOP goals that could lead to direct threats to U.S. national security.

The three principal threats to PSYOP—conflict environment, technical environment, and the social and political environment—are interrelated. (See Chapter 8, Figure 8-1.) These threats have the potential to block or degrade the effectiveness of U.S. military PSYOP.

CONFLICT ENVIRONMENT

Before the former Soviet Union's break up and the resulting changes in the bipolar, superpower confrontation, the main threat to PSYOP was the Soviet PSYOP capability applied directly by that government or through client states. Soviet PSYOP included disinformation campaigns. These campaigns often appeared to American audiences to lack technical sophistication. They sometimes fell short of their clear objective. They were, however, carefully aimed at specific target audiences. The apparent lack of finesse was part of their appeal to the specific audiences.

The threat of an organized Soviet PSYOP campaign directed from Moscow has largely diminished. However, the threat of Soviet-style PSYOP campaigns directed at the United States has actually increased. Many former Soviet client states may still hold national goals that are at odds with U.S. national goals. Their principal weapon may be PSYOP programs based on the doctrine, tactics, techniques, and procedures previously used by the Soviet Union. For example, in the months leading up to the start of Operation Desert Storm, the Iraqis

used Soviet-style disinformation as part of a divisive PSYOP program aimed at the coalition forces.

The conflict environment threats are not limited to PSYOP practices based on the Soviet model. With the end of the bipolar world, others will surely vie for the chance to advance their national, regional, or global goals. These goals could range from a nation using its military and economic power to ensure control of regional resources to an ethnic group seeking a secure and independent homeland. The type of PSYOP used may be either Soviet or U.S. PSYOP methods. The type of PSYOP used may also come from deeply rooted traditional culture and religious practices. It may not even be formally acknowledged as a PSYOP program. However, it has the same goals of any PSYOP program—to channel the behavior of individuals to reach a specific goal. An analyst must view such a program as a conflict environment threat to PSYOP. He must evaluate and consider this program in the PSYOP planning process and in product development.

TECHNOLOGICAL ENVIRONMENT

The rapid development and dissemination of communications technology has impacted

on the conduct of PSYOP. Just as this new technology provides U.S. PSYOP forces with

new opportunities, it can be a threat that analysts must identify and consider in the PSYOP planning process.

Just as U.S. psychological operations exploit all appropriate technology, potential opponents will try to do the same. The most modern forms of communications technology are no longer limited to modern, industrial nations. Facsimile (FAX) machines, portable video cameras and cassette players, electronic mail, and satellite communications are almost universally available. During the 1991 Soviet coup, FAX machines owned by companies and individuals often provided the United States with real-time views of events in Soviet cities. Persons recorded the invasion of Kuwait on privately owned video cameras. Potential opponents have instant access to these resources with little or no cost.

In addition to low-cost, high-density, easily accessed communications resources, many nations have electronic and counterelectronic warfare assets that could block or degrade U.S. psychological operations. All PSYOP planning must evaluate and account for this threat.

Finally, although technology is available, methods of use and audience expectations are not universal. Americans used to over 30 years of color television and sophisticated video production techniques might give little respect to dated production techniques used in nations where television has only been available to the masses for less than 10 years. The opposite is also true. PSYOP planners must consider the masses' expectations of the technology.

SOCIAL AND POLITICAL ENVIRONMENT

The recent political upheavals may have dramatically changed the structure of certain political institutions. They have not, however, altered individual attitudes. They may temporarily alter certain life-style factors that directly affect a target audience's receptiveness to the PSYOP message.

Studies of threats to PSYOP must include an evaluation of economic, cultural, and

political factors that affect individual behavior. Some may be temporary factors that result from disruptions to normal marketplace practices or changes in leadership. For example, prices for food may be unusually high, or police service may be disrupted. Other factors may be deeply held, long-standing beliefs. Regardless of the basis for these factors, they are all potential threats to the success of a PSYOP program.

Chapter 3

PSYOP Missions

Operational planners at all levels integrate all force multipliers. As a force multiplier, PSYOP support commanders at all levels of command. PSYOP specialists provide liaison, planning, coordination, and equipment support to execute psychological programs. When the PSYOP commander receives a mission, he considers several factors before issuing warning orders or making an estimate of the situation. He considers the mission, enemy, terrain, troops, and time available (METT-T), as discussed in FM 100-5. The PSYOP commander relies on his PSYOP experience and the advice of his staff. He weighs his forces' capabilities and prioritizes their missions. His mission priority list, as part of the PSYOP plan of support, ranks at the top of those missions that have the best chance of achieving the national, PSYOP, and supported commander's goals.

MISSION

Army PSYOP forces plan, conduct, and support three interrelated PSYOP missions: strategic PSYOP, operational PSYOP (including EPW, counterintelligence [CI], and PSYOP consolidation operations), and tactical PSYOP. All psychological operations are designed to support U.S. national policy. Army PSYOP forces maintain special relationships with designated defense organizations and civilian government agencies (Department of State [DOS], U.S. Information Agency [USIA], and the U.S. Agency for International Development [USAID] among others). In addition to supporting U.S. and allied military operations, PSYOP support may be extended to other government agencies and, as directed, to specified friendly governments. PSYOP units are also

capable of providing PSYOP training, advice, and help to U.S. and friendly forces and agencies. PSYOP staffs and commanders review, plan, and coordinate military activities having a psychological impact on the operational area.

Advising Supported Commanders and Staffs

PSYOP personnel must be assertive in promoting PSYOP as a force multiplier. They must continually advise supported commanders and staff members of target-audience-specific information such as vulnerabilities and susceptibilities. They make sure the supported commander recognizes

all mission capabilities of available PSYOP assets. They advise supported commanders and staffs on the psychological impacts of their courses of action (COAs). They identify the enemy PSYOP efforts and the susceptibilities of friendly forces.

Developing, Producing, and Disseminating Programs

PSYOP units develop, design, produce, and disseminate programs that support tactical, operational, and strategic goals. PSYOP planners choose the product, action, or a combination thereof most likely to influence the target audience.

Coordinating and Directing PSYOP Program

PSYOP must follow national policy goals with programs developed and approved by higher headquarters. Coordination of PSYOP programs takes place up and down the PSYOP chain of command to ensure the credibility of the programs. OP3 is an example of the

coordination needed for a viable integrated interagency and Service PSYOP program that supports national goals and the supported unified command.

Producing PSYOP Studies and Estimates

The senior PSYOP planner at each command level oversees the production and revision of PSYOP studies and estimates. Each PSYOP planner maintains a log of lessons learned in each PSYOP program as a reference for future programs.

Advising and Helping Host Nations

The primary U.S. aim for host nation (HN) assistance is to sustain internal security that permits economic, political, and social growth. During civil-military operations (CMO), PSYOP personnel may work with CA personnel who provide HN support through development programs.

OPERATIONS

PSYOP may support joint and combined operations, contingency operations, deception operations, and consolidation operations.

Joint and Combined Operations

PSYOP units normally support joint operations at the unified command or joint task force (JTF) level. Unless the JTF is larger than a corps, a PSYOP battalion task force can support it. The PSYOP commander normally serves in a dual role, as the PSYOP task force commander as well as the principal PSYOP staff officer. For amphibious operations when the JTF headquarters remains aboard ship and ground operations have commenced, the PSYOP unit executive

officer remains aboard, serving as the JTF PSYOP staff officer. The PSYOP task force commander, in turn, directs his troops while operating with the senior ground force commander.

During joint or combined operations, the theater CINC establishes an information coordinating committee (ICC) to oversee the overall dissemination of information (to include PSYOP). This committee ensures the integration of all available PSYOP assets, including nonmilitary agencies (U.S./coalition). Members of the committee may include the following personnel:

- Senior PSYOP staff officer.
- Joint/combined operations officer (J3/C3).

- Political advisor (POLAD).
- Public affairs officer (PAO).
- Joint/combined plans officer (J5/C5).
- Legal advisor.
- United States Information Service (USIS) representative.
- Representative from each Service.
- Country team representative.

For more information on joint operations, refer to Joint Pub 3-53 and Chapter 5 of this manual.

Contingency Operations

Contingency operations focus on specific problems that usually require rapid solutions. These operations are managed at the highest level of government. They are normally short-term, politically sensitive operations that use joint or interagency forces tailored for the specific mission.

Contingency operations always have a strong psychological impact on the target audience. For example, attacks on terrorist sanctuaries can reinforce the U.S. Government's resolve to punish violations of international law. PSYOP programs may be used to promote the U.S. standpoint and fix the blame on the terrorists.

Effective PSYOP programs exploit opponent vulnerabilities and win the support of selected target audiences. They are flexible enough to handle peacetime contingencies, yet allow for operational security and coordination between civilian and military authorities. An effective PSYOP program prepares a host nation for the use of U.S. forces without compromising the mission.

Deception Operations

The following paragraphs address the levels of and the PSYOP capabilities in support of deception operations. Also covered are

support for offensive and defensive operations and coordination of PSYOP deception support.

Levels

Usually, strategic, operational, and tactical PSYOP support the proper level of deception used on the battlefield. Strategic deception may extend political deception by using military activities. Operational deception often overlaps strategic and tactical deception. Deception is an inherent part of the campaign plan. Tactical deception supports tactical maneuvers, misleading and inducing the opponent to do something counter to his interests. They may support operational or strategic deception efforts. FM 90-2 discusses battlefield deception in depth. PSYOP can support the deception plan of both general purpose forces and SOF.

Capabilities

Deception is a classic example of an important principle of war—economy of force. PSYOP personnel using special equipment and PSYOP techniques can markedly enhance deception operations. Deception uses feints, demonstrations, ruses, and displays.

PSYOP personnel and units have inherent capabilities and requisite skills that make them ideally suited to support the planning and execution of deception operations. The chance of success and the impact of deception operations increase when PSYOP support the deception plan. Analyses, studies, pertinent intelligence holdings, environmental indicators, and other related data are reviewed and selectively converted into PSYOP support materials suited to deception actions.

A significant PSYOP contribution to deception may be in assisting commanders to anticipate the opponent's actions. PSYOP personnel analyze all friendly actions that try to influence opponent behavior. They then evaluate the opponent's reactions to determine if the friendly actions influenced or deceived him. In addition, the active PSYOP group may prepare a basic PSYOP study (BPS) or a special PSYOP assessment

(SPA) that contains the opponent's cultural, social, and political factors. By knowing these influencing factors, PSYOP personnel can provide valuable input for deception planning.

Each deployed PSYOP unit is task-organized and has linguists and organic PSYOP equipment that can support deception operations. PSYOP personnel may use printing and photographic assets to produce a variety of notional material. Examples of these materials include excerpts from order of battle documents, unit movement orders, posters, and various directives for dissemination to the populace. PSYOP personnel can also use radio and television (TV) broadcast assets to disseminate national information. Radio transmitters can break into opponent radio programs and give false news reports to create confusion and chaos in the target audience. Using taped sound effects such as sounds of armored vehicles on loudspeaker systems can provide excellent audio deception support.

Support for Offensive Operations

Surprise is usually a key factor in offensive operations. It is not, however, always possible to maintain secrecy while planning a large-scale attack. A deception effort can help by causing the target to believe an attack will occur in a particular location. This belief could cause the opponent to relocate forces. PSYOP can support this type of deception operation through—

- Directives or posters stating that a specific area and the roads leading to it are off-limits.
- Deliberate rumors about an upcoming attack, the units involved, and other information to support the deception story.

Support for Defensive Operations

Only the deception planners' imagination and the availability of equipment limit PSYOP support to deception operations.

PSYOP units in direct support of corps and divisions can support deception activities down to the lowest maneuver element.

Coordination

The PSYOP unit commander and the supported unit operations and plans (G3) officer (joint operations and plans [J3] officer) coordinate the use of PSYOP assets to support the overall deception plan. Early planning ensures the incorporation of the proper PSYOP assets in the deception plan.

The PSYOP unit commander determines and advises the G3 and J3 if overt involvement in the deception operation is in conflict with overall PSYOP goals. The commander should also be aware that overt PSYOP involvement in deception operations may damage PSYOP credibility in the target audience's eyes. The supported unit commander approves or disapproves the use of approved PSYOP themes and dissemination techniques before using them in the deception operation. The success of deception operations increases when PSYOP personnel plan, coordinate, and operate with battlefield deception personnel.

Psychological Aspects

Perception, the interpretation of sensory input, makes an individual aware of the stimuli around him. An individual's interpretation of the sensory input depends on his experience and learning. His motives, expectations, and attitudes also affect his interpretation. A person can perfectly perceive things around him, or he may misinterpret the sensory input and thus misperceive. Misperception is a psychological phenomenon. It can occur by self-induced misinterpretation or deliberate misperception caused by others' deception. A self-induced misperception usually occurs when an individual lacks experience or does not interpret the sensory input objectively.

Since misperception is a psychological phenomenon, the deception planning process not only focuses on the target's (opponent commander's) but also on his advisors' (the commander's staff) psychological profiles.

The steps associated with deception planning include-

- Ways to conduct the overall mission (for example, to effect a landing or to conduct a contingency operation).
- Ways the target should react to the deception in a given situation.
- What the target should think (perceive) about the planned events.
- What to hide (or dissimulate) and what to show (or simulate).
- Ways to carry out the dissimulation and simulation tasks to obtain the desired effects (for example, how to deceive).
- Ways to discern the means available to present the separate elements of deception to the target. A deception occurs when an individual accepts and interprets false data at face value. In addition, the presented deception elements must fit a particular situation and target audience's experience and learning.
- Ways to carry out the deception operation.
- Ways to collect feedback to monitor the target's responses to the deception and to make changes in the deception operation, if applicable.

By coordinating with attached or supporting PSYOP personnel, deception planners can include useful guidance into the psychological aspects of deception. The planners make sure the deception elements attract and hold the target's attention. In addition, the presented deception elements must fit a particular situation and target's experience and learning. To carry out successful deception operations, planners must be proficient in countering an opponent's potential counterdeception.

Consolidation PSYOP

Consolidation PSYOP take place in foreign areas to support U.S. activities throughout the operational continuum. Consolidation

PSYOP include support of military consolidation operations during the reconstitution phase of military operations and the support of peacetime activities. Consolidation PSYOP is nonlethal fire support that needs preplanning for all activities in foreign areas. Consolidation PSYOP are directed toward populaces in friendly areas of operations (AOs) or in territory occupied by friendly military forces. Their objective is to facilitate operations and promote maximum cooperation in the populace to support U.S. goals in the area.

Theater Commander Responsibilities

The theater commander is responsible for consolidation operations. These operations are directed toward populaces in either liberated or occupied areas. Consolidation PSYOP try to influence the populace to make military operations easier. Consolidation operations also seek to promote maximum cooperation with the liberating or occupying power. The theater commander tasks the theater Army (TA) commander to administer and rehabilitate occupied or liberated territory. PSYOP support consolidation operations at both the operational and tactical level by gaining support for U.S. and coalition military operations. They gain this support by reorienting and reeducating the populace on the commander's goals, policies, and missions. Consolidation PSYOP induce or reinforce attitudes and behavior favorable to U.S. national goals in selected foreign target audiences.

Organization

If the theater Army area command (TAACOM) covers a large area, it may be subdivided for ease of control. Corps commanders conduct consolidation operations in their area of responsibility (AOR) with resources provided by the TA.

PSYOP units supporting consolidation operations during the reconstitution phase of hostilities are OPCON to the CA command. They supplement organic CA elements, such

as civil information sections or teams. These CA and PSYOP teams—

- Conduct PSYOP through mass media and face-to-face communications.
- Supervise or advise indigenous personnel on the use of PSYOP through local communications media.
- Provide PSYOP support for rear area protection operations and civil defense.

PSYOP Goals

PSYOP goals in consolidation operations vary with the area, the populace, and the supported CA unit's mission. PSYOP' primary goals are to get support for military operations and to orient and reeducate the populace in accordance with (IAW) command policies, goals, and missions.

Peacetime Activities

PSYOP support the presence of U.S. forces or personnel in foreign areas during peacetime by inducing or reinforcing attitudes and behavior that support U.S. national goals and policies.

Orientation and Reeducation

PSYOP' major goal in supporting consolidation operations is to orient and reeducate the populace. PSYOP personnel follow higher headquarters policy and direction for consolidation operations. They advise and help prepare plans, programs, and operations to indoctrinate and reeducate the populace in areas under U.S. and allied control.

The aim of these programs is to—

- Develop understanding and favorable attitudes in the populace toward our military forces.
- Gain local support for the military effort.
- Help attain all allied goals.

The population's orientation and reeducation begin as early as possible and may run concurrently with the combat support mission. Publicizing CA and other activities that benefit the populace and explaining U.S. and

allied intentions vis-a-vis the liberated or occupied areas help promote these programs.

These programs try to eradicate doctrines and practices hostile to U.S. goals. These programs also seek to end the influence of hostile individuals and groups. Orientation and reeducation continues throughout the occupation. psychological action is a major tool of orientation and reeducation.

Psychological actions try to influence the target's actions and attitudes. psychological actions can be effectively used with information programs. When combined, their effectiveness increases. Properly publicized and planned psychological actions are more effective than the word alone.

U.S. PSYOP elements will not activate or implement PSYOP against an indigenous population when U. S., allied, or host country agreements prohibit such activities.

Other Objectives

In consolidation PSYOP, there are some goals, other than those mentioned above, that do not involve PSYOP dissemination. For example, PSYOP elements-

- Search for media and personnel.
- Disseminate news.
- Collect information.
- Gain willing cooperation.
- Make the military situation known.
- Capitalize on existing habits.

Search for media and personnel. A PSYOP task may be to locate indigenous communications media, equipment, supplies, and personnel. Another task may be to locate key communicators and influence groups within the society.

Disseminate news. The media must keep the people informed. Credible information that the press, radio, and TV transmit is useful for political indoctrination in an orientation and reeducation program. PSYOP elements may assist in this program.

Collect information. Information obtained from local people is valuable in evaluating

their “temper” and attitudes. This information helps to define the nature and content of PSYOP consolidation program.

Gain willing cooperation. Intimidation stemming from the presence of strong military forces may temper hostility and make the populace more responsive to authoritative direction. Positive, well-publicized psychological programs (actions and products) must convert intimidation into long-lasting, willing cooperation. In occupied or liberated areas, minority groups who have humbled themselves for a long time because of race, religion, ethnic background, or socioeconomic status will often have feelings of inferiority. In an area recently subjected to total war, civilians are usually weary, apathetic, and in a state of shock. These conditions often make them unable to resist authority, thus easing control through PSYOP. In a newly liberated or occupied area, civilians normally depend on the occupying power because it supplies vital goods and services. For reasons of self-interest, therefore, these people may be willing to assist the PSYOP program.

Make the military situation known. If the populace has favorable information about the occupying forces’ military situation, it tends to be more cooperative. PSYOP can exploit this tendency.

Capitalise on existing habits. People are used to receiving news and information through specific, well-known, and established sources and media. They more readily believe and follow information and directives received through these sources and media. The PSYOP consolidation program capitalizes on these existing habits by using familiar sources, media, formats, and style.

Planning Considerations

PSYOP resources are used to transmit information and directives to the population. However, there are fundamental differences affecting consolidation operations in liberated and occupied territories. In liberated

areas, PSYOP are persuasive, while they may be arbitrary and directive in occupied areas. The demands of combat and the need for control, however, may require equal treatment of the people in—

- Liberated areas.
- Occupied areas.

Liberated areas. The military situation, U.S. policy, and international and inter-allied agreements will govern activities in liberated areas. Agreements will normally prohibit U.S. forces from targeting the inhabitants of liberated areas with PSYOP beyond the time dictated by military need. The agreements may include a proviso that U.S. forces train, advise, and assist the friendly government and its forces. In these circumstances, U.S. PSYOP elements will not actively engage in PSYOP directed at the indigenous populace in the friendly territory. Instead, they will advise, train, and assist the friendly government or its forces, based on U.S. Army PSYOP doctrine, techniques, and procedures.

Occupied areas. In occupied areas, PSYOP help implement civilian reeducation and re-orientation programs. The process to eradicate unacceptable ideological practices and influences continues throughout the occupation.

PSYOP personnel must also consider the following factors when planning and conducting consolidation operations:

- Continuity.
- Consistency with postwar aims.
- Relation to the U. S. information program.
- Relation with friendly underground.

Continuity. PSYOP in liberated and occupied areas are carried out as a unified, continuously evolving program throughout the military occupation. The preparation of PSYOP plans that support consolidation operations takes place as early as possible (the overall plan, before the occupation; subordinate plans, as soon as the tactical situation permits).

Consistency with postwar aims. Consolidation operations planning must be consistent with postwar aims. The PSYOP planner must avoid making commitments for short-term gains that may not fit long-term policies.

Relation to the U.S. information program. Consolidation operations must correlate with the U.S. Government's information program and must follow directives guiding that program.

Relation with friendly underground. PSYOP personnel make every effort to coordinate with and get the cooperation of friendly guerrilla and resistance organizations on the use of PSYOP programs. Such actions help eliminate counterproductive PSYOP and achieve common goals effectively.

Attitudes

The initial consolidation effort is perhaps the most difficult since the populace's attitudes may not be fully known. Target analysis can uncover these attitudes. Understanding them helps the operator plan consolidation operations and increases their effectiveness. The planner needs to examine attitude—

- Toward occupying forces.
- Toward accepting discipline or control.
- Shaped by proximity of the opponent.
- Based on opponent propaganda.
- Created by organized resistance groups.

Attitudes toward occupying forces. Liberated populations normally have more friendly attitudes toward the liberating forces than those in occupied areas have for the occupying forces. The PSYOP planner must determine the tenor and intensity of the populace's attitudes to deal effectively with them.

Attitudes toward accepting discipline or control. People accustomed to totalitarian methods may respond favorably to authoritarian controls. People familiar with a democratic way of life may require persuasion rather than discipline.

Attitudes shaped by proximity of the opponent. When opponent forces are near occupied or liberated areas, the population will fear their return and give minimal cooperation to consolidation operations. On the other hand, if the opponent is far away and unlikely to return, both friendly and hostile persons are more likely to cooperate in the consolidation effort.

Attitudes based on opponent propaganda. In liberated and occupied areas, the opponent will seek to advance his own views through intensive propaganda. PSYOP consolidation operations planner must learn the source and effectiveness of opponent propaganda to make his own more effective.

Attitudes created by organized resistance groups. When organized resistance groups exist in liberated or occupied areas, their presence and actions against occupying forces greatly influence the populace.

Obstacles

The following are some conditions that may hinder consolidation operations:

- Resentment against occupying forces.
- Ideological differences.
- Military misconduct.
- Devastation and disruption of communications.
- Opponent.

Resentment against occupying forces. Antipathy toward occupying forces may cause resistance in the form of disruptive behavior, even rebellion.

Ideological differences. The PSYOP planner may find himself dealing with staunch adherents to ideologies hostile to his own. In conquered territory, these hostile ideologies may foster the formation of resistance groups. In liberated areas, dissident elements may undermine the occupation. To be effective, the PSYOP planner must understand existing ideological differences. Then he must develop his program to deal with the realities of the situation.

Military misconduct. Occupation forces who lack dedication and do not understand their mission often engage in acts that discourage cooperation by the people. To eliminate misconduct and improve understanding of the mission, the individual soldier must understand the mission's goals. His actions and attitude must win the favor of the people. Although PSYOP cannot be directed at U.S. personnel, PSYOP personnel make the commanders aware of specific tension-producing conduct and the reasons for the public attitude.

Devastation and disruption of communications. Consolidation operations depend on communications. When communications are destroyed or disrupted, it is hard to inform and control civilian populations. Due mainly to the lack of current information, disrupted communications affect face-to-face communications as well as their mechanical forms (radio and newspaper). PSYOP personnel with their equipment and expertise may lessen the problems caused by disrupted communications.

Opponent. Although forced from the area, the opponent may continue to direct propaganda at the populace. By this action, the opponent may hold some members and perhaps gain new ones to its cause. PSYOP personnel help counter the effects of opponent propaganda. The best PSYOP program is one that combines PSYOP of the word with PSYOP of the deed.

PSYOP Capabilities

Whether implemented by U.S. PSYOP elements, the HN government and its forces, or other allies, PSYOP can assist the supported commander by—

- Establishing law, order, and discipline.
- Securing lines of communications.
- Controlling dislocated civilians.
- Marshaling labor.
- Collecting information.
- Controlling rumors.
- Publishing news.
- Providing entertainment

Establishing law, order, and discipline. The organization of populated areas involves the prudent use of PSYOP. PSYOP' aims are to calm the people's fears, to prevent aimless panicky movement, and to direct their activities into useful channels. PSYOP help to create a state of mind favorable to establishing law and order. PSYOP condition the populace to accept imposed controls and restrictions willingly. This acceptance reduces the number of troops required to pacify and control the populace.

Securing lines of communications. Operations require force mobility. Main lines of communications (LOC) must be kept open for the flow of military forces, equipment, fuel, and other supplies.

Controlling dislocated civilians. Refugees, evacuees, and displaced persons frequently clog military arteries, hindering the movement of combat units and equipment. PSYOP units help the area commander keep his LOC open by publishing and broadcasting information and instructions.

Marshaling labor. PSYOP units, in coordination with CA units, help publicize labor needs among the populace and direct potential workers to proper labor offices.

Collecting information. PSYOP personnel gain information of value to the intelligence (G2 or S2) officer and the PSYOP effort through close contact with friendly and hostile persons. PSYOP personnel make sure to put such information in intelligence channels. PSYOP personnel also develop and disseminate appeals to the people by encouraging them to report information on opponent activities.

Controlling rumors. The psychological state of a combat zone's inhabitants makes them vulnerable to rumors. These rumors may stimulate undesired actions (or inactivity) that may interfere with combat operations. A timely, accurate, and well-managed information program will counter false rumors.

Publishing news. News is valuable to support PSYOP goals in consolidation. Local news of the military occupation and the progress of the war and world news on political, educational, religious, economic, and scientific matters are relevant and of increasing interest to the population.

Providing entertainment. In either liberated or occupied areas, PSYOP units can work with Army bands and local ethnic entertainers and other entertainment media (films, radio, TV) to provide a wide range of entertainment to people lacking such diversion due to war damage. Whether presenting pure entertainment or mixing it with

messages, any momentary relief from the realities of the situation will help gain the people's cooperation. It will also give them a moment of respite from the ravages of war, occupy their time, and distract them from their fears and worries. Such presentations will help to create a climate for progress toward achieving U.S. national and military goals. These presentations will promote support for friendly forces among local populations and external groups (including in some cases the enemy's own population). Also, these presentations will reduce the effectiveness of enemy PSYOP directed at friendly forces and supporting civilian groups. FM 12-50 explains in detail the employment of U.S. Army bands.

PSYOP SUPPORT OF SOF OPERATIONS

The following paragraphs address the levels of and the PSYOP capabilities in support of other SOF.

Army Special Operations Forces

ARSOF include PSYOP, CA, Special Forces (SF), Army special operations aviation (ARSOA), and rangers. FM 100-25 describes the roles, missions, organizations, and capabilities of these forces.

Special Operations

SOF are specially organized, trained, and equipped military forces that conduct SO to achieve military, political, economic, or psychological goals. These forces may perform their missions in hostile, denied, or politically sensitive areas. They conduct SO independently or in support of general purpose forces in peacetime, conflict, and war. Politico-military considerations frequently shape SO requiring clandestine or low-visibility techniques and oversight at the national level. SO differ from conventional

operations in their degree of risk, operational techniques, and mode of employment. They are often conducted independent from friendly support and dependent upon operational intelligence and indigenous assets.

Public law (10 USC 167) states that SO activities include-

- Direct action (DA).
- Special reconnaissance (SR).
- Unconventional warfare (UW).
- FID.
- CA.
- PSYOP.
- Counterterrorism (CT).
- Humanitarian assistance (HA).
- Theater search and rescue (SAR).
- Other activities specified by the NCA.

SOF have specific organization, training, and equipment to conduct SO activities. They provide a versatile military capability to defend U.S. national interests. An integral part of the total defense posture of the United States, SOF are a strategic instrument of national policy.

CONFLICT

- Indirect application of national power
- Ambiguous political and politico-military objectives
- Subjective results
- Interagency and combined efforts in which the military does not have the lead
- Discriminate engagement to preclude conventional war
- Emphasis on nonmilitary aspects that dominate military operations

WAR

- Direct application of military force
- Clear military objectives
- Measurable results
- Emphasis on warfighting

Figure 3-1. Differences in focus.

SO Principles

In tactical combat operations, SOF follow the basic operational tenets and imperatives of the general purpose forces. This doctrine explains how Army forces plan and conduct major operations, battles, and engagements with other Services and allied forces. They do not address military strategy or the formulation of strategic guidance. They do, however, favor a strategy that quickly and decisively attains the military strategic goals in war.

At the tactical level, SO share many of the characteristics of light infantry combined arms operations. The fundamentals of doctrine, however, focus primarily on fighting in a conventional war. The traditional goal of military power in war has been to generate maximum combat power at the decisive time and place to defeat hostile military forces. The traditional dynamics of military power are inappropriate in a conflict environment in which—

- Nonmilitary aspects of the situation dominate military operations.
- No clearly defined opponent or battlefield exists.

In either environment, the focus of military operations is different, and the contemporary dynamics of military power are subtler. (See Figure 3-1.) Commanders must influence, not dominate, their operational environment to create favorable politico-military conditions for achieving specific national

security goals. In such environments, SOF commanders must adapt the basic tenets to account for SO politico-military implications. They must learn to apply military power indirectly through a foreign government's military and paramilitary forces or other political groups. They may also apply military power directly through the surgical use of combat power.

Implementation of SO Imperatives

PSYOP commanders plan and employ PSYOP based on SO imperatives. (See Figure 3-2.) These imperatives give focus to SO doctrine and forces in the operational continuum.

Understand the Operational Environment

The target audience's environment determines the execution of PSYOP. The design of appeal and action programs must make sense and its call to action attainable. Also, portions of target audiences may lie outside the boundaries of the AO.

Recognize Political Implications

PSYOP planners must consider the immediate and long-term political changes their programs may generate. Depending on the forces' actions and media coverage of these actions, SO may generate a target audience's resentment or appreciation.

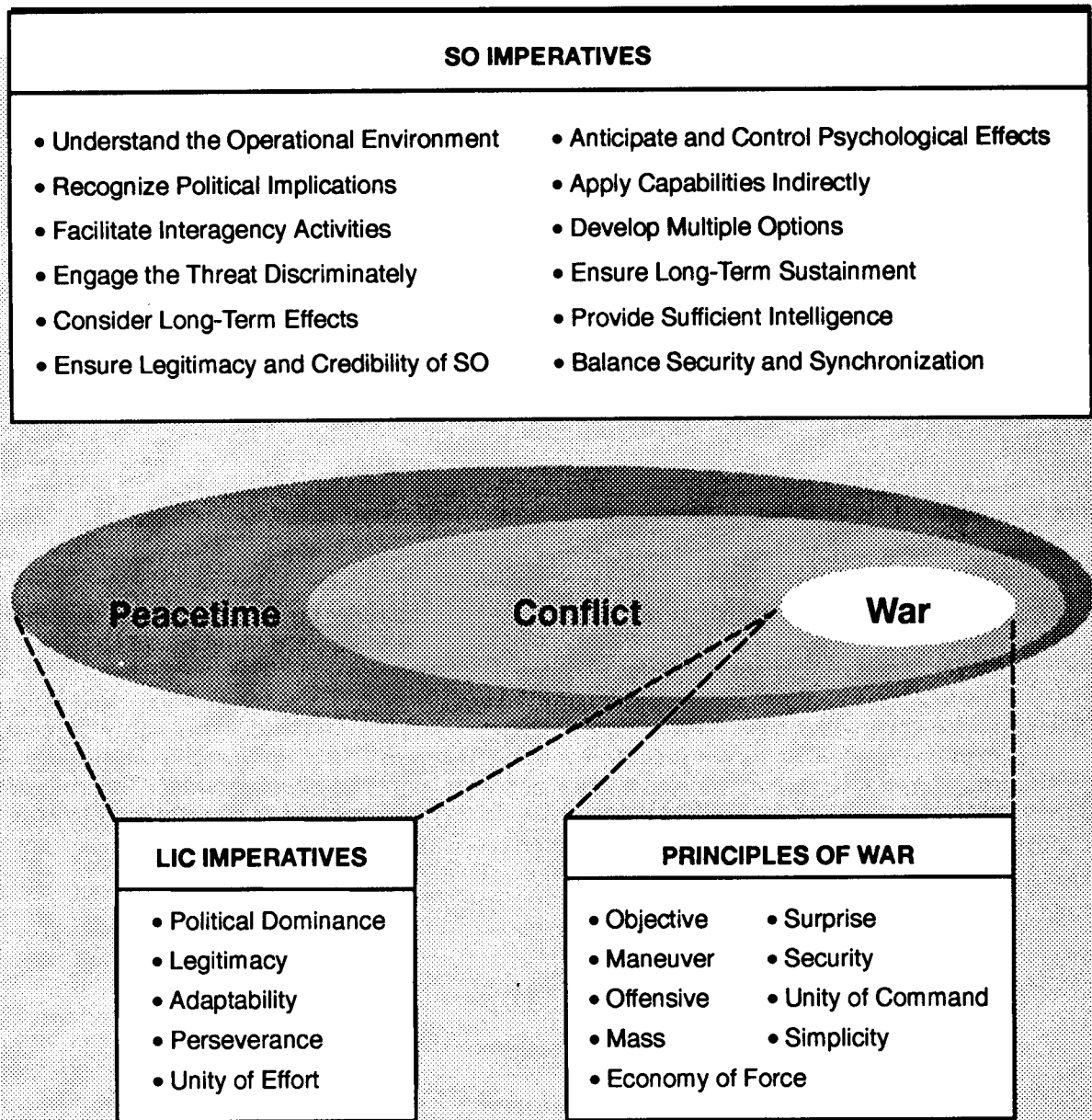

Figure 3-2. Imperatives for all operational environments.

Facilitate Interagency Activities

One way to project foreign policy is through military PSYOP. These operations require coordination with the actions of other Services and government agencies. The PSYOP staff officer performs this coordination as described in Appendix E.

Engage the Threat Discriminately

The use of PSYOP depends on the target audience’s accessibility and ability to perform

the desired psychological action. PSYOP analysts also consider the appeal’s effects on unintended target audiences.

Consider Long-Term Effects

PSYOP planners must not only consider the immediate psychological effects of a PSYOP appeal but also its effects on future generations. The SOF image created during FID programs, contingency operations, and exercises may be an enduring one.

Ensure Legitimacy and Credibility of SO

PSYOP appeals and actions must clearly state U.S. policy. They must also emphasize the advantage—economic, social, and political—the target will gain by cooperation. In military operations, PSYOP must reflect a credible picture of actions taken and projected.

Anticipate and Control Psychological Effects

The world watches U.S. military operations with great interest. A temporary tactical advantage may not justify a strategic, international setback. Commanders and their PSYOP advisors must consider the psychological impact of every military operation on local, regional, and international audiences.

Apply Capabilities Indirectly

Whenever possible, PSYOP commanders must use in-country intelligence, production, and dissemination to suit actions and appeals to the target audience. The message must clearly emphasize the need for target audience participation in solving problems.

Develop Multiple Options

In their programs, PSYOP planners must use every possible dissemination means. They also leave options open for target audience response as U.S. policy guidelines allow.

Ensure Long-Term Sustainment

PSYOP planners must develop and field programs that reflect U.S. strategic goals. These policies support U.S. goals of regulated international commerce, access to resources, and protection of U.S. citizens and their partners.

Provide Intelligence

PSYOP specialists provide their superiors target audience intelligence needed to estimate accurately the results of psychological and military operations.

Balance Security and Synchronization

PSYOP must execute appeal and action programs that coincide with and amplify the effects of other military operations. This coordination provides maximum psychological effect while preserving operational Security.

Support to SOF Primary Missions

SOF area part of modern warfare. They may support conventional military operations, or they may function alone. PSYOP may support the following SOF missions: UW, FID, DA SR, and CT.

Unconventional Warfare

See the glossary for a definition of UW. The PSYOP objectives in a UW operation normally include-

- Creating popular support for the insurgent movement.
- Promoting reforms the insurgent organization will establish after the hostile government's overthrow.
- Developing support of the populace to allow the insurgents to avoid detection and move freely and to aid in recruiting for the insurgent political and intelligence infrastructure.
- Promoting the recruitment of others into the resistance movement.
- Informing the international community of the goodwill and intent of the United States and the insurgents.
- Discrediting the existing government and its programs.
- Countering hostile propaganda.
- Gaining support of the indigenous populace for U.S. support and/or presence.
- Maintaining motivation among the insurgents.
- Passing information or instructions to the resistance organization or its subordinate elements.

- Providing a “link” between the resistance organization and the “outside” world.
- Training indigenous or other U.S. assets to perform the PSYOP goals of the UW operation.

Resistance leaders plan and conduct PSYOP that support the resistance movement’s needs and goals. The SF team and its PSYOP advisors must convince the resistance movement’s leaders to support U.S. national PSYOP goals in the region. They must also persuade the leadership to support themes and messages developed at the supporting operational base. In addition, the SF team must convince the leaders to obtain popular support for the resistance movement.

The presence of SF teams in a particular country serves as tangible evidence of U.S. interest and support. Through daily face-to-face meetings with local leaders, SF soldiers strengthen mutual respect, confidence, and trust. They gain valuable insight into the problems of the resistance movement. They also improve rapport by sharing the same living and fighting conditions. These shared associations and mutual respect promote a favorable climate to conduct UW operations.

Deployed SF teams work closely with the insurgents. They train, advise, and help selected resistance movement personnel in target analysis, media selection, and PSYOP product development. Conventional PSYOP techniques are equally applicable during UW operations. However, PSYOP personnel must be aware that UW employment considerations are different from conventional PSYOP use because of the operational environment. PSYOP’ four major UW targets are-

- The uncommitted.
- Hostile sympathizers.
- Hostile military forces.
- Resistance sympathizers.

The uncommitted. The uncommitted are members of the general populace who are neutral. They may fear the organization’s

aims or are doubtful of its success. PSYOP support must therefore stress that the resistance organization share the political, economic, and social goals of the populace. PSYOP support must also stress that the United States and its allies, in supporting the resistance movement, support these same goals and that the resistance movement will be successful.

Hostile sympathizers. Hostile sympathizers include willing collaborators, persons under duress, and passive, hostile sympathizers. PSYOP’ goal toward this target audience is to instill doubt and fear within its members. To achieve this goal, PSYOP personnel often work with positive political action programs. Such programs normally try to identify and discredit hostile collaborators or to weaken their belief in the hostile power. Punitive action against collaborators, however, may result in hostile reprisals and a loss of civilian support for the resistance movement. Hostile overreaction, though, can serve to build popular support for the resistance movement.

Hostile military forces. Hostile military forces may include the government forces, an occupying power, or other forces helping the hostile government. They may or may not be of the same nationality as the populace. PSYOP focus on the hostile soldier’s frustrations. They try to lower his morale, reduce his effectiveness, and create feelings of inadequacy, insecurity, and fear. These feelings increase the opponent’s susceptibility to PSYOP. They make him more vulnerable to appeals to surrender, malingering, show disaffection, or desert. PSYOP directed at this target audience seek to make the members feel isolated, improperly supported, doubtful of the outcome of the struggle, distrustful of each other, and doubtful of the morality of their cause.

Resistance sympathizers. Resistance sympathizers are sympathetic to the resistance movement’s goals but are not active members of it. PSYOP directed at this target audience stress appeals for active support or passive cooperation. Inherent in the appeals is enforcement of a rigid personal code of

conduct by resistance members. Each resistance leader must respect the people and their sensitivities, especially their culture, customs, and needs. The resistance movement's words and deeds must assure the people it will protect them from the hostile power. The resistance movement itself must serve as an instrument of political, social, and economic progress.

The United States can undertake long-term operations to support selected resistance movements. The organizations the United States most often supports are those that oppose foreign powers hostile to vital U.S. interests. However, direct U.S. military involvement is rare and subject to legal and policy constraints. Indirect support from friendly territory is the norm. PSYOP assets usually operate with SF during the seven phases of the development of a U. S.-sponsored resistance movement:

- Phase I, Psychological Preparation.
- Phase II, Initial Contact.
- Phase III, Infiltration.
- Phase IV, Organization.
- Phase V, Buildup.
- Phase VI, Combat Employment.
- Phase VII, Linkup and Demobilization.

Phase I, Psychological Preparation. In this phase, PSYOP prepare the inhabitants of the area to receive U.S. forces.

PSYOP planning occurs at the highest level of the government preparing to support the resistance movement. Participants include citizens-in-exile, key in-country sympathizers, and other popular, respected, and influential people.

Phase II, Initial Contact. In this phase, U.S. nonmilitary agencies make sure the populace is willing to sponsor the resistance movement. The SF teams go into isolation to receive extensive briefings and to conduct studies.

PSYOP emphasis is on support for the planned resistance operations. With the

help of indigenous assets, PSYOP elements develop PSYOP plans for the joint special operations area (JSOA). PSYOP elements develop themes, symbols, and action programs that support resistance operations from infiltration to demobilization.

In this phase, PSYOP prepare the inhabitants of the area to receive U.S. forces.

PSYOP elements explain the PSYOP plan for each AO to SF and area specialist teams. They also provide PSYOP training to SF teams and indigenous assets.

Phase III, Infiltration. In this phase, the SF team begins the area assessment. Based on the results, a PSYOP program through face-to-face communication begins. Operational elements establish rapport with resistance leaders.

PSYOP elements support U.S. and the resistance movement contacts by publicizing tangible evidence of sponsor support. Sponsor support normally includes weapons, ammunition, medical supplies, and money.

Should the team be prematurely discovered or go down in another country before making the target drop zone, PSYOP specialists can assist in informational damage control.

Phase IV, Organization. In this phase, the SF team establishes rapport with resistance movement's leaders. The resistance movement is operational. Training begins, and small-scale combat operations occur.

PSYOP promote the resistance movement's expansion and development. PSYOP use themes to help the resistance organization win the populace's support. Additionally, PSYOP programs can support damage control and assist the development of a sound infrastructure. Such programs contribute to the overall attainment of the resistance movement's goals.

Resistance movement leaders help formulate psychological goals. They try not to take any action that contradicts or interferes with reaching those goals.

PSYOP elements begin motivational programs targeting the resistance movement. These programs focus on the country's history and the hostile power's history and goals.

PSYOP programs cover the resistance movement's political, economic, and social goals; the resistance movement cadre's ideological indoctrination; the practical impact of tactical operations on the population; and the significance of and need for the resistance members' proper personal conduct with the populace.

Phase V, Buildup. In this phase, small-scale combat operations increase local support and attract recruits for the resistance movement. SF teams increase their activities to establish rapport, promote cooperation and unified action, provide tangible proof of support, and motivate the resistance members.

PSYOP focus on the resistance movement's full expansion and development. Successful and robust programs increase recruitment for the resistance movement. They also enhance the resistance leadership's legitimacy and effectiveness. PSYOP programs encourage and win general civilian support for the resistance movement. They emphasize the rules of engagement (ROE) and identify targets whose destruction would impact adversely on the civilian populace. They continue to stress and assure the success of the resistance movement and allied operations. They impress on the resistance organization's leaders that producing favorable reactions among the populace is vital. Such programs must stress proper individual and official conduct toward the populace. They must also point out the need for stringent disciplinary action against offenders.

Phase VI, Combat Employment. In this phase, PSYOP exploit successful small-scale combat operations to attract more recruits. The resistance organization is at full strength, and full combat operations are about to begin. The hostile power actively engages in reprisals and counter guerrilla

operations. Because of hostile propaganda, disruption of daily life, and destruction of property, the populace may question the resistance movement's cause.

Note: PSYOP are offensive. They do not defensively react to the hostile power's reprisals or actions to discredit the resistance force.

This phase continues until the linkup with general purpose forces or the end of hostilities.

PSYOP support and exploit the resistance movement's combat capability. PSYOP elements increase motivational programs. They focus on themes and symbols for specific target audiences. For the general populace, the themes and symbols are nationalism and the support of the resistance movement. The themes and symbols for the resistance movement are success over the hostile power and inevitability of complete victory. The focus on the hostile force is the inevitability of its defeat by the resistance force and its demise everywhere.

Essentially, PSYOP support in this phase is comparable to support to U.S. general purpose forces.

Phase VII, Linkup and Demobilization. In this phase, general purpose forces move into range of the JSOA Linkup operations are imminent. The senior PSYOP commander at the general purpose force headquarters plans PSYOP to support the linkup and demobilization of the resistance movement's armed elements. The PSYOP commander prepares and coordinates linkup plans with the PSYOP personnel supporting the resistance movement. Because of their extreme sensitivity and importance, demobilization plans must begin in the early phases of operations and be continuous.

When the resistance movement's armed elements are no longer needed, higher headquarters orders their disposition, including demobilization. The practical problems of nationalization (for example, political, economic, social, ethnic, racial, religious, and military) come to the surface.

PSYOP products and actions support linkup and demobilization. During linkup, PSYOP in the JSOA prepare the populace to cooperate fully with the general purpose tactical forces. PSYOP elements urge the populace to remain in place ("stay put" policy) and not to hinder operations. They brief the resistance organization's leaders on the importance of cooperating with the tactical force commanders and accepting the general purpose force leadership. PSYOP elements psychologically prepare the resistance organization to assume whatever roles the legal government wants it to play. These roles include but are not limited to their incorporation into the national army, paramilitary organizations, national police, or demobilization. Commanders and staff officers inform the troops of the importance of proper individual and unit conduct. During demobilization, PSYOP programs explain the demobilization process. They promote the insurgents' orderly transition to peaceful civilian life. Their primary aim is to prevent the formation of quasi-military or political groups opposing the recognized government. Loyalty to the legitimate government is the major concern.

Foreign Internal Defense

See the glossary for a definition of FID. It is a primary mission of SF, CA, and PSYOP battalions. FID operations occur in all environments (remote, urban, or rural) during peace and war to promote national and regional stability. Both the government and the insurgents use PSYOP to mobilize the people. The PSYOP target may be the HN's armed forces and populace, as well as opponent or foreign groups.

PSYOP are an integral part of all counter-insurgency (COIN) activities. They meet the specific requirements for each area and operation. Commanders must consider the psychological impact of military and non-military COAs. At times, they may need to sacrifice short-range tactical advantages to preserve long-range psychological goals. PSYOP emphasize assessing the potential threat to the HN and the United States. In addition to providing advisors and

instructors to the HN, PSYOP personnel can help prepare the AO for U.S. forces.

PSYOP support the achievement of national goals by specific target audiences. In FID, specific PSYOP goals exist for the following target groups:

- *Insurgents.* To create dissension, disorganization, low morale, subversion, and defection within insurgent forces. (No single way exists to influence deliberately foreign targets. Planning stems from the viewpoint of those affected by a conflict. The HN's government needs national programs designed to win insurgents over to its side.)
- *Civilian populace.* To gain, preserve, and strengthen civilian support for the HN's government and its COIN programs.
- *Military forces.* To strengthen military support, with emphasis on building and maintaining the morale of these forces. (The loyalty, discipline, and motivation of the forces are critical factors in combatting an insurgency.)
- *Neutral elements.* To gain the support of uncommitted foreign groups inside and outside the HN. (Effective ways of gaining support are to reveal the subversive activities and to bring international pressure to bear on any external hostile power sponsoring the insurgency.)
- *External hostile powers.* To convince them the insurgency will fail.

PSYOP can assist a FID mission by reaching some or all of the following goals:

- Improving popular support for the HN government.
- Discrediting the insurgent forces to neutral groups and the insurgents themselves.
- Projecting a favorable image of the HN government and the United States.
- Supporting defector programs.
- Providing close and continuous PSYOP support to CMO.
- Establishing HN command support of positive populace control and protection from insurgent activities.

- Informing the international community of U.S. and HN intent and goodwill.
- Passing instructions to the HN populace.
- Developing HN PSYOP capabilities.

Direct Action

See the glossary for a definition of DA. It is a primary SF and ranger mission. ARSOA has a capability to perform limited DA.

PSYOP support of DA operations depends on the situation, mission, and type of forces involved. PSYOP support of DA missions needs to be closely coordinated and linked to U.S. public diplomacy and command information programs. While U.S. public law prevents the use of PSYOP on its own forces or populace, nothing prevents the United States from using PSYOP resources to tell foreign target audiences what the U.S. is telling its civilians. Common PSYOP objectives in a DA operation are-

- Explaining the purpose of the operation to counter the enemy and to ensure that friendly, neutral, and hostile audiences know what has occurred and why.
- Establishing control of noncombatants, neutrals, and other groups in the operational area. These actions help reduce casualties and prevent interference with friendly operations.
- Reducing interference in the DA operation by hostile forces and nations,
- Exploiting target audiences that might not be otherwise accessible. Exploitation includes demoralizing potential adversaries with the results of the operation.
- Assessing the psychological impact of the operation.
- Reducing the adverse effects of mission failure.
- Capitalizing on DA mission success in strategic PSYOP campaigns.
- Supporting DA missions in support of contingency operations.

Special Reconnaissance

See the glossary for a definition of SR. SR is a primary SF mission. PSYOP support SR by—

- Assessing the psychological impact of the operation to include the impact on compromised clandestine or covert operations.
- Limiting or negating the effects of compromise.
- Conducting cover and deception operations.
- Providing personnel to help in area assessments.

Counterterrorism

See the glossary for a definition of CT. It is a primary SF mission. The following elements limit SOF involvement in CT:

- HN responsibilities.
- Lead agency authority-Department of Justice (DOJ) and DOS.
- Legal and political restrictions.
- Appropriate DOD directives.

When directed by the NCA or the appropriate unified commander, SF units support CT missions that include-

- Hostage rescue.
- Recovery of sensitive material from terrorist organizations.
- Attack on the terrorist infrastructure.

Identifying targets for a CT mission can be difficult because of the low profile of most terrorist organizations. PSYOP must integrate with other security operations to target the forces employing terrorism. The aim is to place the terrorist forces on the psychological defensive. To do so, PSYOP personnel analyze the terrorists' goals and use PSYOP programs to frustrate those goals. PSYOP support by—

- Countering the adverse effects of a terrorist act.
- Providing personnel to assist in area assessments.

- Assessing the psychological impact of the operation to include the impact of the compromise of clandestine or covert operations.
- Limiting or negating the effects of compromise.
- Lessening popular support for the terrorist cause.
- Publicizing incentives to the local people to inform on terrorist groups.
- Persuading the terrorists they cannot achieve their goals through terrorist activities. Persuading them they are at personal risk and responsible governments will not negotiate.
- Countering terrorist propaganda.
- Conducting deception operations to mask CT forces intent.

PSYOP support of SOF Collateral Activities

In addition to primary missions, PSYOP personnel support collateral activities. These activities include HA, counterdrug (CD), and security assistance (SA). (See FM 100-25.)

Humanitarian Assistance

HA is any military act or operation of a humanitarian nature. These activities include disaster relief, noncombatant evacuation, and support to resettlement of displaced civilians. PSYOP support in HA, like most SO, requires significant interagency coordination.

Counterdrug

CD operations are measures taken to disrupt, interdict, and destroy illicit drug activities. The levels of violence by the drug infrastructure dictate the increased use of military and paramilitary forces in CD operations. A 1981 amendment to the Posse Comitatus Act (18 U.S. Code 1385) authorizes DOD help in drug interdiction and eradication. The primary PSYOP role in CD operations is to support U.S. and HN efforts abroad.

International drug trafficking contributes to international instability. Illegal drug traffickers provide certain insurgent and terrorist groups lucrative revenue sources and access to worldwide smuggling networks. In return, these groups provide security and protection to illegal drug traffickers.

The Bureau of International Narcotics Matters and the Drug Enforcement Administration are lead CD agencies within a HN.

PSYOP advisors may help CD staffs in planning, organizing, and conducting large-scale, long-term CD operations. When authorized, PSYOP advisors may accompany CD forces on actual operations. National Security Directive 18 further addresses the CD effort.

Security Assistance

SA is a group of programs under which the United States helps foreign governments and international organizations. The purpose of SA is to enhance U.S. and mutual security. Authority for SA comes from the Foreign Assistance Act, the Arms Export Control Act, and other U.S. statutes. The U.S. Government provides SA to eligible foreign countries and international organizations that further U.S. national security goals. The assistance includes defense articles and services such as training. PSYOP in SA support SF mobile training teams (MTTs) and other forms of mobile training. Public law prohibits personnel providing SA services from performing combatant duties. For a detailed discussion of SA programs, see DOD Directive 5105-38-M, AR 12-1. and AR 12-15.

PSYOP support of Other SO Activities

The grouping of SO activities as primary missions and collateral activities focuses on what SOF can do. Primary missions are those for specifically trained, organized, and equipped SOF. Collateral activities are those SOF can perform based on capabilities

developed for the primary missions. In some cases, the primary focus is on why SOF conduct SO. The physical result of SO may be secondary to some main purpose. (See FM 100-25.) Demonstrations and show-of-force operations are examples of such activities.

Demonstrations and show-of-force operations are overt demonstrations of national intention or resolve. Their purpose is to influence another government or political group to respect U.S. interests or to enforce

international law. These operations may involve—

- Forward deployment of military forces.
- Combined training exercises.
- Introduction or buildup of military forces in a region.

The purpose of demonstrations and show-of-force operations is not to deceive the target audience. These operations may meet with a hostile response, so they must be able to counter such a response.

PSYOP SUPPORT OF CONVENTIONAL OPERATIONS

Conventional operations can occur throughout the operational continuum in a variety of situations. U.S. national military strategy has changed. The Army's primary mission is now one of power projection. A smaller U.S. Army with global responsibilities will train to fight wars and conflicts. It will support our allies in nation assistance and peacetime engagement as well. PSYOP forces, like the rest of SOF, are regionally oriented and can be called upon to provide area expertise to commanders. Properly planned and executed PSYOP can enhance the success of conventional operations in warfighting situations or in situations for operations short of war (See Figure 3-3). For information on low intensity conflict (LIC), see Joint Pub 3-07 and FM 100-20/AFP 3-20.

Operations

The international security environment has undergone recent changes. The current success in the curtailment of Soviet expansionism marks not only the transition from U.S.-Soviet bipolarity to a new world order in which there is a reduced influence from the republics of the former Soviet Union but also a shift to increased instabilities in the world. Army forces will be used with forces of other Services, often with other agencies and other nations and under the control of

a joint headquarters. Military operations are planned, resourced, and executed to achieve strategic goals. As the global environment changes, Army doctrine will continue to evolve. The reunification of Germany, the dissolution of the Warsaw Pact and the Soviet Union, and the implementation of the conventional Armed Forces in Europe (CFE) Treaty have combined to require this evolution. New centers of power are taking shape. Powers are no longer defined solely in military form. They also involve economic, political, religious, and technological considerations. Unacceptable conditions of poverty, violence, ecological ruin, and economic deprivation continue to affect the world order. Also, conflicts in and among developing nations are no longer shaped primarily by their involvement in superpower competition. The results of operations Desert Shield and Desert Storm favorably influenced the acceptance of PSYOP by the senior military and political leadership as a legitimate combat multiplier.

Emerging technologies have allowed unprecedented chances to see the battlefield before conducting offensive operations. However, the basic tenets of the AirLand Battle (initiative, agility, depth, and synchronization) continue as fundamental tenets. PSYOP support conventional operations in all four tenets.

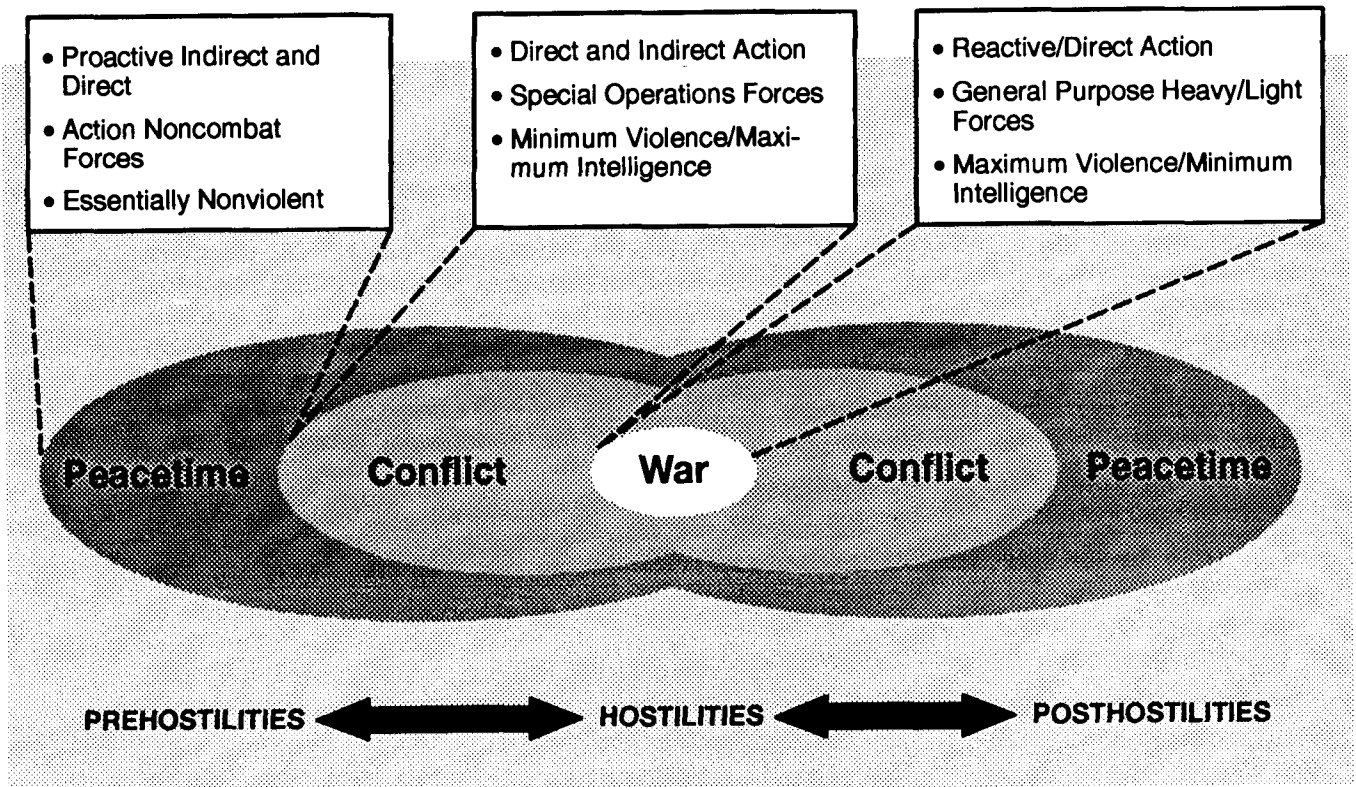

Figure 3-3. Operational continuum.

Initiative

Initiative means setting or changing the terms of battle by action. PSYOP help to seize the initiative by attacking the opponent's will to fight and influencing him to behave favorably to the friendly commander. Such initiatives take place—

- Before hostilities.
- Just before hostilities.
- During hostilities.
- After hostilities.

Before hostilities. PSYOP can persuade target audiences that engaging in war or warlike activities may not be in their interest. Activities and actions that may take place could include media broadcasts, national and allied political pronouncements and conferences, and economic sanctions. Military activities include show-of-force posturing and troop alerts.

Just before hostilities. PSYOP prepare foreign target audiences (hostile, friendly, and neutral) for the introduction of U.S. forces

into a potential AO. These programs support U.S. strategic actions by reducing the public's interference with the U.S. deployment.

During hostilities. PSYOP support the tactical commanders' operations through surprise, deception support, and other actions that undermine the opponent's morale and will to continue to fight.

After hostilities. PSYOP include actions needed to create a favorable impression of U.S. efforts. Such actions include publicizing U.S. troop withdrawal plans and supporting the public's reorientation and education about the new emerging political environment.

Agility

Agility is the friendly forces' ability to act faster than the opponent. PSYOP can disrupt the opponent's coordination, cohesion, and reaction time, giving the friendly commander a decisive advantage. PSYOP forces can task organize to respond quickly to changing environments.

Depth

Depth is the extension of operations in space, time, and resources. It is not limited, however, to a geographic definition. PSYOP can attack the opponent throughout the battlefield. PSYOP assets can add depth to a commander's forces by—

- Supporting cover and deception operations and SO.
- Promoting dissidence and defection within opponent ranks.
- Countering opponent subversion and propaganda.
- Sustaining the morale of allies and the people in opponent-occupied territories.

Synchronization

Synchronization is the arrangement of battlefield actions to produce maximum relative combat power at the decisive point. Full integration of PSYOP into operational planning and their execution enhance the effectiveness of military operations. Coordinating a PSYOP program's start or end to coincide with appropriate military operations enhances the success of both activities.

Offensive Operations

During offensive operations, PSYOP units provide close, continuous support to the supported unit and its maneuver elements. Because the support depends on the specific offensive operation, PSYOP considerations are a part of all operational planning. PSYOP personnel, therefore, must work closely with the supported unit. Planners consider PSYOP's ability to degrade the effectiveness of the opponent's second-echelon unit support. PSYOP support role varies. METT-T influence PSYOP requirements to support the offensive.

The Army conducts offensive operations by performing four interrelated functions. PSYOP must be integrated into and support each function to ensure their maximum impact during execution.

PSYOP units prepare for the operation by assessing intelligence and information, planning, and moving forces or capabilities needed for the operation. PSYOP planners must be included in these initial planning stages. They must have access to current intelligence and information available on opposing forces and other target audiences. They must have the time to tailor prepacked programs for the intended target audience.

PSYOP units use all available means required to set the conditions for the best use of Army capabilities to achieve decisive results. PSYOP are often considered one of those "other means available." The war-fighting commander must know his PSYOP forces' capabilities.

PSYOP units conduct the actions to achieve the desired result. This function occurs during dissemination of PSYOP products and during PSYOP actions.

PSYOP units prepare for further follow-on or new operations. The PSYOP commander must weigh available capabilities and plan further missions. He must be judicious in assigning PSYOP missions to PSYOP forces. He must match his force's capabilities and talent against the possible array of supported command offensive operations. In some situations, for example, he may have all his printing assets print safe conduct passes. In another contingency, he may direct only half of his printing assets to the safe conduct program and the other half to a command information program handout. The most effective use of PSYOP forces is a goal for all PSYOP commanders and planners.

During offensive operations, the tactical support mission of PSYOP units is to provide close, continuous support to the supported unit and its maneuver elements. PSYOP personnel coordinate closely with the supported unit's operations officer to make sure BPA become an integral part of the operation. Planners consider the ability of PSYOP to degrade the effectiveness of the

opponent's follow-on unit support in all offensive planning.

The type of offensive operation influences the type of PSYOP support. However, PSYOP can—

- Exploit the effects of friendly nuclear fires.
- Exploit the effects of the offensive in conventional operations.
- Increase or decrease the psychological impact of enemy biological or chemical operations.
- Help subordinate units exploit targets of opportunity.
- Help higher and adjacent units by influencing the opponent's actions outside the boundaries of those units.
- Help exploit the lethal fires of tactical fire support elements in the AO.
- Increase the effectiveness of heavy ordnance and massed fires.

Offensive operations on a more open, less structured battlefield present an environment in which successful operations depend more on initiative and the pursuit of a clearly defined intent to defeat the opponent's capabilities than on key terrain objectives as addressed in previous Army doctrine. The shift in emphasis from terrain to opponent objectives offers PSYOP greater windows of opportunity. The traditional orientation on close, deep, and rear operations as different operations has given way to one extended battle, with the synchronized use of combat power contributing directly to the objective.

PSYOP commanders must make sure their assigned PSYOP forces can carry out PSYOP programs in the warfighting environment of offensive operations. PSYOP commanders must maintain combat-ready PSYOP forces to support the principle of power projection. PSYOP forces must be ready to mobilize on short notice for contingency offensive operations. Forward operational detachments (FODs), while supporting scaled-down, forward-deployed units, must be ready to support out-of-region contingencies. The Army must be versatile, deployable,

lethal, and expandable. PSYOP commanders must keep abreast of these characteristics to support offensive operations.

Defensive Operations

PSYOP units supporting tactical units in the defense continue to maintain a PSYOP offensive. While the supported units usually remain in defensive positions to gain time, keep ground, or deny the opponent access, PSYOP maintain an offensive momentum. In addition, PSYOP personnel conduct research and develop, refine, and test products, thereby promoting PSYOP success.

A difficult aspect of defensive operations is retrograde operations. Commanders who use PSYOP must put extra emphasis in coordination and execution. If PSYOP assets are in proper positions, the supported commander should have uninterrupted PSYOP support. During a delaying action, tactical PSYOP elements can support operations security (OPSEC) using information that supports the tactical operation. Tactical PSYOP elements can also support a withdrawal or retirement by supporting tactical deception operations and publicizing civilian support measures.

To support the commander in the defense, PSYOP units can—

- Prepare to resume the offense.
- Discourage an opposing offensive.
- Support forces delaying the advance of opposing units.
- Support the planning and conduct of counterattacks.
- Support forces delaying an opposing advance using tactical deception operations to support OPSEC.
- Support rear area protection operations.
- Gain the willing, active support of the people.
- Strengthen friendly leaders and weaken hostile leaders.
- Breed uncertainty in opposing troops.

- Influence opponent strategy and tactics.
- Arouse public opinion in favor of friendly forces and foment political and economic pressures against opponent operations.
- Stimulate support of opposition elements against the opponent, particularly those within opposing territory.
- Lower the morale and efficiency of opposing military forces and civilians by encouraging disaffection among potentially dissident elements.
- Advise on the psychological implications of planned and executed COAs.
- Identify and locate target audiences, identify conditions and pinpoint vulnerabilities, establish new goals, and obtain pertinent information to guide PSYOP exploitation.
- Study opponent PSYOP efforts to identify psychological weaknesses, both friendly and opponent.
- Coordinate with other PSYOP units to consolidate assets, if warranted.
- Reconstitute as the situation dictates.
- Continue to brief the supported commander on the PSYOP program, personnel, and equipment.

PSYOP SUPPORT OF LOW INTENSITY CONFLICT

LIC is an environment in which a politico-military confrontation occurs between contending states or groups. This confrontation is below conventional war and above the routine, peaceful competition among states. LIC frequently involves protracted struggles of competing principles and ideologies. LIC ranges from subversion to the use of armed force. It is waged by a combination of means using political, economic, informational, and military instruments. It is in the use of the informational instrument where PSYOP, in concert with other U.S. Government information programs, plays an important role. (For further information, see Joint Pub 3-07 and FM 100-20/AFP 3-20.) The LIC environment appears to be the most likely threat to our national interests through the 1990s. Increased emphasis will be on operations in support of our allies. The indirect use of Army capabilities will dominate the LIC environment. In general, LIC environments occur in underdeveloped Third World countries. These countries are typically beset with instabilities associated with lack of developmental growth or periods of frustration in achieving it.

Strategic PSYOP support long-range goals. Tactical PSYOP companies or PSYOP battalions usually support the committed U.S. forces. PSYOP coordination with the affected

country's U.S. Ambassador and his country team is essential. It is also important for the PSYOP commander or planner to coordinate with other government agencies and the country team while operating in a LIC environment. One aspect of the current world situation is the prudent use of U.S. assistance to Third World countries not yet faced with an overt threat to their stability. This assistance must be designed to help maintain or foster a stable environment in which they can mature politically, socially, and economically. This preventive strategy seeks to use U.S. assistance to prevent the onset of a conflict. Should a conflict occur, however, it will help resolve the situation. PSYOP are one of several military activities short of combat operations that may contribute to this preventive strategy. PSYOP may support these activities if approved by the country's U.S. Ambassador. U.S. Army involvement in these activities includes personnel from the Active Component (AC) and the Reserve Components (RC), either U.S. Army Reserve or Army National Guard. These activities include-

- Security assistance.
- Combat command cooperative programs.
- Combined training exercises.
- Port visits.
- Intelligence support.

- Subject matter expert (SME) exchanges.
- Conferences and seminars.
- Civil actions.
- Engineer support.
- Construction assistance.
- Medical exercises.
- CMO.
- Infrastructure development.

LIC Imperatives

The following paragraphs address how PSYOP support the LIC imperatives.

Primacy of the Political

Instrument

In the LIC environment, political goals drive military decisions at every level, from the strategic to the tactical. PSYOP support this imperative by helping commanders and their staffs understand the culture and customs of the HN. PSYOP personnel coordinate with CA staff officers to make sure pertinent information is current and accurate.

Unity of Effort

PSYOP commanders and planners must realize they cannot operate in a vacuum. They may answer to civilian agency heads. Interagency integration allows for effective actions to occur.

Adaptability

PSYOP personnel must adapt to methods and structures and help develop new ones suited for each mission. PSYOP regional expertise is a useful facet of the imperative.

Legitimacy

Legitimacy is willing acceptance by the people of their government's right to govern. It derives from the perception their government is genuine and effective. PSYOP programs can help develop positive perceptions.

Perseverance

Perseverance is the persistent pursuit of national goals. LICs are by their nature protracted conflicts. They often have no clear beginning or end. PSYOP programs help develop long-term goals, not just short-term goals.

Restricted Use of Force

The ROE are usually more restrictive, more detailed, and more subject to political scrutiny than are the rules of war. PSYOP commanders and planners must abide by the ROE. By doing so, they reinforce legitimacy.

LIC Categories

The following paragraphs discuss the four categories of LIC: insurgency and counterinsurgency, combatting terrorism, peacekeeping, and peacetime contingencies. PSYOP commanders and planners use initiative and imagination to support these categories. LIC operations support the economy-of-force principle of war. They focus on long-range goals with minimal commitment of major U.S. forces in a combat role.

Support to Insurgency and Counterinsurgency

The aim of all insurgencies and counterinsurgencies is political, not military. Therefore, political leadership is of paramount importance, with the military playing a supporting role. The more the civilian leader or military commander understands the insurgents' motivations and goals, the more successful he will be in anticipating their behavior. PSYOP personnel can assist in this understanding by developing or updating SPAs.

Combatting Terrorism

Terrorism may erode public support for a stated policy or program. It may cause the loss of credibility or a diminished capacity for the United States to influence international events. The U.S. Government usually establishes a lead agency when an act of terrorism occurs. The agency may be the DOS,

DOJ, DOD, or Department of Transportation (DOT). A U.S. armed forces response may be necessary to protect U.S. citizens and security interests. The deterrence of acts of terrorism through active and passive measures is antiterrorism. Employing forces to address terrorist situations directly is counterterrorism.

There are several reasons for terrorism's immense psychological impact. Terrorism does not follow the "law and customs" of war as conceived by most nations. It presents military forces with a type of warfare difficult to combat by conventional means. Terrorists may strike anywhere without warning. Terrorism can be an ever-present threat, yet provide no visible target to defend or strike against. Terrorism allows a militarily weak force to attack stronger opponents. Terrorist supporters may exploit the open society of democracies to spread propaganda. Conversely, terrorism can have a negative psychological impact that the opponents of terrorism can exploit. Terror—

- Can discredit its users by making terrorists appear as criminals or perpetrators of atrocities.
- Can alienate the people from the terrorist cause. It can make them more readily seek the protection of the government opposing terrorism.

Terror can also achieve some psychological goals. Some of these include—

- Demoralizing an opposing force, a political infrastructure, or the civilian populace.
- Building morale by providing a symbol of resistance.
- Providing the chance to distribute propaganda by exploiting the attention gained from the terrorist act.

Combatting terrorism consists of actions taken to counter the terrorist threat. PSYOP can be effective in countering terrorism. They must, however, be a part of long-term national policy directed at the nations and

organizations using terrorism. PSYOP personnel develop PSYOP countermeasures to prevent or reduce terrorism's effectiveness. The countermeasures focus on two distinct target audiences:

- The entire target audience of the terrorist action.
- The terrorists themselves and their active supporters.

To be effective in combatting terrorism, PSYOP must—

- Support a national policy goal to defeat the nation or organization employing terror.
- Integrate with other security operations, including intelligence, police, military, and paramilitary measures.
- Target the forces using terrorism and place them on the psychological defensive. PSYOP cannot simply react to individual acts of terrorism because reaction would give the terrorists the psychological initiative.
- Analyze the terrorists' goals and use PSYOP to frustrate these goals. PSYOP personnel must determine the ultimate audience and counter the effects of the terror.

PSYOP' role is critical in both the analysis of the threat of terrorism and in the activities directed against terrorism. Since terrorists direct their terror at the will of the populace, PSYOP must maintain friendly popular support while attacking the terrorists and their supporters. To lessen or help eliminate a terrorist threat, the terrorist organization's infrastructure must be identified, its goals exposed, and its support neutralized. These tasks are hard because the clandestine nature of terrorist organizations hampers intelligence collection efforts. PSYOP countermeasures often apply to antiterrorism and CT. (Antiterrorism actions are defensive measures to reduce the vulnerability of individuals and property to terrorism. CT actions are offensive measures to prevent, deter, and respond to terrorism.) Some

specific goals of PSYOP countermeasures to terrorism are to—

- Maintain the support of friendly populaces and nations during protracted terrorism counteraction campaigns.
- Convince the populace that terrorists are against the people.
- Inform the populace of the true goals of the terrorists and create a desire to use government systems to protect lives and property.
- Inform the international community of the terrorists' acts to dissuade other nations from supporting the terrorists.
- Expose the nature of the terrorist infrastructure to foreign audiences to discredit it in the people's eyes and limit the terrorists' relative freedom of movement.
- Exploit terrorist attacks on noncombatants to gain sympathy within the foreign country and elsewhere. PSYOP campaigns conducted in foreign countries require careful coordination with other U.S. Government agencies concerned with the dissemination of public information in the U.S. and abroad.
- Help the HN distribute information on its nation-building programs to gain popular support in countering terrorism.
- Advance the isolation of the terrorist organization from its popular support base.
- Gain indigenous support for friendly CT forces and actions.
- Gain information about the terrorist organization by convincing the people to give information to friendly intelligence agencies.
- Undermine the terrorists' morale and confidence in their leadership.
- Deglamorize terrorists, thus reducing the impact of terrorists' acts.
- Take a tactical role in CT. PSYOP teams can accompany forces to help convince terrorists to surrender or release hostages.
- Cause members of the terrorist organization to defect and surrender.
- Publicize, when security permits, successful CT actions that show friendly forces defeating terrorists.
- Gain support for sometimes inconvenient security measures needed to combat terrorism.
- Counter propaganda conducted by terrorists, their supporting organizations and states, and their sympathizers.

Peacekeeping

Military peacekeeping operations support diplomatic efforts to maintain peace in areas of potential or actual conflict. The single, most important requirement of a peacekeeping operation is the consent of all parties to the dispute. This consent represents an explicit agreement for the introduction of a neutral third party. The United Nations (UN) is the most frequent sponsor of peacekeeping operations. PSYOP forces can capably support peacekeeping operations.

Army participation in peacekeeping operations may be multinational or unilateral. A peacekeeping mission may present ambiguous situations requiring the forces to deal with extreme tension and violence. Tension and violence may come in the form of terrorism, sabotage, and minor military conflicts from known and unknown belligerents. Peacekeeping requires the belligerents' consent to interpose an uncommitted, non-aligned third party between two or more hostile parties. The primary PSYOP goal in peacekeeping missions is to help gain and maintain peace by influencing the opinions, emotions, attitudes, and behaviors of the belligerents and the HN populace.

The extent of PSYOP involvement in peacekeeping operations depends upon several key factors. Politically delicate and highly sensitive peacekeeping situations demand careful planning and preparation of all committed forces. The extent of the overall effort and the strength of the peacekeeping force dictate the amount of PSYOP support needed. Including PSYOP personnel and

equipment gives the peacekeeping force commander an additional capability for completing his mission. The PSYOP expertise can help maintain the belligerents' consent and the peacekeeping force's neutrality. A combination of various PSYOP programs can help peacekeeping efforts. The complete impartiality of all participants in peacekeeping operations is crucial to success. Achieving and maintaining impartiality in the belligerents' eyes, however, is a problem for many peacekeeping operations, considering the polarity and interdependence of the world today. Key roles of PSYOP personnel in peacekeeping operations are to promote information and education programs, assist in peacekeeping training for other nations, and provide advisors to allied and U.S. agencies.

Information and Education Programs. To lend credence to the impartiality of the peacekeeping force and to maintain that credibility, the peacekeeping force commander relies heavily on public information services. The power of public information services in creating a favorable response, both inside and outside the AO, is critical. The release of false information can adversely influence the course of a dispute: intelligent and diplomatic use of factual information can contribute to success. Potential and real crises can be averted when using the truth to counter rumors, disinformation, and misrepresentation of facts.

The peacekeeping force commander may determine there is a need to inform and educate HN civilians and belligerents about the peacekeeping force. Information programs must emphasize that the peacekeeping force's purpose is to maintain the cease-fire until a peaceful settlement can be reached. The programs should also explain that a peacekeeping force is an apolitical and impartial entity whose presence is temporary. The programs must convince the belligerents and the HN populace that the force's presence will benefit them. The peacekeeping force commander has the prerogative in requesting support for information and education programs.

PSYOP personnel and equipment can provide the needed support. Mobile printing presses can produce a variety of printed material to support information and education programs. PSYOP radio, motion picture, video, and TV broadcasts can complement the printed material. In addition, PSYOP personnel can make sure the information and education program is within the cultural context of the target audience. For example, in many Arab countries where the credibility of women is low, PSYOP personnel would know not to have a female promote the program.

PSYOP personnel can also plan an information and education program because of their knowledge of the political, economic, sociological, psychological, military, and communications aspects of the HN. This knowledge can help develop area-oriented information programs for the peacekeeping force. These programs could enhance operations and ensure their applicability to the region, its populace, cultures, religions, and mores. In peacekeeping, the emphasis is on the soldier at the point of contact and his leadership. They act as an immediate buffer to hold crisis situations in check and avoid an escalation to open conflict. Therefore, the peacekeeping force's success depends on the regional and area training of its personnel. PSYOP personnel can provide valuable input to such training.

Peacekeeping Training for Other Nations. The United States has an excellent capability to help train peacekeeping forces from other nations. PSYOP personnel can play a key part in these training programs because of their extensive regional expertise. For example, the United States trained and equipped the six-nation Caribbean peacekeeping force for duty in Grenada. PSYOP aspects of foreign nation peacekeeping training can help in educating the force to maintain its neutrality and the HN's security. In such a situation (as in Grenada), the peacekeeping force could also provide stability and security while the HN builds up or restructures its ability to defend itself. Of course, if a surrogate force or the belligerents opposing the HN do not consent to

the presence of peacekeeping forces, the situation reverts to peacemaking instead of peacekeeping. Some specific items that require PSYOP emphasis in foreign peacekeeping training include—

- Advising U.S. trainers on the culture, mores, and idiosyncrasies of both the HN and the peacekeeping forces.
- Making sure training is within the HN's culture.
- Training the peacekeeping force to operate PSYOP equipment, such as the mobile audiovisual unit (AN MSQ-85B), portable printing presses, and loudspeakers.
- Training the peacekeeping force to operate fixed facilities, such as radio and TV stations, movie theaters, and printing plants.
- Providing other PSYOP help as required by the force commander.
- Advisors to allied peacekeeping efforts. When U.S. forces are not a part of the peacekeeping effort, allied forces may still request U.S. PSYOP help. In response to these allied requests, PSYOP personnel could provide equipment, advice, or training. PSYOP equipment that could be furnished includes mobile printing presses for the production of leaflets, posters, magazines, and pamphlets; radio and TV broadcast equipment; and any other audiovisual equipment, such as loudspeakers, movie projectors, and tape recorders. PSYOP personnel could also act as advisors and furnish technical assistance to their allies who may be a part of a multinational peacekeeping force. Also, PSYOP elements could train the allied peacekeeping forces. The involvement of PSYOP elements must be discreet and must not compromise the impartiality of the allied peacekeeping force.

Advisors to Other U.S. Agencies. When U.S. military assets are not a part of the peacekeeping force, PSYOP advisors can provide expertise and help to other U.S. civilian and military departments and

international agencies. Normally, effective PSYOP activities in any peacekeeping effort require the sanctions of DOS. The delineation of responsibilities, functions, and inter-agency relationships of the PSYOP assets is vital to the peacekeeping effort.

Occasionally, USIA USAID, DOD, or other U.S. agencies with assets in the HN require some form of PSYOP support. PSYOP personnel may advise the country team, furnish PSYOP studies, or provide specific PSYOP equipment and personnel.

In all cases, participants must maintain close, continuous coordination with DOS. The dynamics of negotiation, mediation, and conciliation in peacekeeping processes are akin to PSYOP methods or procedures. PSYOP can be very valuable in stressing these themes to help resolve the conflict. Although PSYOP assets and expertise normally function as part of a PSYOP program, they can operate as separate activities.

Peacetime Contingencies

Peacetime contingency operations occur in crisis avoidance or crisis management situations requiring the use of military forces to enhance or support diplomatic initiatives. Contingencies focus on specific problems usually requiring rapid, decisive solutions. Management of these operations is usually at the highest level of government. These operations are normally short in duration. Contingencies always have a strong psychological impact on the attitudes and behavior of domestic and foreign audiences. The following factors influence the nature and scope of contingencies:

- Duration of operation.
- Mobility and flexibility of available forces.
- Available intelligence.
- Overflight or country basing rights.
- Available refueling assets.
- Logistics support.
- Communications support.
- PSYOP programs.
- CA programs.

- Public affairs.
- Security requirements.
- Operational constraints.

A single Service, two or more Services, or other governmental agencies can conduct contingency operations. PSYOP can support contingency operations. When PSYOP are not a part of the early planning stages of contingency operations, the full potential of the activities will not be harvested. The senior PSYOP commander must coordinate with other U.S. Government agencies to achieve the synergy required to bring to bear the maximum psychological impact. Contingency operations include the following activities:

- Disaster relief.
- Demonstrations and show-of-force operations.
- Noncombatant evacuation operations (NEO).
- Recovery.
- Attacks and raids.
- Freedom of navigation and protection of shipping.
- Operations to restore order.
- Security assistance surges.
- Military support to counterdrug operations.

Disaster relief. This activity has high visibility and can have a great psychological impact. PSYOP programs can exploit these humanitarian operations by “advertising” where the relief is coming from. Advertising the support will help project a favorable image of the United States to the international community.

Demonstrations and show-of-force operations. The NCA order these activities. They are well-recognized PSYOP activities. They lend credibility to U.S. promises and commitments, increase U.S. regional influence, and show U.S. resolve. Aircraft and ship visits, combined training exercises,

forward deployment of military forces, or the buildup of military forces in a region are examples of these operations. Demonstrations and show-of-force operations must be part of a PSYOP program at the highest echelon of U.S. Government. Various adverse psychological effects may outweigh the positive influences. The power expressed by these activities may affect the international gold market, international relations, and international stock markets. The projected power may also decrease international support for U.S. policy.

Noncombatant evacuation operations (NEO). NEO activities relocate threatened civilian noncombatants from locations in a foreign HN. DOS directs the conduct of NEO activities. The timely execution of such activities may prevent hostile elements from taking U.S. citizens as hostages or protect them from the ravages of a natural disaster. The psychological impact of NEO is enormous. These activities demonstrate to the world community U.S. resolve to protect its citizens.

Recovery. These activities are sophisticated operations requiring detailed planning. They may include the recovery of U.S. or friendly foreign nationals, or the location, identification, and recovery of sensitive equipment critical to U.S. security. Successful recovery activities have a positive impact on the morale and cohesiveness of U.S. forces. In planning these activities, BPSs, special PSYOP studies (SPSs), and SPAS on the recovery area may be helpful. PSYOP can support deception efforts before and during the actual recovery try. Also, a PSYOP program may be developed to further the effects of a successful operation or to counter the negative effects of a failed mission.

Attacks and raids. These activities differ from other peacetime contingency operations (PCO) in their overt use of force. The highest level of U.S. authority must consider these activities. Psychologically, the impact is high.

Freedom of navigation and protection of shipping. These activities show U.S. resolve to recognize the sovereign rights based in international law of freedom of navigation and shipping. Again, the highest level of U.S. authority must consider the psychological impact on the world community.

Operations to restore order. These activities usually take place after a request from proper national authorities in a foreign state. Such activities may also take place to protect U.S. citizens. These activities may result in follow-on peacekeeping operations as described earlier. They may be initiated to achieve or maintain peace without the consent of the belligerents.

Security assistance surges. These activities occur when a friendly or allied nation faces a threat of imminent harm. The United States may speed up the shipments of weapons, equipment, or supplies to the concerned nation. PSYOP programs may help to ease tensions in the concerned nation during these activities.

Military support to counterdrug operations. These activities are undertaken to reduce or eliminate the supply of illicit substances entering the United States and to reduce the demand for those drugs within the U.S. armed forces. PSYOP programs, when directed, support national drug control strategies.

Chapter 4

Force Structure

The current organization of the AC PSYOP group results from the lessons learned during operations Just Cause, Promote Liberty, Desert Shield, Desert Storm, and Provide Comfort. Future PSYOP support to the mission requirements of the unified combatant command CINCs will be IAW this organization and its functions. This chapter outlines the current PSYOP organization and functions resulting from these experiences.

MISSION

The AC PSYOP group plans and conducts PSYOP activities authorized and implemented worldwide in support of all non-mobilization contingencies during crises and open hostilities short of declared war. It also develops, coordinates, and executes

peacetime PSYOP activities. In addition, should war be declared, the AC PSYOP group assists in the planning and execution of strategic and operational PSYOP for the unified command CINCs.

GROUP HEADQUARTERS AND HEADQUARTERS COMPANY

The PSYOP group's command group and staff (headquarters), in a deployed mode, becomes the senior Army PSYOP headquarters within a combatant command and assumes OPCON of all Army PSYOP forces. (See Figure 4- 1.) When required, a properly augmented PSYOP group headquarters forms the combatant command's headquarters joint psychological operations task group (JPOTG) and assumes OPCON of all PSYOP forces assigned to the combatant

command. In addition to assuming all OPCON-implied functions, the deployed PSYOP group serves as the staff PSYOP planning element for the unified command CINC by establishing a JPOTG or other organization when directed. The headquarters acts as the focal point for the coordination of interagency PSYOP actions supporting U.S. national goals. Should mission requirements dictate, the PSYOP group command section may be realigned

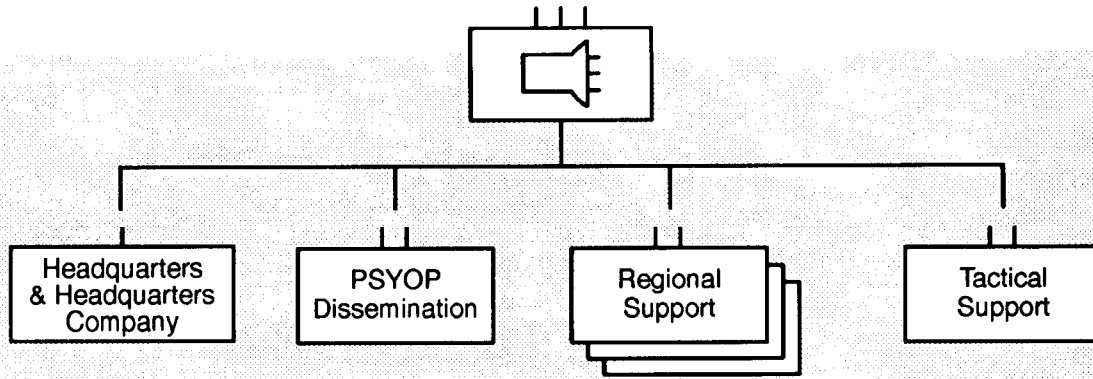

Figure 4-1. PSYOP group (AC).

to support the unified command CINC and one major combatant command subordinate headquarters (for example, JTF), simultaneously. The headquarters company normally collocates with the PSYOP group headquarters and its commander serves as the headquarters commandant.

The group headquarters consists of the command group, the special staff group, and the group staff. (See Figure 4-2.)

Command Group

Members of the command group include the-

- Commander.
- Deputy Commander.
- Executive Officer.
- Command Sergeant Major.

Commander

The commander serves as the PSYOP special staff officer to the unified command CINC and becomes the focal point for all inter-agency PSYOP activities conducted in the combatant command. (The commander also performs functions IAW paragraph 1-3, FM 101-5; and paragraph 3-15, change 1, Joint Pub O-2.)

Deputy Commander

Should realignment of the headquarters be required to support a second combatant echelon above corps (EAC) command (for example, TA), the deputy commander as-

sumes command of this second command. (The deputy commander also performs functions IAW paragraph 1-6, FM 101-5; and paragraph 3-15, change 1, Joint Pub 0-2.)

Executive Officer

The executive officer determines the sufficiency of the headquarters deployment package, to include making provisions for manning a second combatant EAC command. He coordinates, reviews, and supervises the presentation of required briefings of PSYOP concepts, plans, and products to senior flag officers, ambassadors, and high-level foreign national officials. (The executive officer also performs functions IAW paragraph 2-7, FM 101-5.)

Command Sergeant Major

The command sergeant major performs functions IAW paragraph 3-27, FM 101-5.

Special Staff Group

Members of the special staff group include the-

- Communications-Electronics (CE) Officer.
- Staff Judge Advocate (SJA).
- Resource Management Officer (RMO).
- Unit Ministry.
- Maintenance Officer.
- Plans, Programs, and Force Development (PPFD) Officer.

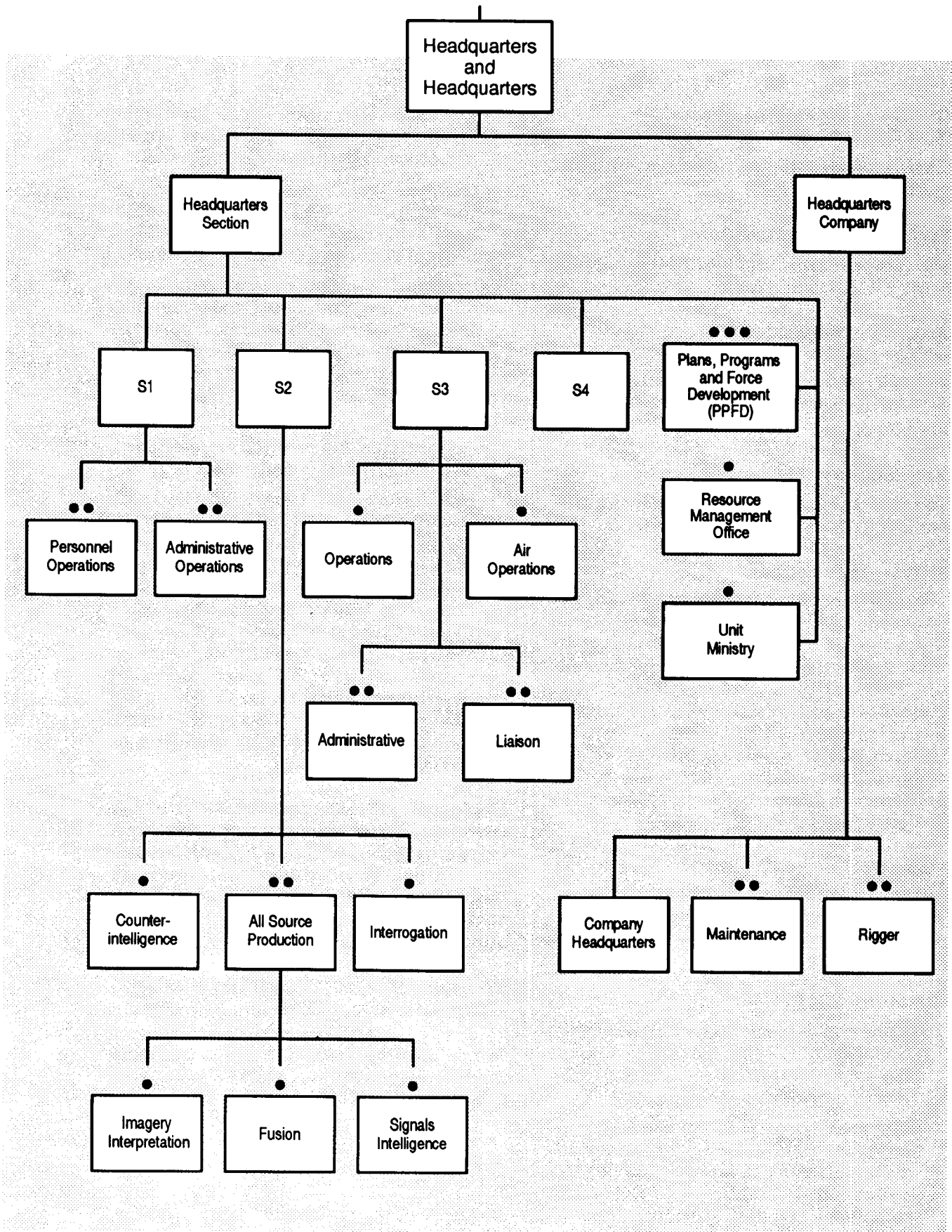

Figure 4-2. HHC, PSYOP group (AC).

Communications-Electronics (CE) Officer

The CE Officer performs functions IAW paragraph 3-28, FM 101-5.

Staff Judge Advocate (SJA)

The SJA performs functions IAW paragraph 3-44, FM 101-5 and AR 27-1.

Resource Management Officer (RMO)

The RMO performs functions IAW paragraph 3-16 (Assistant Chief of Staff, Comptroller), FM 101-5.

Unit Ministry

The unit chaplain performs functions IAW paragraph 3-24 (Chaplain), FM 101-5.

Maintenance Officer

The maintenance officer manages the deployment of maintenance contact teams supporting AC PSYOP units deployed worldwide, across the entire operational continuum. He also manages all PSYOP group and subordinate unit maintenance activities to include prescribed load list (PLL), The Army Maintenance Management System, vehicle maintenance and repair, and readiness. (The maintenance officer also performs functions IAW paragraph 2-7, FM 101-5.)

Plans, Programs, and Force Development (PPFD) Officer

The PPFD officer is responsible for planning, deployment readiness, programs, and force development.

Planning. The PPFD—

- Plans and coordinates peacetime PSYOP activities directed by the JCS to support the NCA, all unified command CINCs, and other government agencies.
- IAW with Annex D to the JSCP, coordinates the production of PSYOP appendixes and supporting plans to all OPLANs and concept plans (CONPLANs) of unified commands and their service commands, subordinate unified commands, special operations command (SOCs), and JTFs.

- Assists subordinate PSYOP units develop PSYOP supporting plans for all OPLANs and CONPLANs, as required.
- Deploys a contingency planning cell to the NCA, JCS, and unified command CINCs during crises, open hostilities short of declared war, and declared war.
- Develops, coordinates, and updates required memorandums of understanding (MOUs) and memorandums of instruction (MOIs) to ensure PSYOP personnel and equipment are properly supported and used by all supported headquarters and agencies.
- Coordinates AC and RC time-phased force deployment data development.
- IAW Annex D to the JSCP, the DOD PSYOP Master Plan, and the appropriate mission letter, establishes and maintains liaison with the JCS; Headquarters, Department of the Army; USSOCOM; supported unified and specified command CINCs; subordinate unified commands; theater service component commands; JTFs; SOCs; and applicable government agencies. In addition, the PPFD uses established requisite communications channels for resolution of PSYOP-related issues.

Deployment Readiness. The PPFD plans, coordinates, and manages worldwide exercise participation for the PSYOP group headquarters and its subordinate units to ensure they maintain proper deployment readiness levels. The PPFD also validates the PSYOP support developed in the planning process.

Programs. The PPFD facilitates the integration of AC and RC PSYOP unit planning.

Force Development. The PPFD performs force development functions IAW paragraph 3-6, Organization, FM 101-5.

Group Staff

Members of the group staff include the S1, S2, S3, and S4. They perform functions IAW paragraph 2-7, FM 101-5.

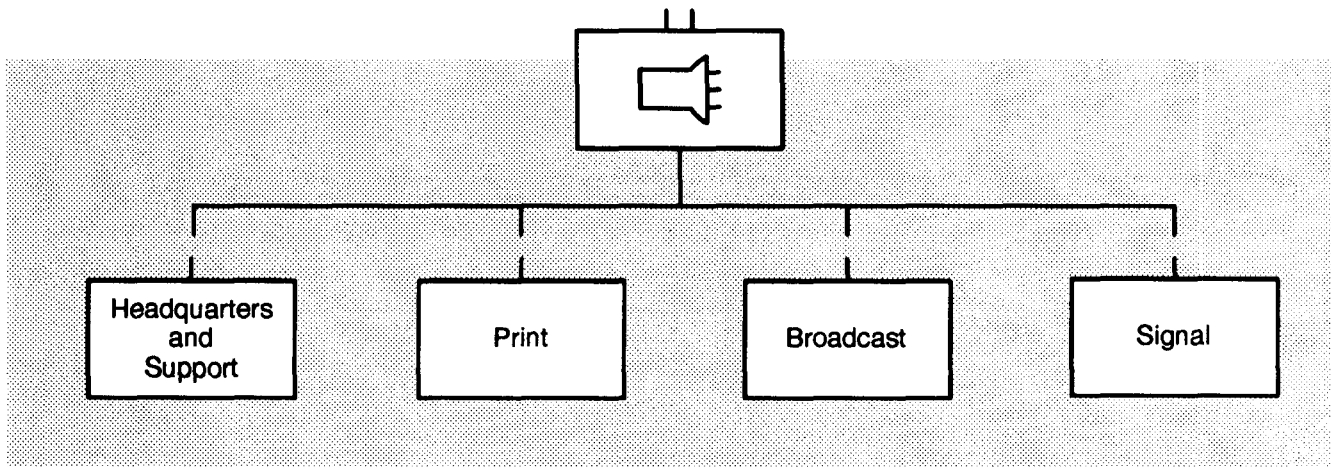

Figure 4-3. PSYOP dissemination battalion (AC and RC).

PSYOP DISSEMINATION BATTALION

The PSYOP dissemination battalion provides audiovisual and printed materials production, signal support, and media broadcast capabilities to support the PSYOP group, PSYOP battalion(s), and/or tactical support company(s). (See Figure 4-3.) It provides

support across the operational continuum as well as in response to peacetime PSYOP requirements levied by the JCS or other government agencies. This battalion must be able to support at least two separate theaters simultaneously.

PSYOP DISSEMINATION BATTALION HEADQUARTERS

The PSYOP dissemination battalion headquarters and support company (HSC) (see Figure 4-4) would not normally deploy as an entire unit. It does, however, deploy elements to provide command and control for deployed print, media, and signal teams and maintenance support to deployed print, media production, and broadcast equipment.

The dissemination battalion staff performs the following functions

- Manages and supervises—
 - Routine battalion-level administrative and logistics functions.
 - Multiple and simultaneous PSYOP print, audiovisual, and signal support taskings.
 - OPSEC.
 - Deployment readiness of personnel.
 - Large and sophisticated PSYOP print and media production/broadcast equipment.
 - Security clearance coordination and management.
 - Supervises the worldwide deployment of elements providing command and control of PSYOP dissemination battalion teams.

PRINT COMPANY

All print and print-related personnel and equipment authorized within the AC PSYOP group organization are assigned to the print company of the PSYOP dissemination

battalion. (See Figure 4-5.) The company provides a print support slice to the deployed PSYOP battalion(s) and, if appropriate, to deployed tactical support company(s).

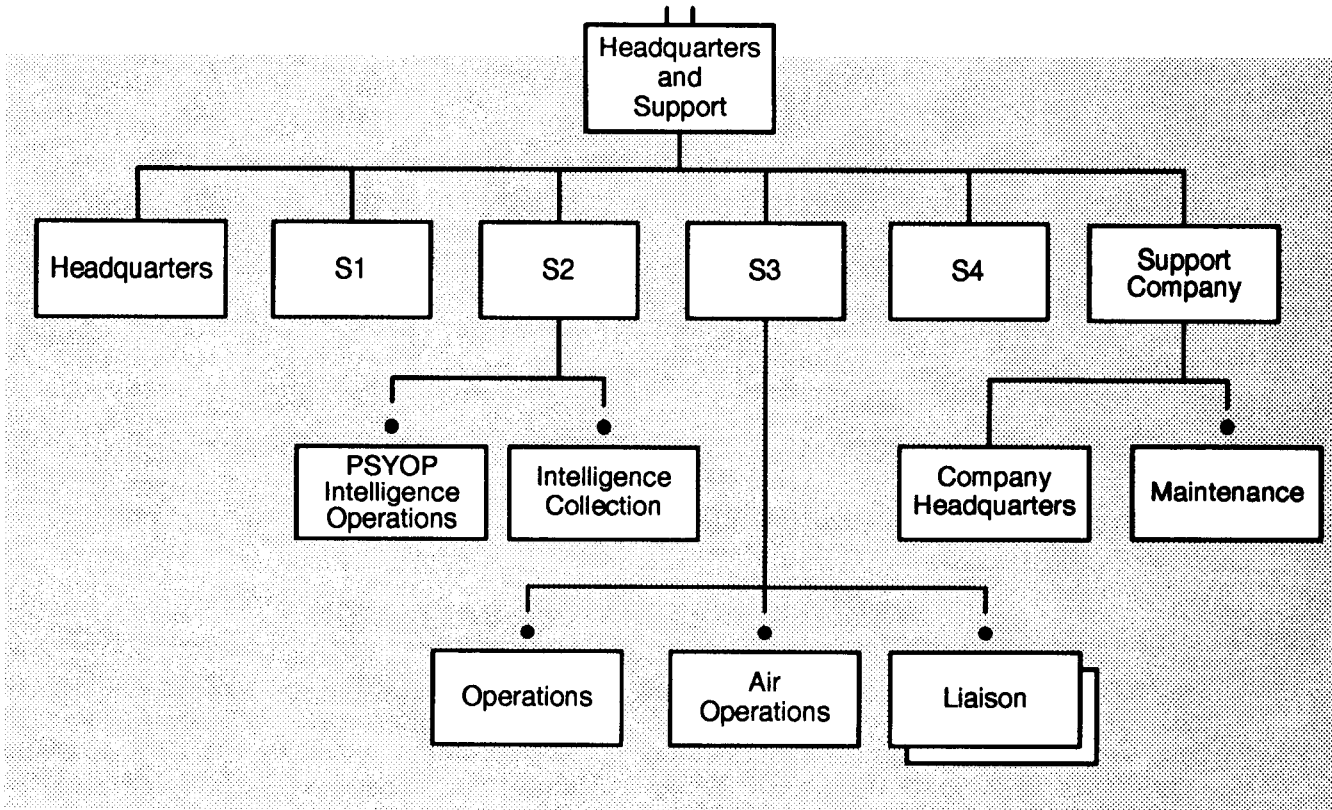

Figure 4-4. HSC, PSYOP dissemination battalion (AC).

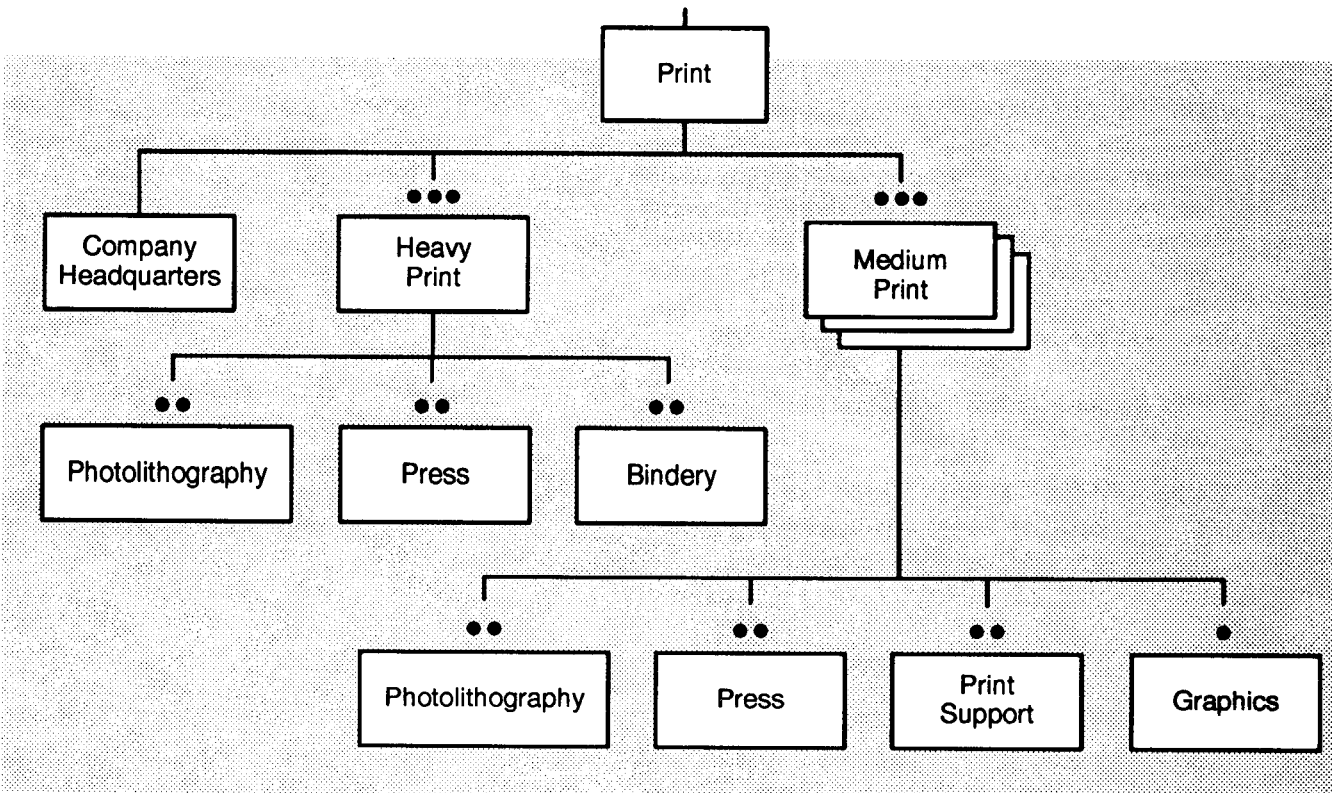

Figure 4-5. Print company, PSYOP dissemination battalion (AC).

Support is provided across the operational continuum as well as in response to peacetime PSYOP requirements established by the JCS or other government agencies.

The print company staff performs the following functions:

- Produces, in high volume, printed products (leaflets, newspapers, magazines, books, posters) at the heavy print facility to be transported to supported commands for dissemination.

- Deploy—anywhere in the world—up to three light and/or three modular print systems with operators

or

Deploys anywhere in the world (including airborne deployments) up to three print platoons capable of operating local national or HN printing equipment

or

Any combination thereof, simultaneously.

BROADCAST COMPANY

The broadcast company of the PSYOP dissemination battalion provides media production and broadcast support to the PSYOP group, PSYOP battalion(s), and/or tactical support company(s). (See Figure 4-6.) Support is provided across the operational continuum as well as in response

to peacetime PSYOP requirements established by the JCS or other government agencies. The broadcast company provides the personnel needed for routine staff functions for the fixed media production center and deployed media production and broadcast teams.

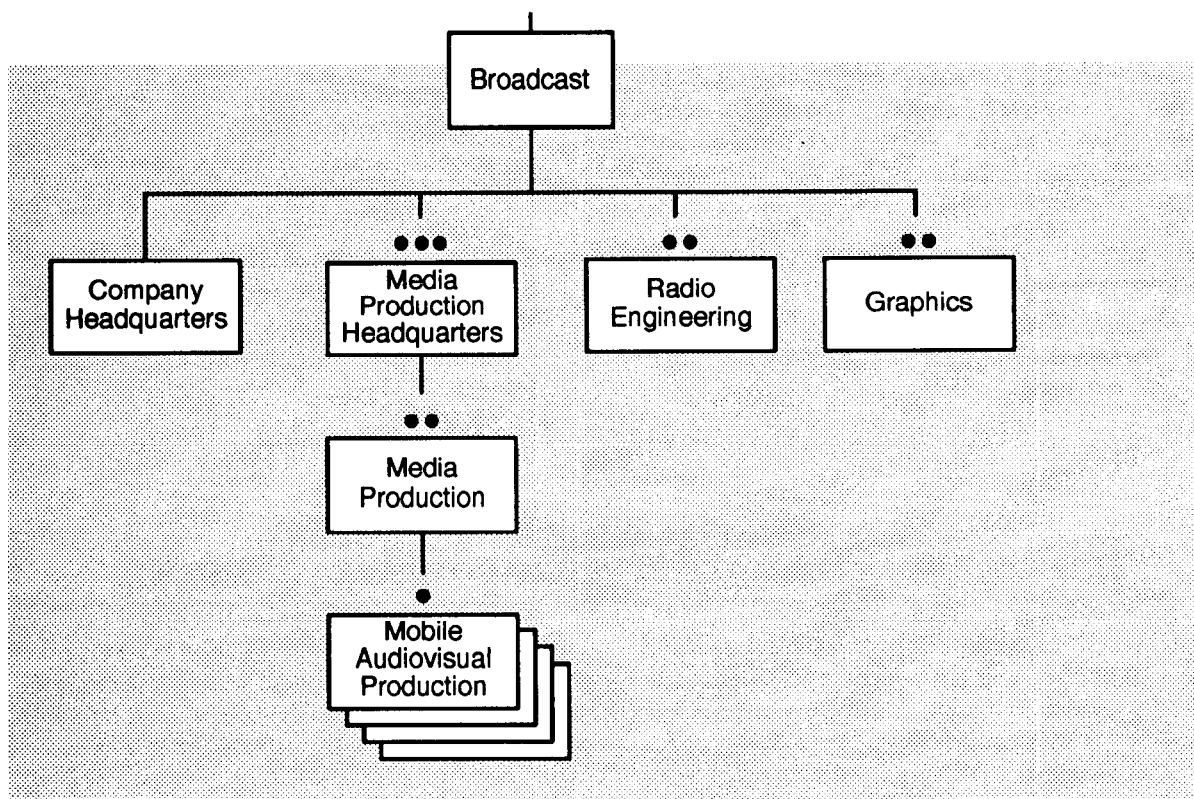

Broadcast company, PSYOP dissemination battalion (AC).

The broadcast company staff performs the following functions:

- Provides quality video and audio PSYOP products, in color formats, for worldwide dissemination to deployed media production and broadcast personnel.
- Simultaneously deploys worldwide (including airborne deployments) up to four video camera teams with mobile editing equipment capable of producing high quality audio and video products.
- Deploys worldwide (including airborne deployments) media production and broadcast personnel that can operate

local national or HN media production and broadcast facilities.

- Deploys media production and broadcast personnel to support airborne and/or seaborne broadcast platforms.
- Deploys a mobile TV broadcast facility, including power generation equipment with operators, to support operational PSYOP requirements worldwide.
- Deploys 5-kw, 10-kw, and 50-kw radio stations, including its supporting antenna and power generation equipment with operators, to support operational PSYOP requirements worldwide.

SIGNAL COMPANY

The signal company provides required communications support to the PSYOP group, PSYOP battalion(s), and/or tactical support company(s). (See Figure 4-7.) Support is provided across the operational continuum as well in response to peacetime PSYOP requirements established by the JCS or other government agencies. The signal company provides the personnel needed for routine staff functions. for the deployed signal support teams.

The signal company staff performs the following functions:

- Provides unit-level signal support to the deployed elements of the PSYOP group, as required.

- Simultaneously deploys (including airborne deployments) up to five signal support teams worldwide.
- Deploys (including airborne deployments) signal support personnel and communications equipment to provide required communications capabilities, on a continuous basis, to deployed AC PSYOP elements.
- Establishes and maintains CONUS and outside the continental United States (OCONUS) data, voice, and secure facsimile links to expedite and enhance PSYOP.

PSYOP REGIONAL SUPPORT BATTALION AND HEADQUARTERS AND SUPPORT COMPANY (AC AND RC)

The PSYOP regional support battalion (RSB) (see Figures 4-8 and 4-9) consists of a headquarters element, a support company, and one or more regional support companies (RSCs). Unless command and control (C²) elements from a PSYOP group deploy to the theater, the RSB is the senior Army PSYOP

headquarters in a combatant command (see PSYOP group, Figure 4- 1). In addition to providing PSYOP to conventional and special operations across the operational continuum, the RSB responds to peacetime PSYOP requirements established by the JCS or other government agencies. The RSB must

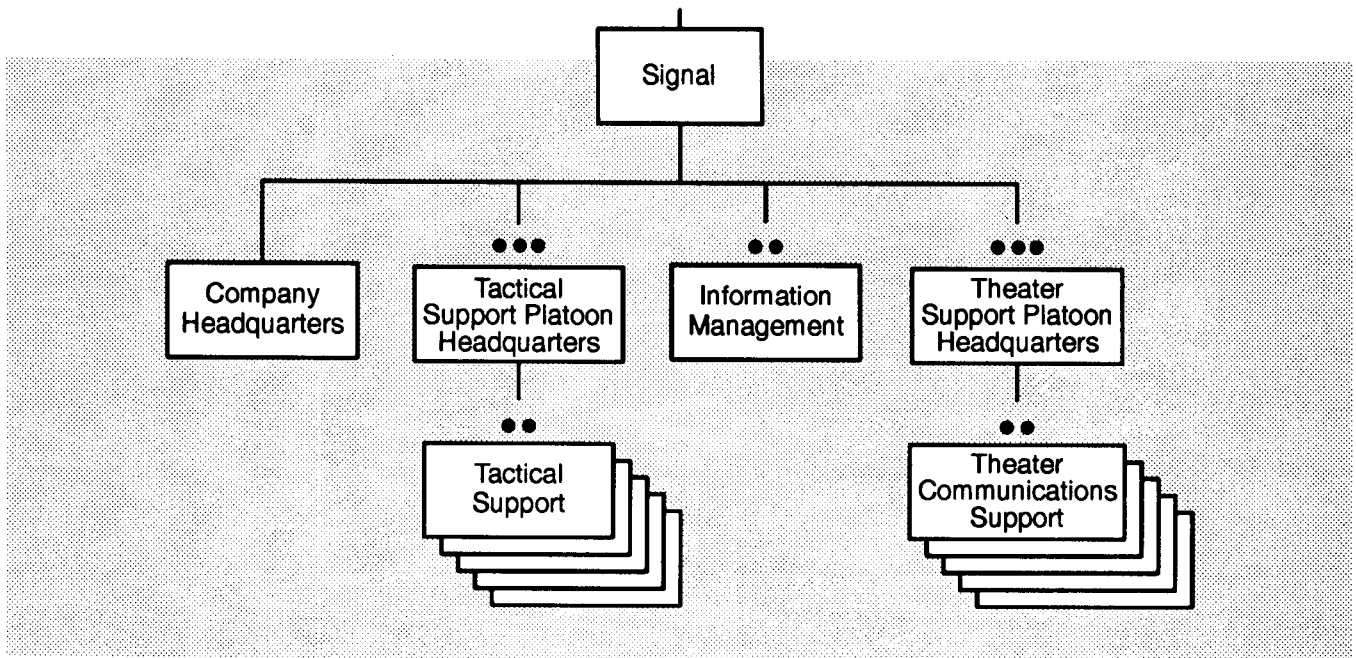

Figure 4-7. Signal company, PSYOP dissemination battalion (AC).

be able to provide simultaneous PSYOP support to two or more organizations within the combatant command, if required. The support company normally collocates with the support battalion headquarters and its commander serves as the headquarters commandant for the battalion headquarters. Should mission requirements dictate, the battalion headquarters may be realigned to support the unified command CINC and one major combatant command subordinate headquarters (for example, JTF commander), simultaneously.

The RSB staff performs the following functions. It—

- Deploys the entire RSB, as required, into a combatant command. It supports the unified command CINC or his designated representative (for example, JTF commander).
- Deploys (including airborne deployments) selected elements of the battalion to conduct assessments and establish and maintain liaison with supported units.
- Produces PSYOP appendixes and develops PSYOP supporting plans to all OPLANs and CONPLANs of all unified commands and their service component commands, SOCs, and JTFs.
- Briefs PSYOP concepts, plans, and products to senior flag officers, ambassadors, and high-level foreign national officials.
- Develops and has the attached PSYOP dissemination battalion assets produce all operational and tactical PSYOP printed, audio, and video products to support the unified command CINC or his designated representative (for example, JTF commander).
- Conducts pretests and posttests of PSYOP products.
- Collects PSYOP-relevant information from EPW, civilian internees, and local nationals, if possible, and gives the information to the RSB.
- Coordinates with appropriate government agency(s) and unit(s) for the dissemination of PSYOP products.
- Establishes reporting requirements for subordinate assigned and attached PSYOP units and/or sections.
- Advises supported commanders on the best use of PSYOP as well as the psychological implications of the supported unit's actions.
- Plans and executes counterpropaganda operations to neutralize enemy propaganda efforts directed against operations conducted by the combatant command.

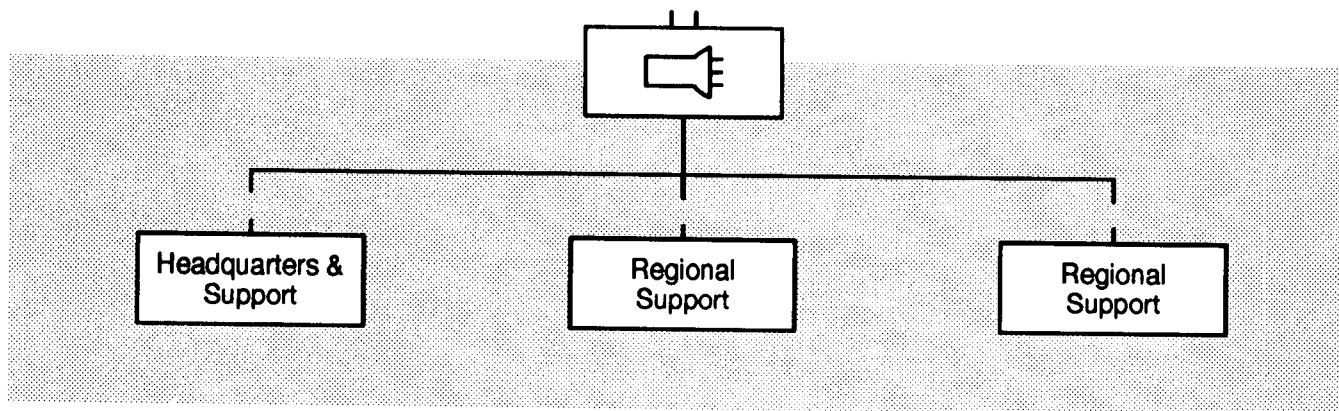

Figure 4-8. PSYOP regional support battalion (AC and RC).

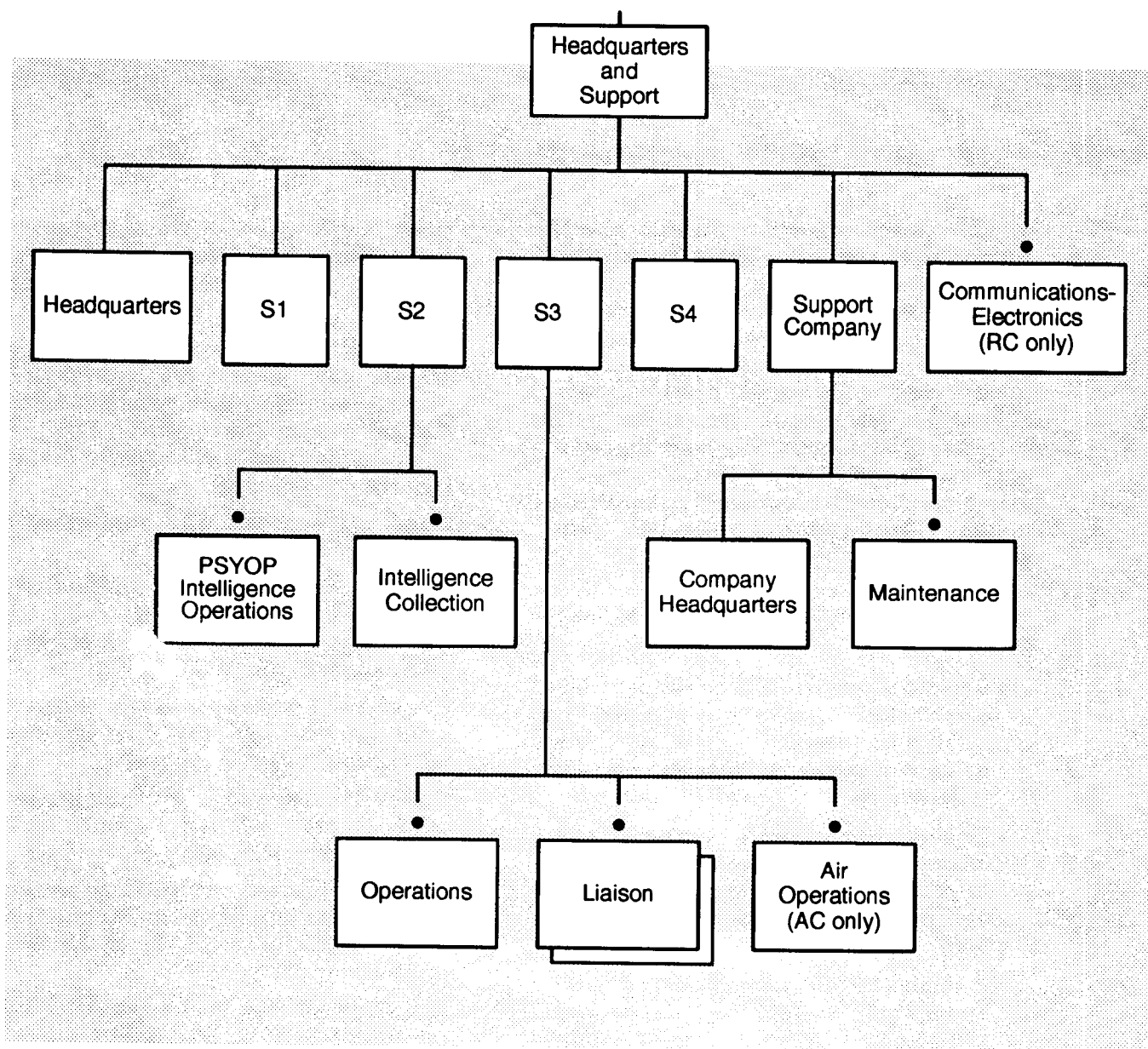

Figure 4-9. HSC, PSYOP regional and tactical support battalions (AC and RC).

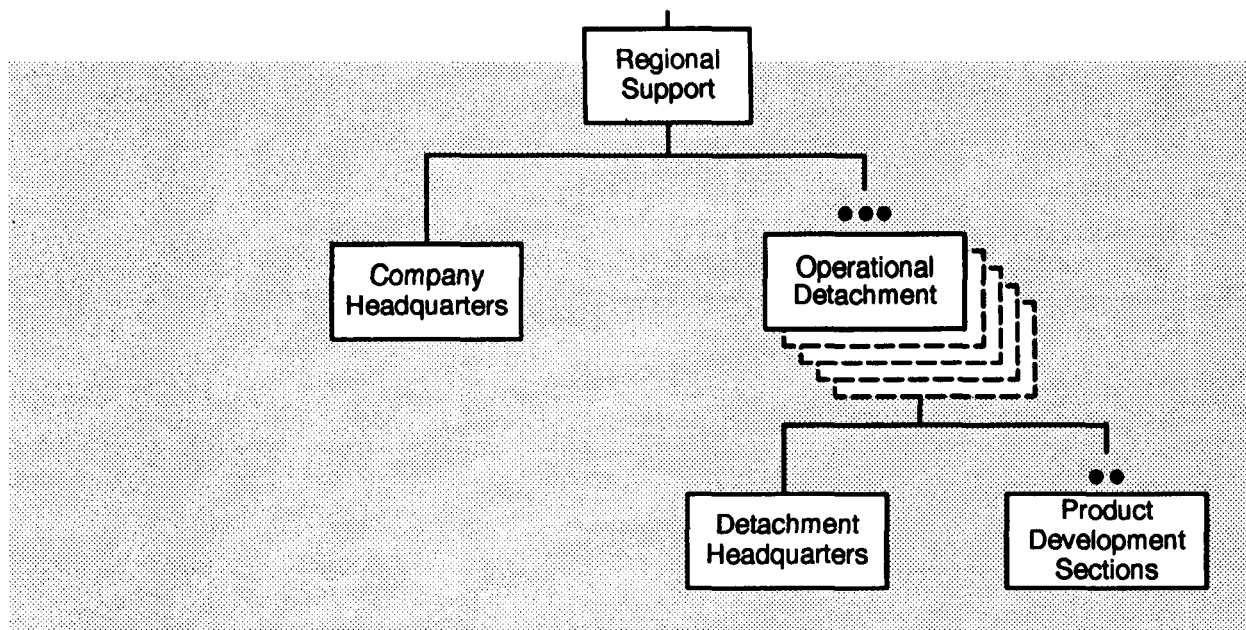

Figure 4-10. PSYOP regional support company (AC and RC).

REGIONAL SUPPORT COMPANY

The RSC consists of a headquarters element and two or more operational detachments. (See Figure 4-10.) The RSC supports the RSB. The product development sections of the operational detachments form the nucleus of the PSYOP product development process that produces operational PSYOP.

The RSC staff performs the following functions. It—

- Deploys the company (selected elements by airborne deployment) in support of the RSB.
- Develops and has the attached PSYOP dissemination battalion assets produce all operational and tactical PSYOP printed, audio, and video products to support the unified command CINC or his designated representative (for example, JTF commander).
- Provides liaison officers to supported units.
- Conducts pretests and posttests of PSYOP products.
- Collects PSYOP-relevant information from EPW, civilian internees, and local nationals, if possible, and gives the information to the RSB.
- Advises supported commanders on the best use of PSYOP as well as the psychological implications of the supported unit's actions.
- Plans and executes counterpropaganda operations to neutralize enemy propaganda efforts directed against operations conducted by the combatant command.

TACTICAL SUPPORT BATTALION

The tactical support battalion (TSB) (see Figure 4-11) provides tactical support for one rapid deployment corps' contingency requirements and, as required, the SOF community. The battalion consists of a headquarters and support company and

two tactical support companies. The TSBs mission requires numerous and simultaneous deployments (including airborne deployment) worldwide of small tactical support elements.

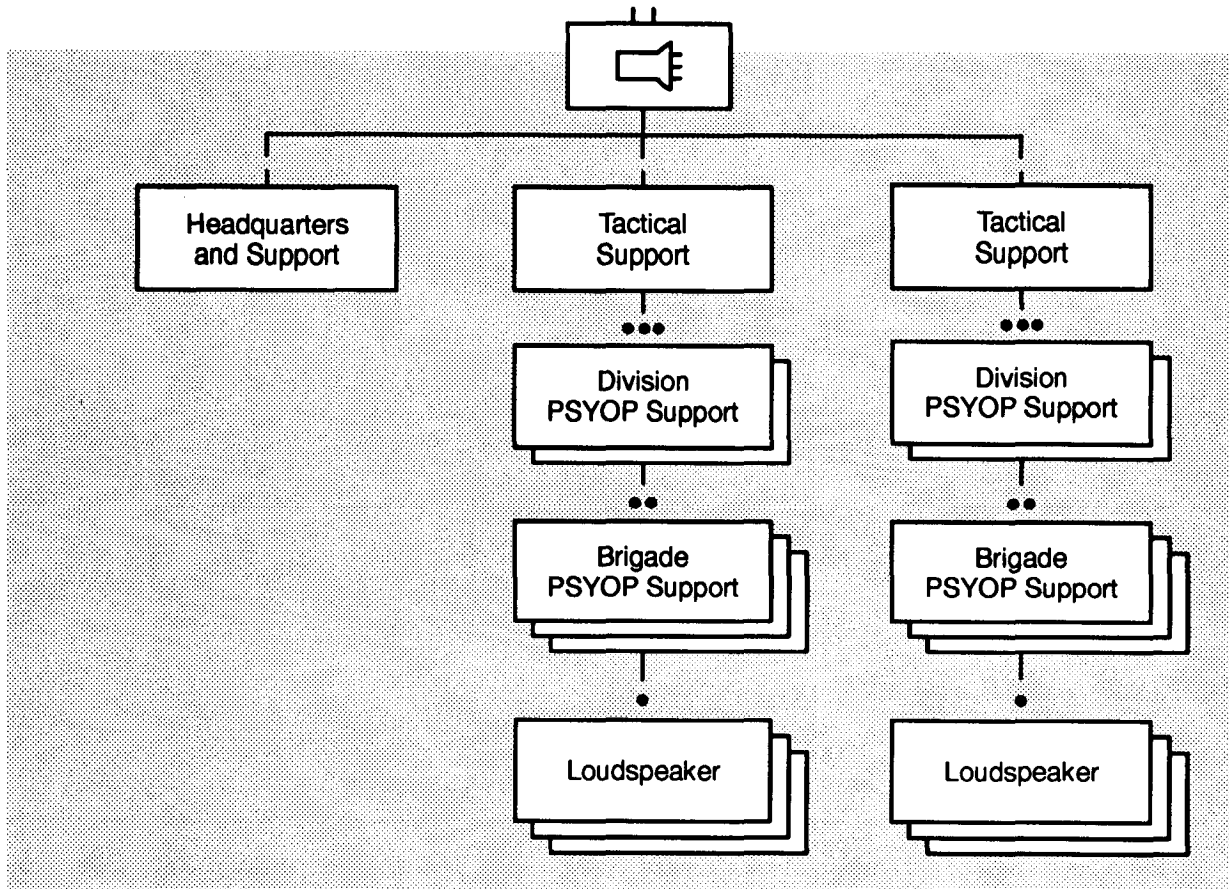

Figure 4-11. PSYOP tactical support battalion (AC and RC).

BATTALION HEADQUARTERS AND SUPPORT COMPANY

The TSB headquarters would not normally deploy as an entire unit. It is, however, capable of deploying up to two tactical support companies.

The battalion HSC staff (see Figure 4-9) performs the following functions:

- Manages and supervises-
 - Routine battalion-level administrative and logistics functions.
 - Detailed support planning.
 - Deployment package readiness management and execution.

- OPSEC planning, training, and coordination.
- Other information requirements (OIR) and/or priority intelligence requirements (PIR).
- EPW and civilian internee access.
- Security clearance programs.
- Furnishes supported unit headquarters with up to two tactical support companies, as required.
- Conducts PSYOP assessments in support of the JCS and NCA for peacetime contingencies or across the operational continuum.

TACTICAL SUPPORT COMPANY

The tactical support company (TSC) provides limited PSYOP product development and

product dissemination to support the Army rapid deployment corps, its maneuver units,

and, as required, the SOF community. (See Figures 4-12 and 4-13.) The unit is organized to provide tactical dissemination of products for the corps headquarters, or a designated division, across the operational continuum. Once in the combatant command, the TSC becomes OPCON to the JPOTG.

The TSC staff performs the following functions. It—

- Deploys PSYOP support packages consisting of division and/or brigade PSYOP support teams supporting the rapid deployment corps, or its designated maneuver units, and SF and ranger units, as required.

- Conducts airborne deployments of PSYOP support package(s) (personnel and equipment) (AC only).
- Disseminates tactical PSYOP products: for example, loudspeaker messages, handbills, leaflets, and face-to-face communications.
- Requires the division and/or brigade PSYOP support teams to advise the corps and maneuver unit commanders of the psychological implications of the supported unit's actions and the most efficient and productive use of PSYOP resources.
- Gives PSYOP situation reports to the JPOTF and/or POTF.

REGIONAL SUPPORT GROUP

The PSYOP regional support group (RSG) consists of an HHC, a PSYOP dissemination company, and three RSBs. (See Figure 4-14.) The RSG is designed to provide organic assets to enhance the capabilities of an AC or RC POTG or POTF, as required, and to plan and conduct forward presence activities with AC regional PSYOP forces. The group headquarters consists of the command group and the group staff. Members of the group staff include the S1, S2, S3, and S4 (Figure 4-15). All functions within these sections are performed IAW paragraph 2-7, FM 101-5.

The RSG staff performs the following functions. It—

- Provides product development functions at EAC for two regional conflicts and forward presence activities simultaneously.
- Conducts regional PSYOP supporting U.S. national goals and the unified CINCs.
- Exercises OPCON of organic and task-organized PSYOP assets.

PSYOP DISSEMINATION COMPANY (RC)

The PSYOP dissemination company provides audiovisual and printed materials production as well as radio and television broadcast capabilities supporting strategic PSYOP. This company is usually assigned to a PSYOP group, but may be attached, in whole or in part, to a PSYOP battalion operating as the senior PSYOP headquarters for a unified combatant commands peacetime operations. (See Figure 4-16.) The

company's organization allows great flexibility in its use. The radio engineering and media production platoons (with their organic equipment) may be deployed to the communications zone (COMMZ), may provide technicians to operate indigenous stations, or both. While normally considered a fixed facility, the heavy print shop can provide mass printed material production for delivery to the COMMZ(s) or deploy the heavy

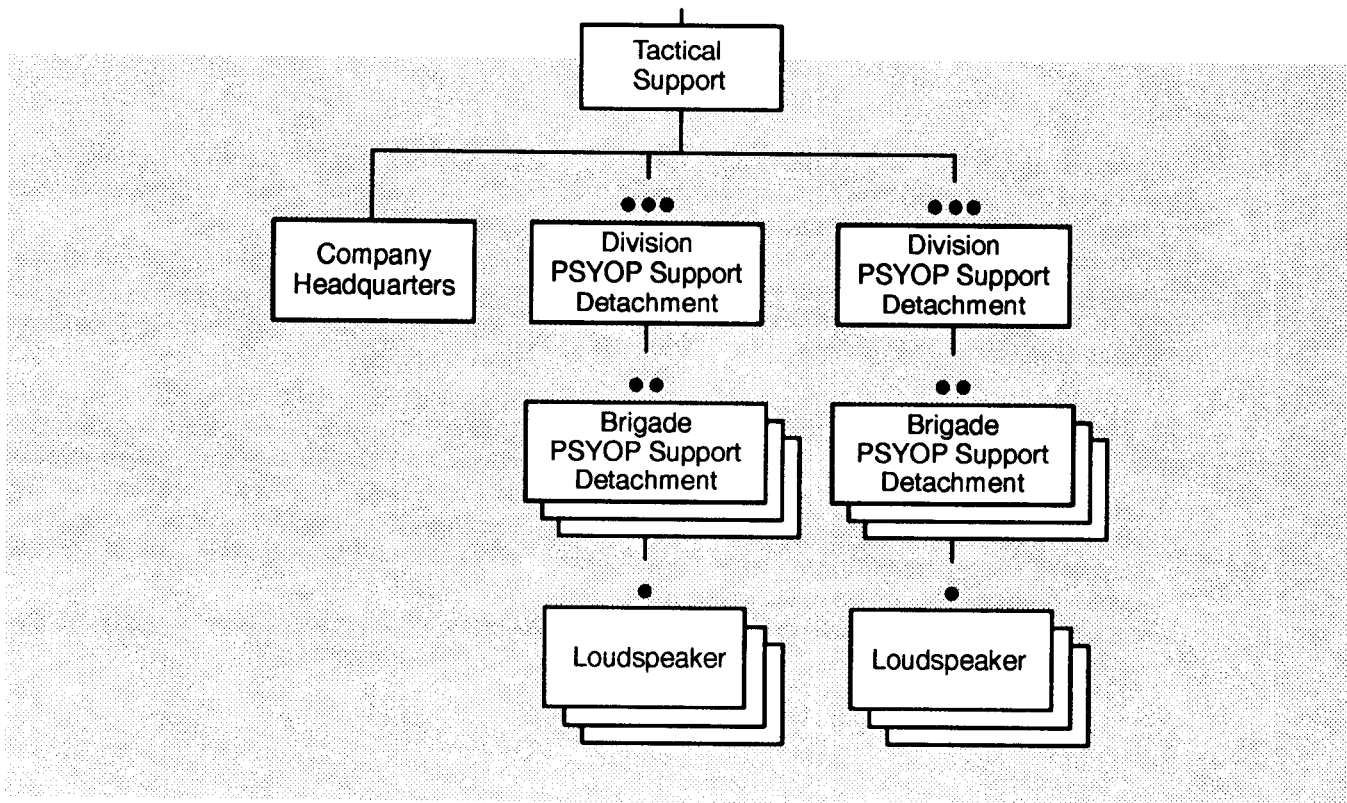

Figure 4-12. PSYOP tactical support company (AC).

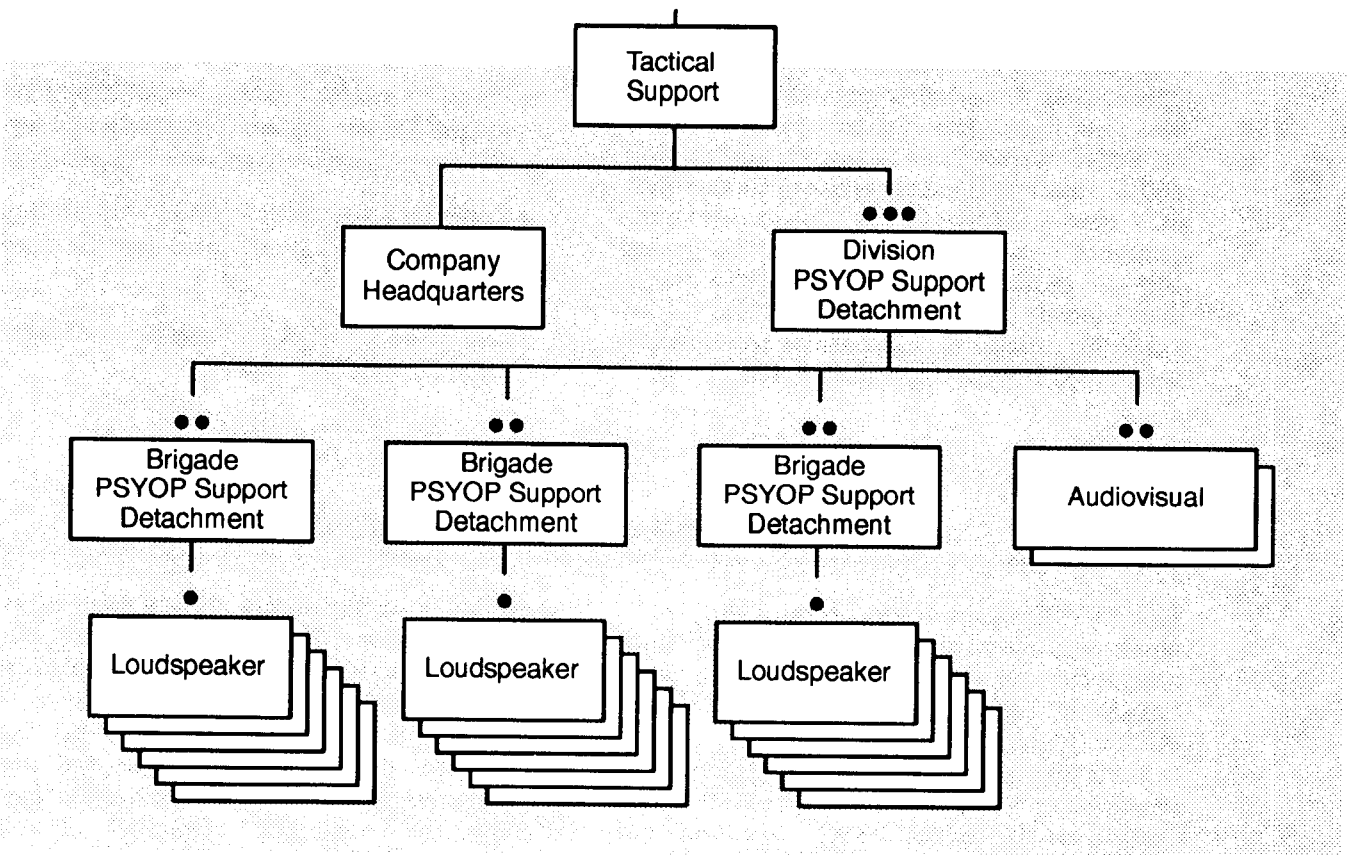

Figure 4-13. PSYOP tactical support company (RC).

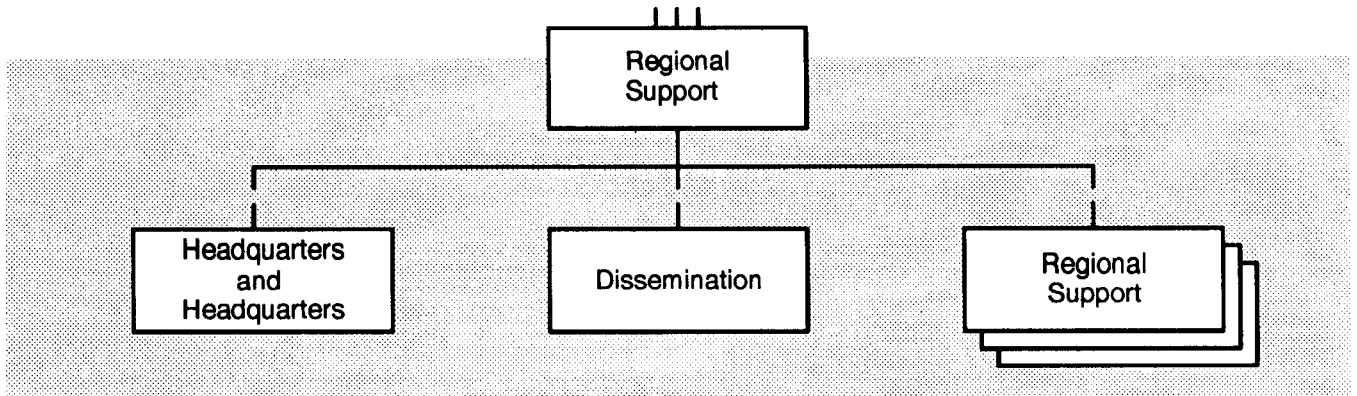

Figure 4-14. PSYOP regional support group (RC).

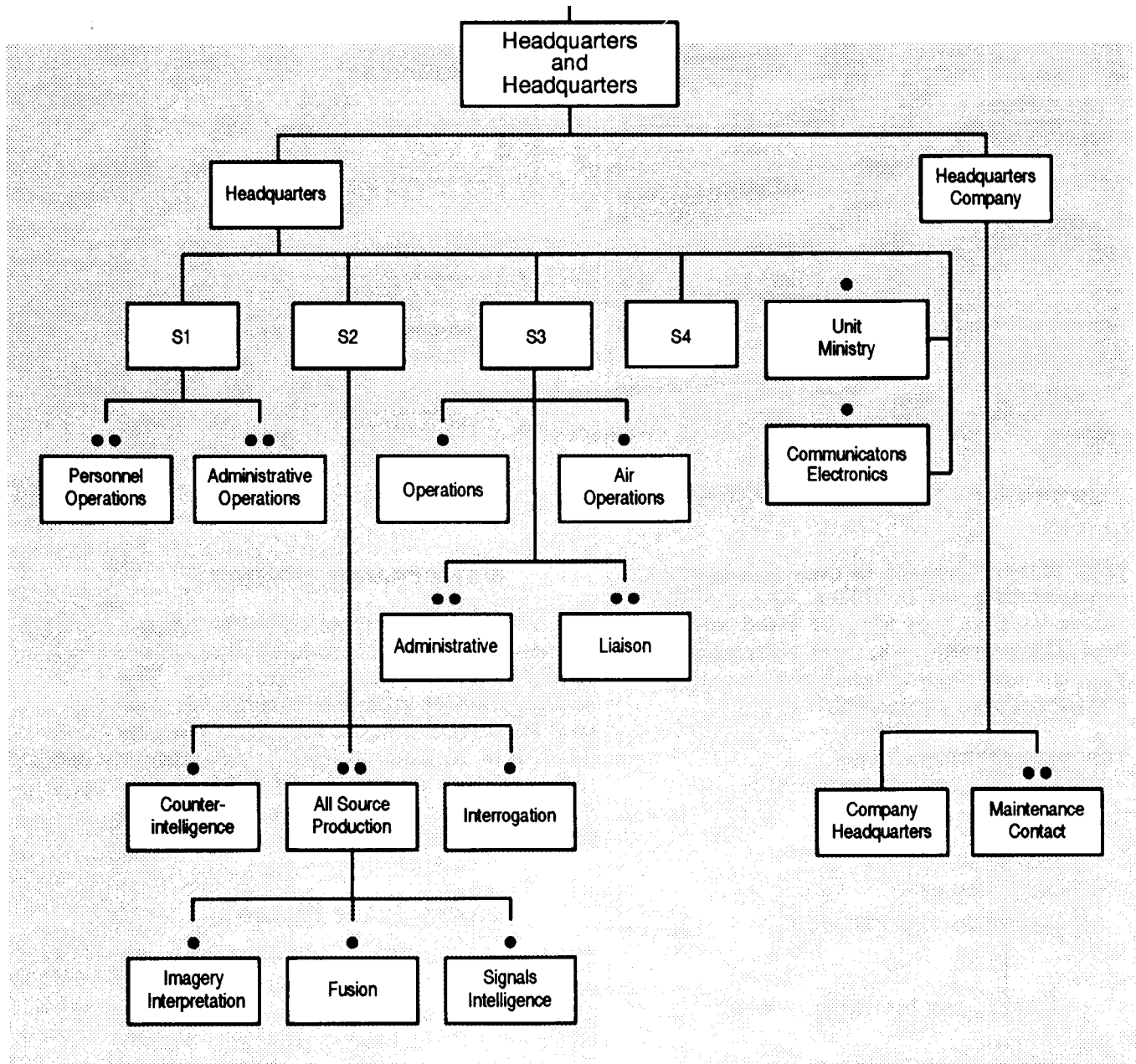

Figure 4-15. HHC, PSYOP regional support group (RC).

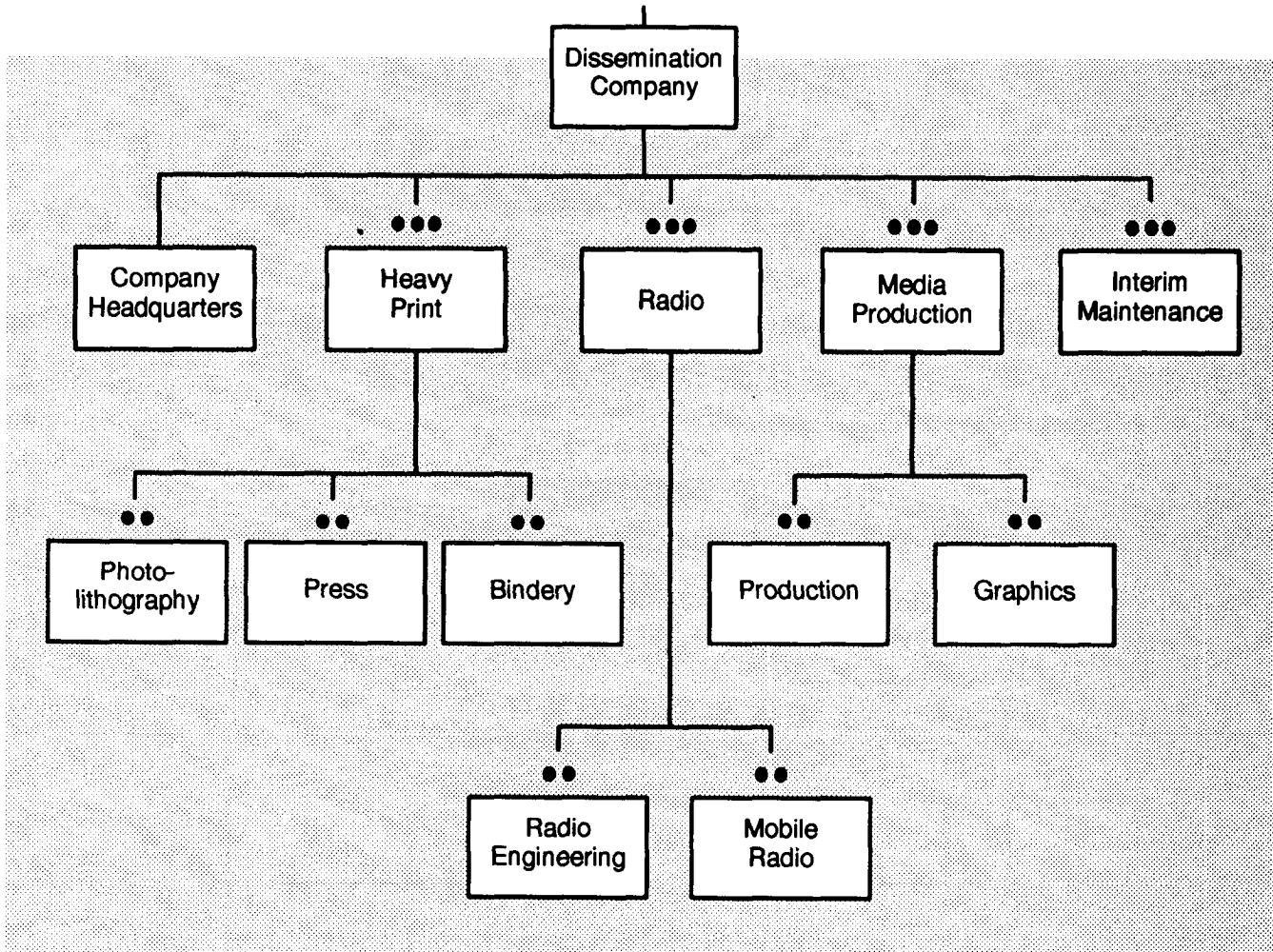

Figure 4-16. PSYOP dissemination company (RC).

print platoon forward to man and operate indigenous print facilities. The maintenance section may also be used and/or deployed as a unit or in three-man teams to perform unit maintenance and repair for PSYOP-peculiar equipment.

This company contains a—

- Company headquarters.
- Maintenance section.
- Heavy print platoon.
- Radio platoon.
- Media production platoon.

Company Headquarters

The company headquarters provides the personnel to supervise and administer the company.

Maintenance Section

The maintenance section contains the personnel to perform unit maintenance on the group's PSYOP-peculiar equipment. The section provides otherwise unavailable support for PSYOP-unique, low-density equipment. It is designed to operate as a unit or to be split into a maximum of three maintenance contact teams for attachment to and deployment with PSYOP battalions.

Heavy Print Platoon

The heavy print platoon consists of several elements. It contains a platoon headquarters that supervises and administers the Heavy Print Center. It has a photolithography section that prepares products for print (camera work, registration, and layout and platemaking). It has a press

section that operates the group's heavy print equipment that prints a high-volume of PSYOP materials. It has a bindery section that binds the PSYOP materials after its printing.

Radio Engineering Section

The radio engineering section contains personnel who prepare organic mobile and/or indigenous fixed broadcast radio equipment for radio broadcast and monitoring operations.

Mobile Radio Section

The mobile radio section contains personnel who prepare organic mobile and/or

indigenous fixed broadcast radio equipment for radio broadcast and monitoring operations.

Media Production Platoon

The media production platoon prepares and disseminates PSYOP materials through audio, audiovisual, printed, or related means. It contains a production section that transforms supplied products into broadcast scripts. It operates and maintains radio and TV broadcast equipment and produces radio and TV programs to disseminate products. It has a graphics section that provides visual and audiovisual products for use in print materials and in radio and TV broadcasts.

RESEARCH AND ANALYSIS COMPANY (RC)

The primary function of a research and analysis company (RAC) is to sustain in-depth analysis of multiple ethnolinguistic groups; assess psychological vulnerabilities of designated target audiences; plan PSYOP support to theater campaigns; and develop products and counterpropaganda to support special and conventional operations in a theater or operational area. RACs can provide PSYOP personnel to train foreign military personnel in PSYOP principles and techniques, when specifically directed to do so. Under current PSYOP force structure, the RAC is only found in the RC. (See Figure 4-17.) One RAC is allocated to each RC RSB. A RAC may, however, be deployed to the COMMZ and assigned to the AC PSYOP group or attached to an AC or RC PSYOP battalion when it is functioning as the senior PSYOP headquarters for a unified combatant command. A RAC consists of—

- A company headquarters.
- Two research and analysis sections, each having two target analysis teams and two research teams.
- A collection management and dissemination section.

Company Headquarters

The company headquarter provides the personnel to supervise and administer the RAC.

Research and Analysis Sections

The research and analysis section targets and prepares products for two ethnolinguistic groups using target analysis and research teams.

Target Analysis Team. The target analysis team analyzes audiences to identify their susceptibility to PSYOP. The team is designed to target two ethnolinguistic groups.

PSYOP Research Team. The PSYOP research team normally takes the themes nominated by the target analysis team and prepares specific products to exploit them. A team is designed to develop products for use with two ethnolinguistic groups.

Collection Management and Dissemination Section

The collection management and dissemination section contains the personnel required to perform intelligence management and

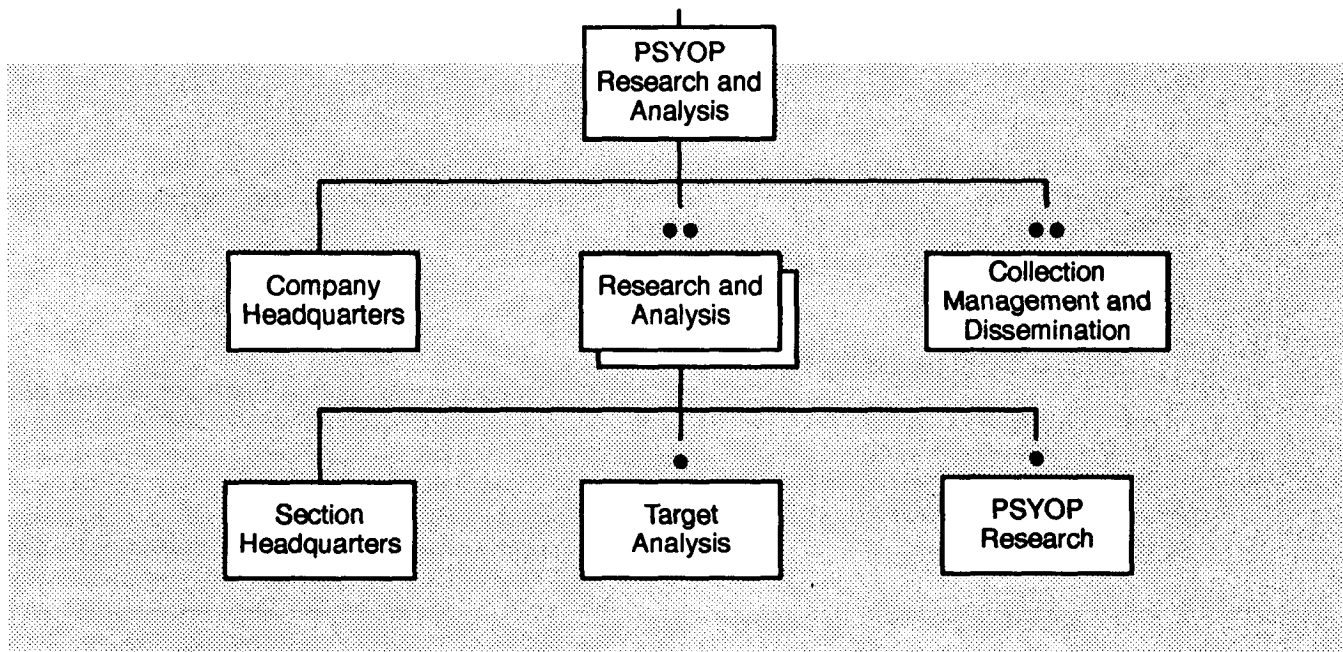

Figure 4-17. PSYOP research and analysis company (RC).

to control PSYOP product dissemination. Collection management ensures the identification of PSYOP information shortfalls and translates them into collection requirements for specific collection elements. Collection management also screens incoming information for PSYOP relevance so that PSYOP

analysts are not overwhelmed by the volume of information available. Collection management ensures supporting intelligence unit collection plans include PSYOP requirements. Dissemination control ensures the correct distribution of PSYOP products developed by the company.

TACTICAL SUPPORT GROUP (RC)

The PSYOP tactical support group (TSG) (Figure 4-18) consists of an HHC, a PSYOP dissemination battalion, and three TSBs. (See Figure 4-19.) The TSG is designed to conduct tactical PSYOP supporting U.S. elements of a unified, combined, or sub-unified command during forward presence activities and/or one regional conflict. In addition, the TSG provides organic assets to enhance the capabilities of an AC POTG or POTF and EPW and civilian internee assets supporting the POTG/POTF. The group headquarters consists of the command group and the group staff. Members of the group staff include the S1, S2, S3, and S4. All functions within these sections are performed IAW paragraph 2-7, FM 101-5.

The TSG staff performs the following functions. It—

- Simultaneously provides PSYOP command and staff support activities for up to two levels of command at EAC. One of the headquarters will be the immediate subordinate of the other.
- Conducts tactical PSYOP against enemy conventional and unconventional warfare forces in support of headquarter at EAC.
- Exercises OPCON of task-organized PSYOP forces providing support to major principal subordinate commands in the theater.
- Serves as senior tactical PSYOP headquarters supporting U.S. or allied commands at EAC during a regional conflict.

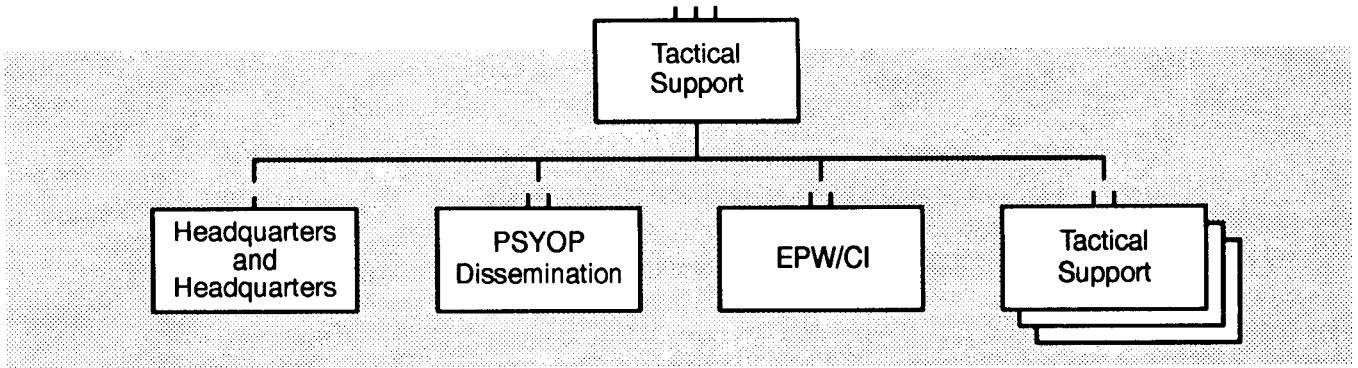

Figure 4-18. PSYOP tactical support group (RC).

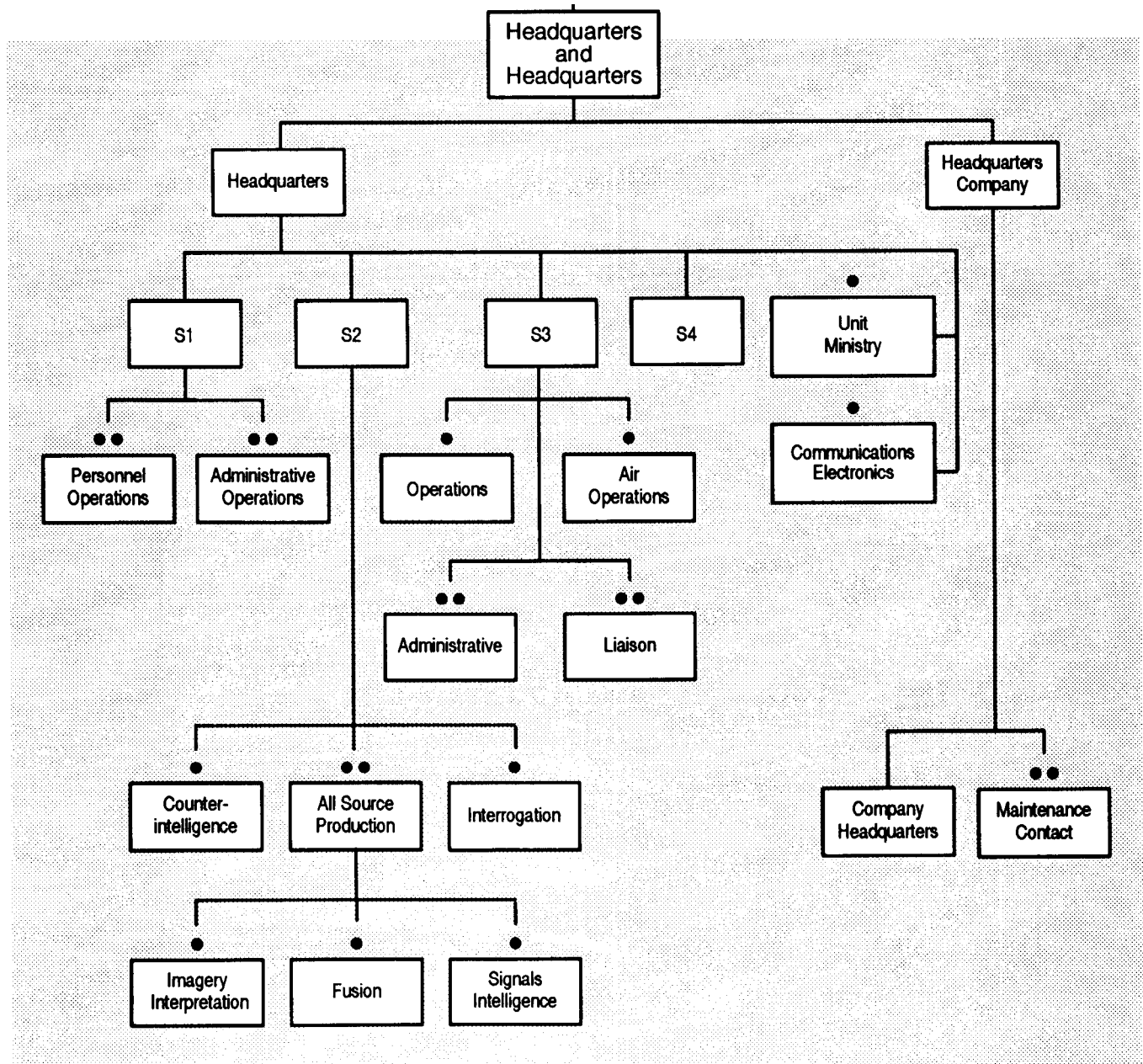

Figure 4-19. HHC, PSYOP tactical support group (RC).

PSYOP BATTALION (ENEMY PRISONER OF WAR/CIVILIAN INTERNEE) (RC)

The PSYOP battalion (EPW/CI) (Figure 4-20) provides PSYOP to support EPW and civilian internee operations at the corps and theater levels for two major regional conflicts. See Appendix E for information on how this battalion supports EPW and

civilian internee operations. The battalion consists of a headquarters and support company and two EPW/CI support companies. The mission of the battalion requires the simultaneous deployment of two EPW/CI task forces.

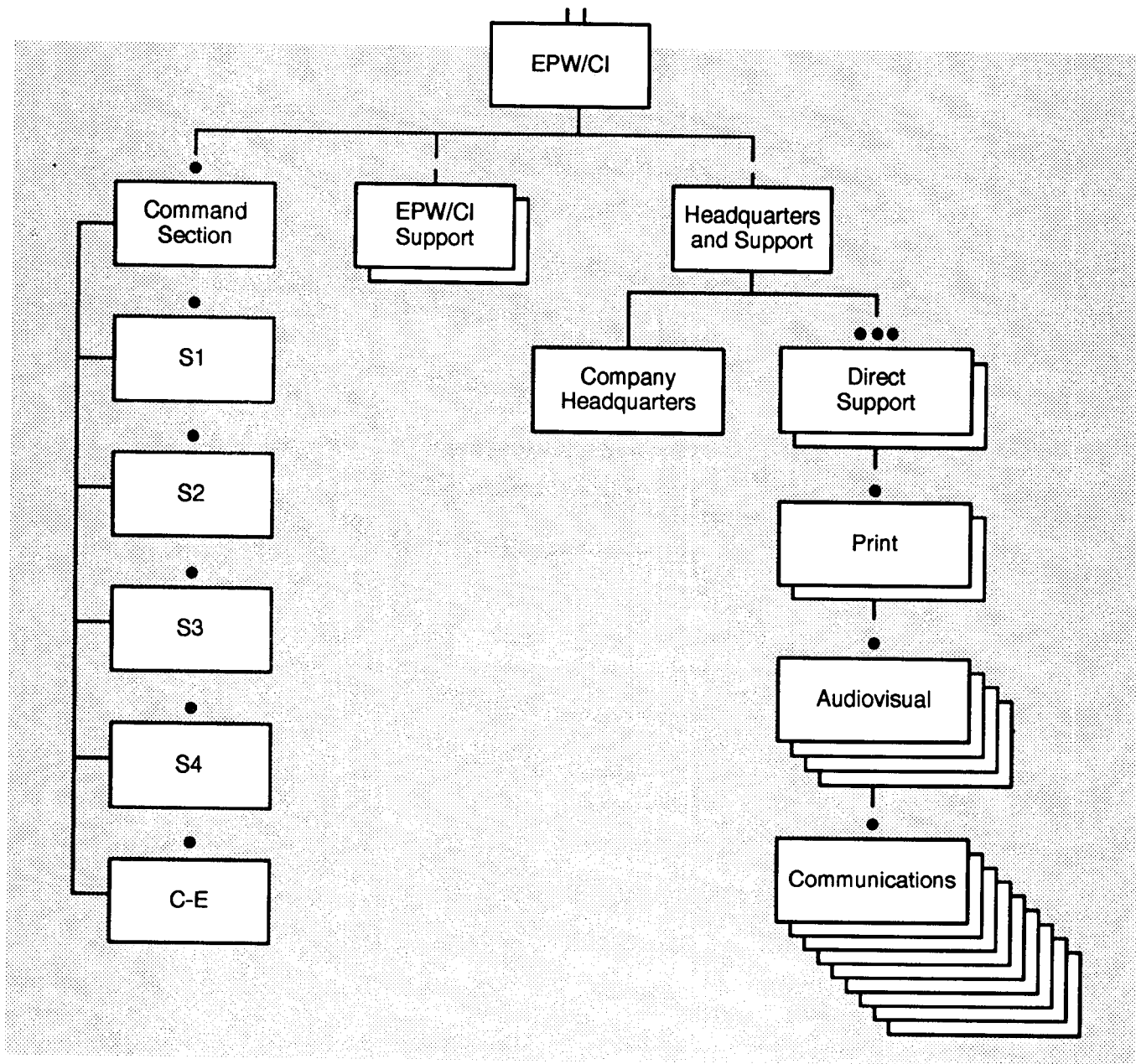

Figure 4-20. Enemy prisoner of war/civilian internee (EPW/CI) battalion (RC).

BATTALION HEADQUARTERS AND SERVICE COMPANY (RC)

The PSYOP battalion (EPW/CI) headquarters would not normally deploy as an entire unit. It is, however, capable of deploying two EPW/CI support companies with a support element.

The EPW/CI support battalion headquarters and service staff performs the following functions:

- Manages and supervises the routine battalion-level administrative and logistics functions, detailed support planning, deployment package readiness

management and execution, training and coordination, OIR/PIR, EPW/CI access, and security clearance programs.

- Furnishes supported PSYOP headquarters (POTG/POTF) with up to one EPW/CI support company on a one-per-conflict basis.
- Conducts EPW and civilian internee PSYOP assessments that support the JCS and NCA for peacetime planning and for contingencies across the operational continuum.

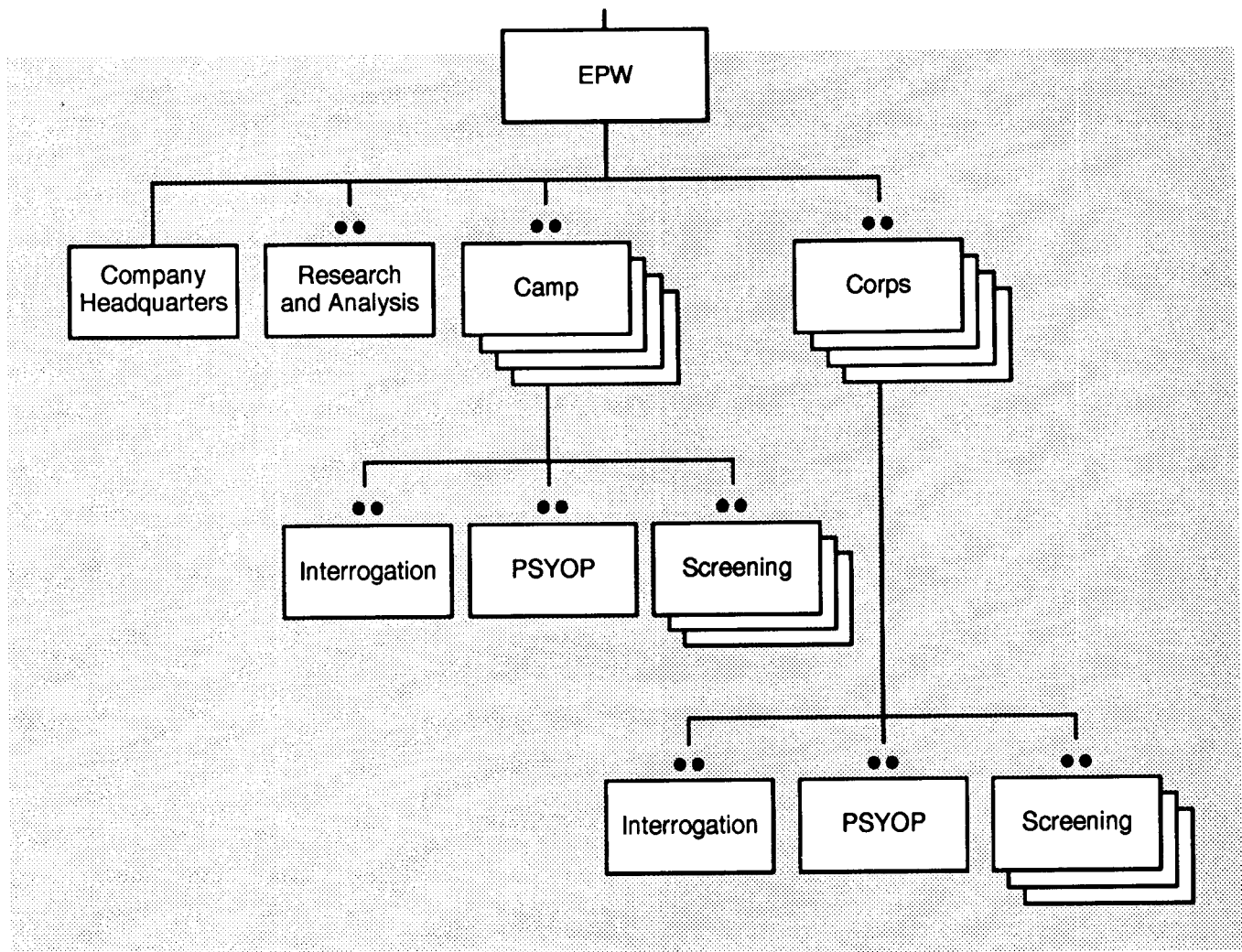

Figure 4-21. PSYOP support company (EPW/CI) (RC).

PSYOP ENEMY PRISONER OF WAR/CIVILIAN INTERNEE SUPPORT COMPANY

The EPW/CI support company (Figure 4-21) provides PSYOP support for EPW and civilian internee operations supporting one major regional conflict at corps and theater levels.

The EPW support company performs the following functions:

- Conducts direct support PSYOP of EPW/CI operations.
- Conducts EPW and civilian internee pacification campaigns.
- Provides corps-level EPW and civilian internee facility commanders advice and PSYOP assets and support to control EPW civilian internee populations in emergency situations.
- Identifies malcontents, rabble-rousers, political officers, and trained agitators.
- Identifies key communicators.
- Collects PSYOP relevant information that supports the POTF/POTG.
- Provides the EPW and civilian internee camp commanders advice and PSYOP support to improve relations with civilian populations surrounding the camp facility.
- Conducts pretests and posttests of products supporting the POTG/POTF.
- Coordinates and provides PSYOP support to counter enemy PSYOP efforts or actions in the vicinity of the EPW and civilian facility.
- Produces PSYOP products with and under the control of the POTF/POTG.

Chapter 5

Command and Control

PSYOP may operate under various C² arrangements. The mission, the length and scope of operations, the supported CINC, and the commanders at each level determine the exact C² structure. PSYOP may be an integral part of an overall military COA or an activity independent of other military operations. This chapter discusses the C² structure as it relates to the Army PSYOP force. This discussion focuses on C² arrangements and the command relationships developed within them at the unified combatant command level.

OVERVIEW OF PSYOP C² CONSIDERATIONS

All psychological operations are normally joint. Under Joint Pub 3-53, PSYOP may be executed in a national, joint, combined, or single Service context. Commands that direct the use of PSYOP include unified or specified combatant commands, subordinate unified commands, and joint task forces. The principles of war (see Chapter 1) are the basis for joint PSYOP doctrine. These principles do not try to constrain the Service department additions or deletions. They are, however, the focal point for planning and executing joint PSYOP.

The mission, the length and scope of operations, the supported CINC, and the commanders at each level determine the exact C² structure.

Psychological operations may be an integral part of an overall military COA or an activity independent of other military operations.

Effective PSYOP need a responsive C² structure. The command relationship arrangements for C² of PSYOP must—

- Provide a clear, unambiguous chain of command.
- Avoid frequent changes of support relationships among supported commanders involving PSYOP units.
- Provide enough staff experience and expertise to plan, conduct, and support PSYOP.
- Ensure that the supported commander involves selected PSYOP personnel in mission planning at the outset.

ORGANIZATION FOR NATIONAL SECURITY

The organization for national security is fully outlined in FM 100-25. PSYOP commanders and planners must be aware of

these organizations and their relation to PSYOP policy flow and direction.

JOINT CHIEFS OF STAFF

The JCS consist of the Chairman of the Joint Chiefs of Staff (CJCS) and the four Service chiefs. (See Figure 5-1.) See Appendix G for information on the responsibilities of the JCS and other military services. By law, the CJCS is the NCA's and the NSC's principal military advisor. He consults with and seeks the advice of the other JCS members and the CINCs. However, all JCS members are also statutory military advisors and may respond to a request or voluntarily submit advice or opinions directly to the NCA.

The JCS have no executive authority to command combatant forces. The CJCS alone functions within the chain of command by sending the NCA's orders and other communications to the CINCs. The CINCs report to the NCA through the CJCS, who acts as their spokesman, especially on the operational needs of their commands. Further, the NCA may assign oversight duties to the CJCS to help the NCA perform its command functions. The Vice Chairman of the Joint Chiefs of Staff (VCJCS), although not a JCS member, may take part in all JCS meetings. He performs the CJCS's duties in his absence.

By law, the direction of the Joint Staff rests exclusively with the CJCS. The Joint Staff does not have executive authority over combatant forces. The Joint Staff assists the CJCS with—

- Unified strategic direction of the combatant forces.
- Unified operation of the combatant commands.

- Integration of land, naval, and air forces into an efficient team.

The organizational templates for the Joint Staff directorates and agencies continue to evolve into current policy and doctrine-driven formats. Figure 5-2 outlines the current PSYOP-specific template. The J33 reports through the J31 (Deputy), to the J3. It controls the Joint Operations Division (JOD), the counternarcotics operations division (CNOD), the special operations division (SOD), and the special technical operations division (STOD). The SOD controls the support branch, the CT branch, the UW branch, and the psychological operations and civil affairs branch (PCB). The PCB, composed of only six officers from the various Services, provides the J3 SOD limited analyses, evaluations, and recommendations on PSYOP and CA policies, programs, and campaigns. The SOD is the focal point for the operational aspects of PSYOP use. It brings PSYOP issues outside the functional area to the attention of the proper joint staff directorate or agency. It also coordinates PSYOP issues in other functional areas, assesses the impact on PSYOP readiness and capabilities, and makes sure PSYOP policy, strategy, doctrine, and resource guidance are part of national security programs.

The Worldwide Military Command and Control System (WWMCCS) supports the NCA in exercising their command function. WWMCCS provides liaison among the NCA, JCS, and other components of the National Military Command System (NMCS), down to the CINCs' component commanders.

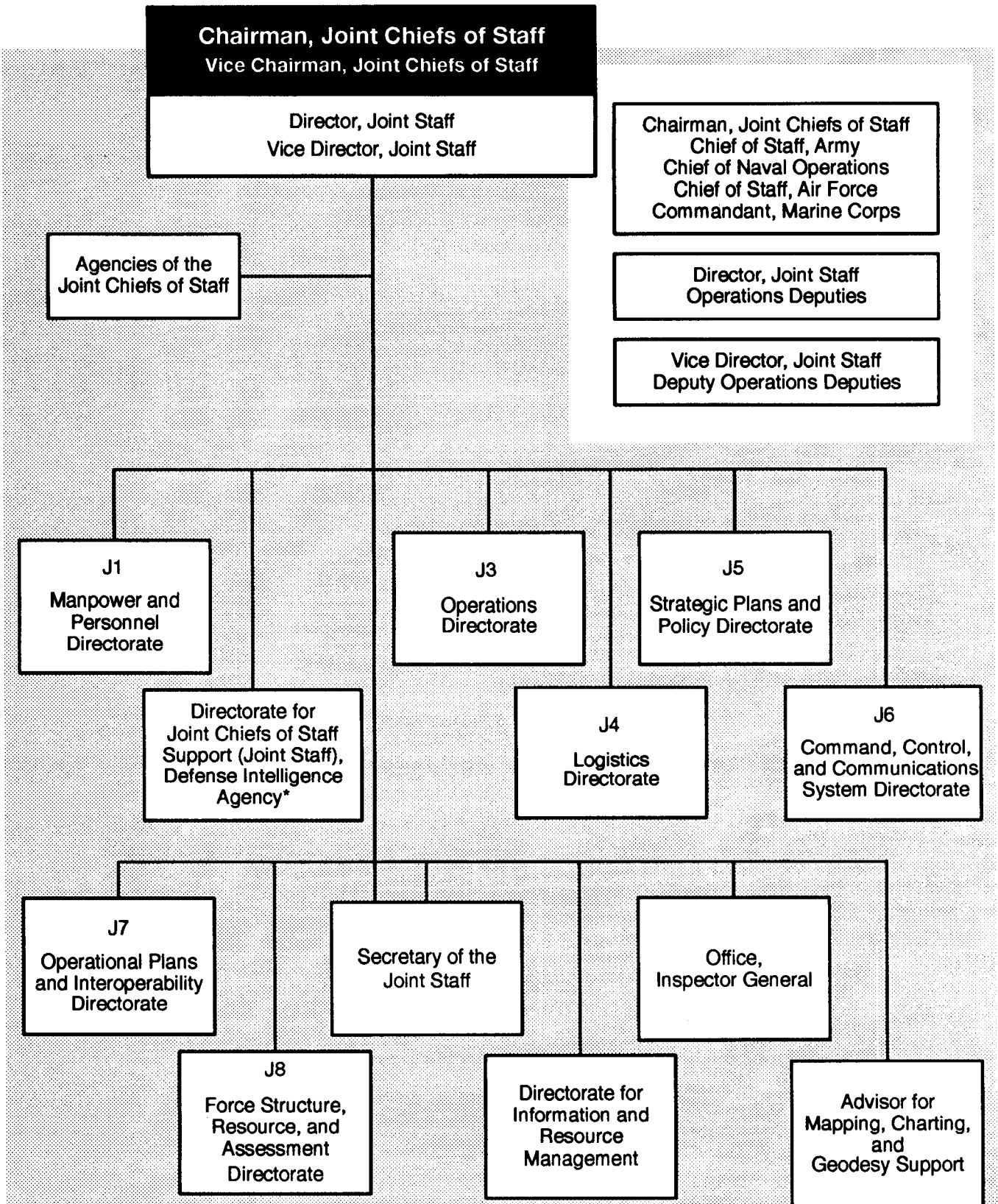

*Joint Staff functional responsibilities similar to a J2. The Director, Defense Intelligence Agency, also functions as the J2, Joint Staff.

Figure 5-1. JCS organization.

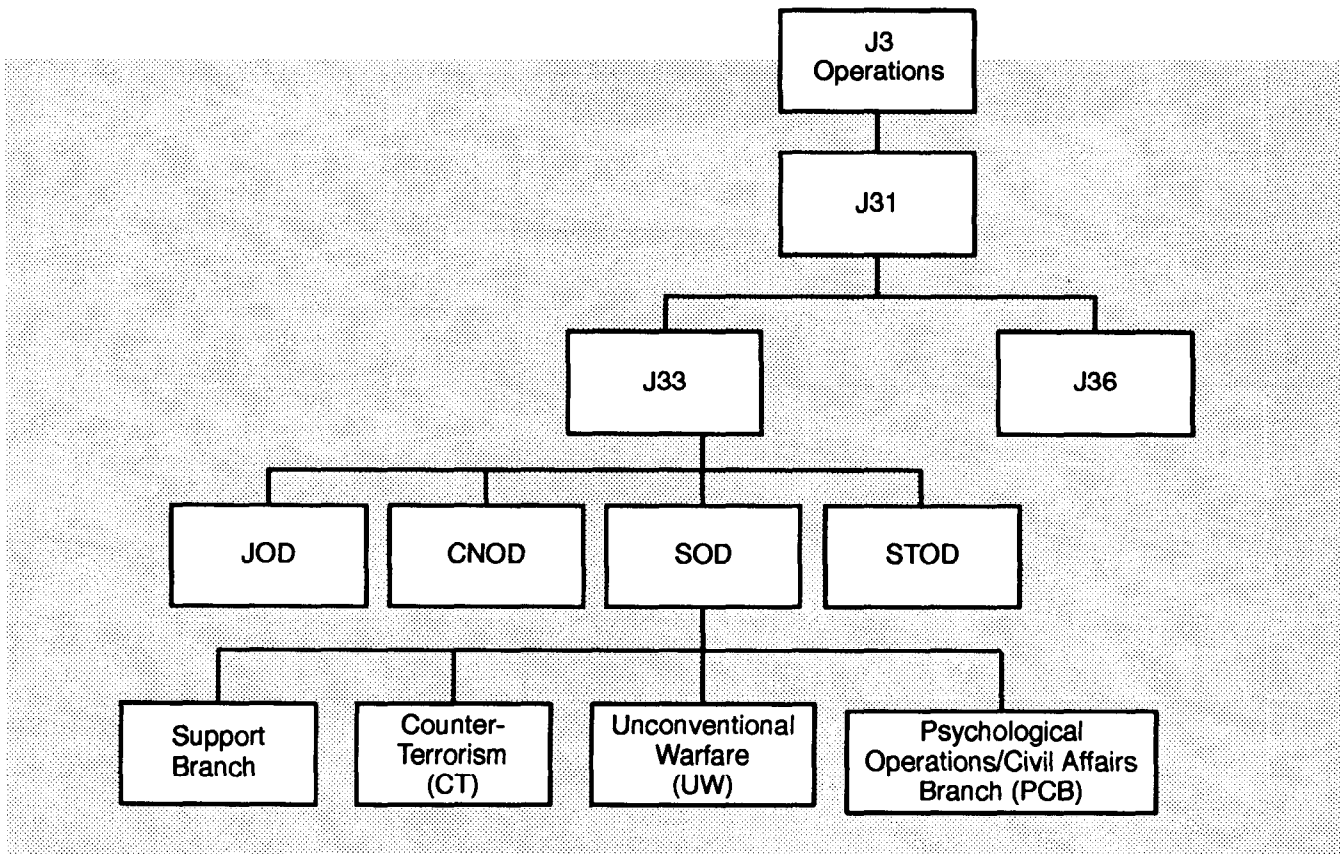

Figure 5-2. Partial (PSYOP-specific) joint staff template.

COMBATANT COMMAND ORGANIZATION

A combatant command is a command with broad, continuing missions requiring the strategic direction of armed forces under unified control. (See Figure 5-3.) The following paragraphs explain how the combatant command CINCs exercise COCOM and get support.

Unified Combatant Command

A unified combatant command has forces from two or more military Services. The CINC reports directly through the CJCS to the NCA. The CINC may be responsible for conducting military operations within a regional area or on a worldwide basis.

Regional CINCs

Five unified commanders have geographic area responsibilities. The Unified Command

Plan assigns an AOR. The CINCs provide strategic direction to all U.S. military operations within their designated AOR. Unless otherwise directed by the NCA, the regional CINCs have directive authority over all elements of their commands. This authority extends to the conduct of relationships with other unified combatant commands, DOD elements, U.S. diplomatic missions, and other U.S. agencies. These regional unified commands are

- United States Atlantic Command (USLANTCOM).
- United States Central Command (USCENTCOM).
- United States European Command (USEUCOM).
- United States Pacific Command (USPACOM).
- United States Southern Command (USSOUTHCOM).

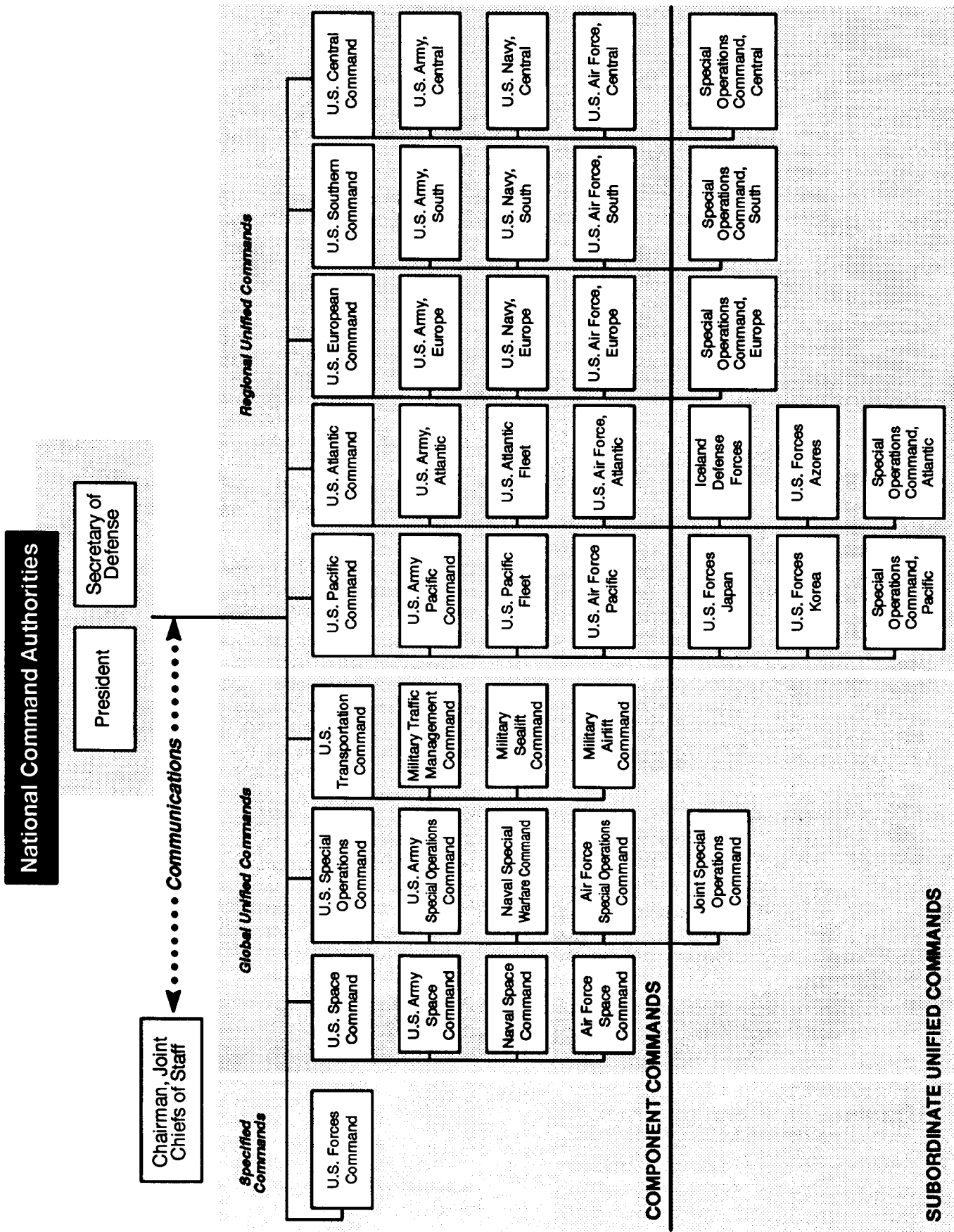

Figure 5-3. Combatant command organization.

Global CINCs

The CINCs of the other three unified commands have worldwide functional responsibilities not bounded by any single AOR. These functional combatant commands are the-

- United States Space Command (USSPACECOM).
- United States Special Operations Command (USSOCOM).
- United States Transportation Command (USTRANSCOM).

Specified Command

The specified command—the Forces Command (FORSCOM) (Army) -includes many forces from only one military Service. (It may include units and staff representation from other Services.) The specified CINC has the same authority and responsibilities as a unified CINC, except he cannot establish subordinate unified commands.

Combatant Command

COCOM is the command authority vested in the CINCs by public law. In the exercise of COCOM over assigned forces, a CINC can—

- Exercise or delegate OPCON. (The subordinate elements include all aspects of military operations, joint training, and logistics that affect mission accomplishment.)
- Coordinate the boundaries of geographic areas with other CINCs.
- Prescribe the chain of command within the command.
- Organize and employ commands and forces to carry out assigned missions.
- Assign tasks and designate objectives.
- Coordinate with Service components and approve those aspects of administration, support, and discipline that affect mission accomplishment.

- Concur in the assignment of subordinate commanders and combatant command staff.

Acting directly and through his Service component commander, the CINC actively participates in the DOD planning, programming, and budgeting system (PPBS). He submits comments and recommendations on proposed DOD policy, strategy, and apportionment of forces and resources. He gives the SECDEF a list that ranks his own essential requirements. He reviews and comments on Service programmed budget request. As directed by the SECDEF, he prepares program and budget proposals for his command.

COCOM resides only with the CINC. It is not transferable. The CINC may exercise COCOM through—

- Service component commanders; normally, he exercises COCOM through the Service component commander.
- Functional component commanders, if established for a particular operational purpose (for example, JPOTG commander). CINCs may assign a range of responsibilities they think proper to the situation to designated functional component commanders such as making recommendations on the employment of forces, planning, coordinating, and conducting operations. The authority given to a functional component commander is commensurate with assigned responsibilities. If forces are assigned or attached for the conduct of operations, the functional component commander is given OPCON of those forces.
- A subordinate unified command (unified command only).
- A single-Service force commander reporting directly to the CINC. Normally, missions requiring operations of a single-service force will be assigned to the applicable Service component commander. Under exceptional circumstances, a CINC may establish a separate single-Service force.
- The commander of a JTF who reports directly to the CINC.

- Directly over specific operational forces that, because of the mission assigned and the urgency of the situation, must remain immediately responsive to the CINC.

The CINC delegates to subordinate commanders proper authority to perform their assigned missions. He primarily concerns himself with broad operational matters and leaves administrative and support problems to the Service components.

Operational Control

The CINC may exercise OPCON or he may delegate OPCON to any level of command subordinate to him. Inherent in OPCON are authorities similar to those contained in COCOM. OPCON does not in and of itself include authoritative direction for logistics or matters of administration, discipline, internal organization, or unit training.

Tactical Control (TACON)

The CINC may exercise TACON or delegate it to any level of command subordinate to him. TACON does not include organizational authority or authoritative direction for administrative and logistic support. The establishing directive must define the specific authorities and limits of TACON.

Support

The support concept is essential to understanding the unified combatant command system. Support is the action of a force that aids, protects, complements, or sustains another force LAW a directive requiring such action (Joint Pub 1-02). The SECDEF or superior commander decides that one force can aid another force without being under its command or OPCON. He then directs the "supporting commander" to support the "supported commander." The superior commander specifies the degree of support. (See Figure 5-4.)

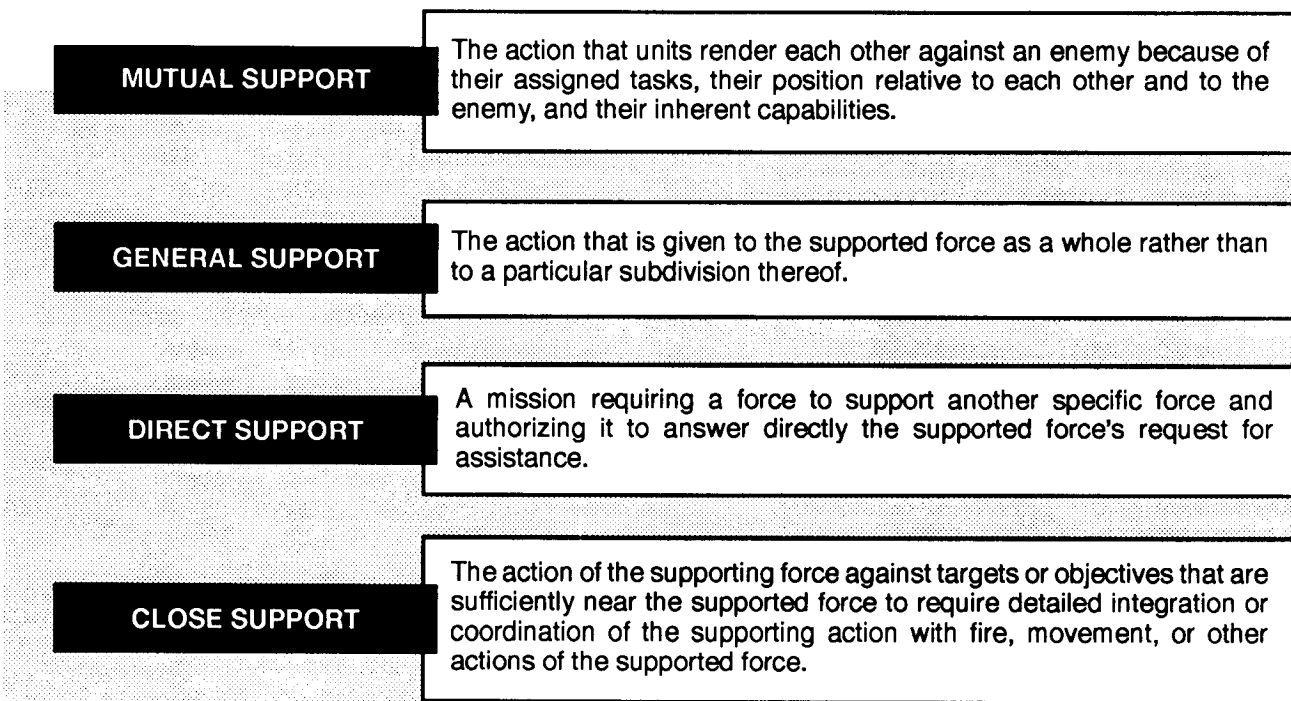

Figure 5-4. Degrees of support.

Unless otherwise specified, the supported commander has the authority to exercise general direction of the supporting effort. The supported commander provides the supporting commander all the particulars on the support missions he wants fulfilled. The supported commander also provides the information needed to coordinate the supporting force's actions with those of his own force.

Support must be consistent with the priorities and requirements of other assigned tasks. The supporting commander normally prescribes the tactics, methods, and procedures used by his force to provide the required support. (See Joint Pub 0-2 for a detailed discussion of support.)

Coordinating Authority

Coordinating authority is the authority to coordinate specific functions and activities involving two or more forces. The establishing directive specifies the common task to be coordinated without disturbing other organizational relationships of the forces. The commander or individual exercising coordinating authority can require consultation between the agencies involved but cannot compel agreement. Coordinating authority applies more to planning than to operations.

Relationships Among Combatant Commands

Concurrently countering multiple threats in various theaters could severely strain U.S. resourcing capabilities. The NCA make the determination of the priority of resourcing. The NCA, with the CJCS's advice, makes the subsequent allocation of forces. To counter the most dangerous threats, operations may be conducted sequentially, allowing adequate resourcing at critical points. The theater in which operations are most critical is assigned priority of resources and is referred to as the theater of focus. This theater receives the preponderance of

available resources, thus ensuring a concentration of enough forces to secure the most vital strategic goals. Theaters in which risk is accepted, to allow for a concentration of force elsewhere, are called economy of force theaters. Commanders of economy of force theaters have total latitude in conducting operations to accomplish their assigned objectives, as long as they do not require forces and resources beyond those originally apportioned. Theaters that have not received the required resources for the operation but may receive them when available are called deferred theaters. All theater commanders, regardless of theater category, develop OPLANs and conduct the combat operations needed to reach their assigned goals. However, they do so without expectation of reinforcement by forces other than those originally apportioned.

CINCs must maintain a global perspective as the relationship of one command to another will vary as NCA priorities are adjusted. These conditions determine the relationship between a supporting CINC and a supported CINC and the level and type of interagency effort at national and regional levels.

CINC internal theater structures must ensure the capability to coordinate matters with other combatant commanders. The SECDEF, through the CJCS, may direct one CINC to support another CINC. The direction each receives on the supported and supporting relationships outlines the degree of coordination and cooperation needed for operational harmony. Normally, these directions will establish the exchange of liaison, the procedures for conducting operations along adjacent boundaries, the reports between commands, the duration of operations, and other required supporting details. SO present a unique situation. Usually, USCINCSOC is a supporting commander, providing SOF to commanders of unified commands who, in turn, exercise COCOM over those forces. However, in certain situations, and only at the direction of the NCA, forces assigned to and under the COCOM of USCINCSOC may be employed in another CINC's theater.

THEATER ORGANIZATION

A CINC's AOR is the theater. CINCs organize a theater of war when an area of land, sea, air, or space within the theater becomes directly involved in wartime operations. The theater of war will be confined to the area of hostilities but may not include the entire theater. The NCA, through the CJCS can also designate a theater of war when hostilities involve more than one CINC's AOR. If, within single theaters, CINCs decide to subdivide a theater of war to contend with more than one major threat, they may designate subordinate theaters of operations for each major threat. A theater of operations is that portion of a theater of war necessary for military operations and for the administration of such operations.

The U.S. regional CINC may or may not be the theater of war commander. In NATO, for example, USEUCOM transfers its operational authority to NATO's Allied Command Europe (ACE). ACE becomes a combined theater of war command, and USEUCOM is largely a supporting headquarters. Making the U.S. regional CINC the combined theater of war commander often eases this transition. Within this manual, assume the U.S. regional CINC to be the regional strategic commander (theater CINC).

Each theater of operations commander is responsible for military operations in his part of the theater of war. For example, NATO'S

ACE has three subordinate theater of operations commands:

- Allied Forces, Northwest Europe (AFNORTHWEST).
- Allied Forces, Central Europe (AFCENT).
- Allied Forces, Southern Europe (AFSOUTH).

Unified Operations

Unified operations are theater strategic operations. They involve all types of Service and joint military operations. The regional CINC directs them to achieve a strategic goal. (See Joint Pubs 0-2 and 3-0 for more information on the principles and joint doctrine for unified operations.) A unified operation typically includes

- Joint, combined, or land, sea, air, and space operations.
- Joint SO.
- Joint PSYOP.
- Joint and Service activities.

Areas of Conflict

The NCA or U.S. regional CINC may not set up a theater of war or theater of operations in conflict areas. They assign a joint operations area (JOA) to the joint force commander (JFC) responsible for military operations in the conflict area. This manual refers to this JFC as the U.S. military area commander.

UNITED STATES SPECIAL OPERATIONS COMMAND

USSOCOM is the unified combatant command for SO, including PSYOP. (See Figure 5-5.) The SECDEF assigns all CONUS-based PSYOP forces to the USCINCSOC. He exercises COCOM of assigned forces through a combination of Service and joint component commanders. USCINCSOC prepares

assigned PSYOP forces to conduct PSYOP supporting U.S. national security interests across the operational continuum. Through the CJCS, and in coordination with the Assistant Secretary of Defense for Special Operations and Low-Intensity Conflict (ASD SO/LIC), he advises the NCA and the NSC

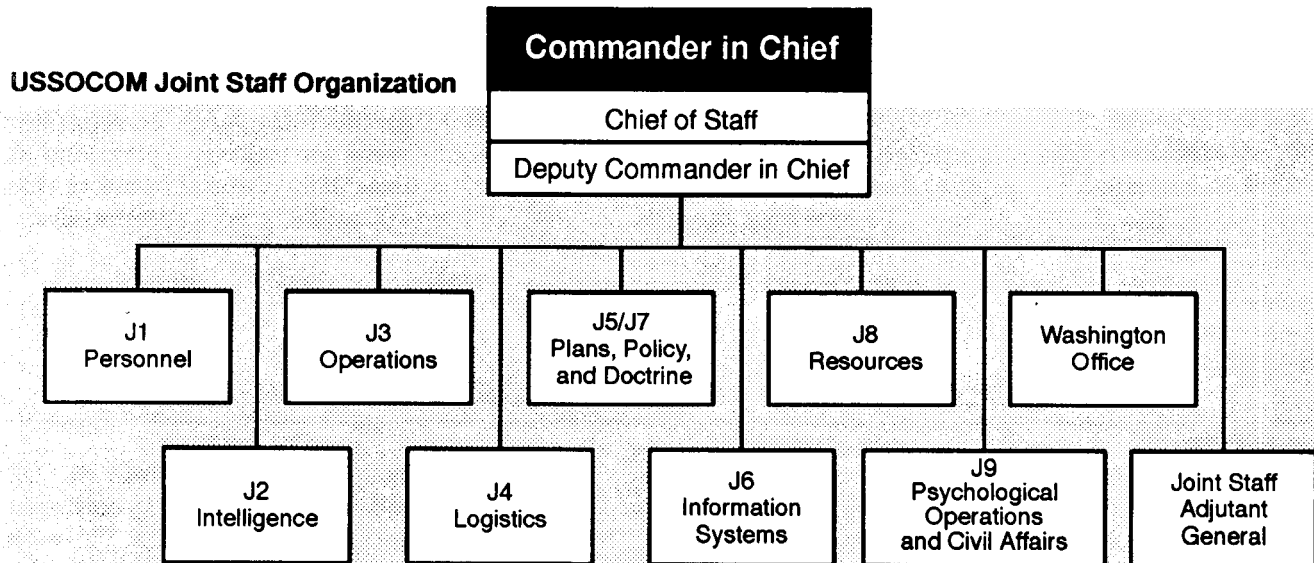
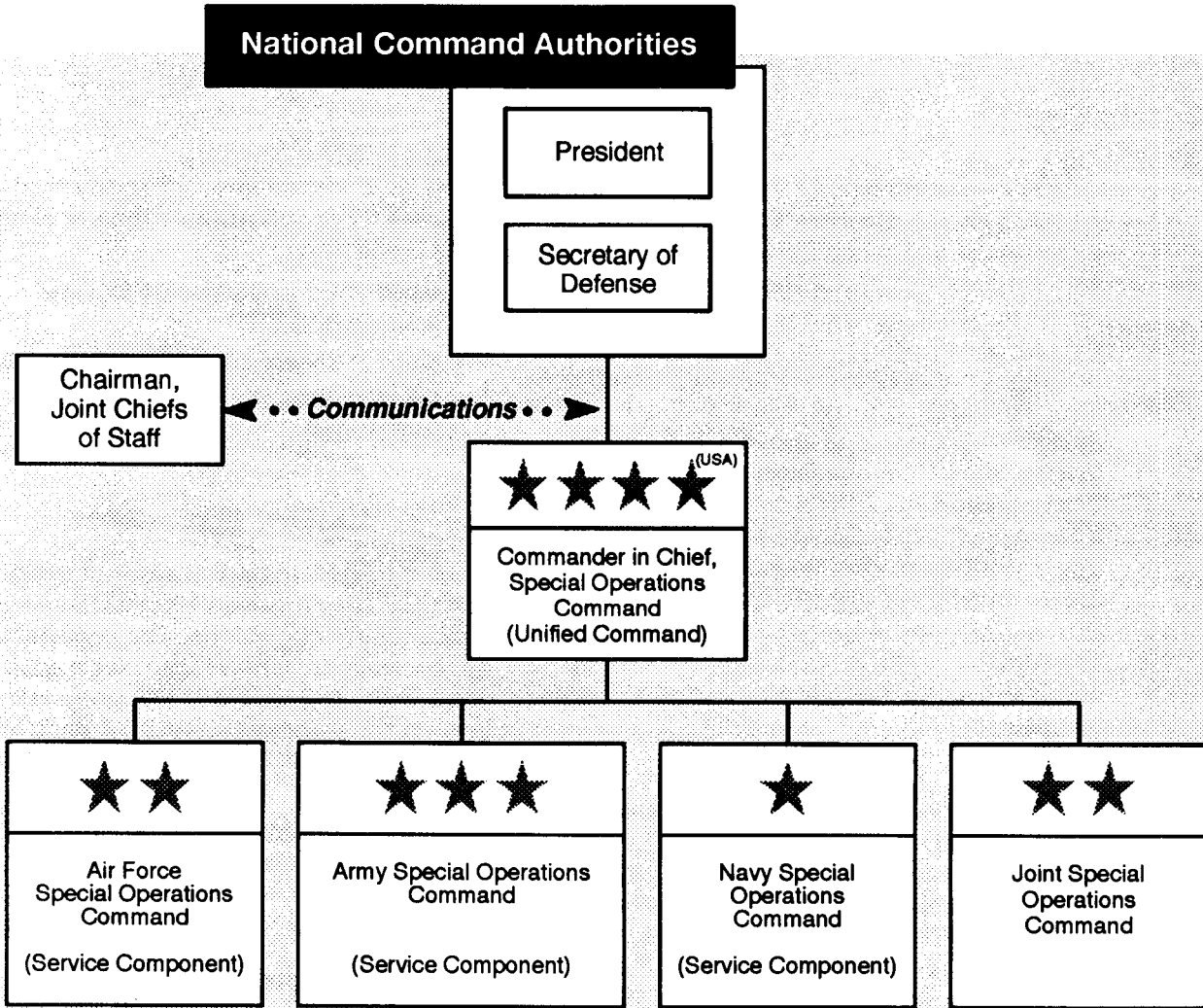

Figure 5-5. USSOCOM organization.

on PSYOP matters. USCINCSOC has no geographic AOR for normal operations. He normally acts as a supporting CINC, providing mission-ready PSYOP forces to regional CINCs for use under their COCOM. The NCA may direct USCINCSOC to command PSYOP forces as a supported CINC or to support a regional CINC. (See Joint Pub 3-05 for a detailed discussion.)

Public law gives USCINCSOC broad functional authority to carry out his responsibility for PSYOP forces. This authority includes-

- Developing joint PSYOP strategy, doctrine, and tactics.
- Educating and training assigned forces.
- Conducting special courses of instruction for officers and NCOs.
- Validating and ranking PSYOP requirements.
- Ensuring assigned forces are mission ready.
- Developing and procuring PSYOP-specific materiel, supplies, and services.
- Assuring the compatibility and interoperability of PSYOP equipment with the PSYOP forces.
- Instituting and implementing procedures for PSYOP intelligence support.
- Monitoring the promotions, assignments, retention, training, and professional military education of PSYOP personnel.
- Monitoring the preparedness of PSYOP forces assigned to other unified combatant commands.

- Combining and proposing PSYOP programs to Major Force Program 11 (MFP 11), a separate military funding program for PSYOP and SO.
- Preparing and executing MFP 11.

DOD staff has several offices that advise the SECDEF in the area of SO and LIC. One of these offices is the ASD SO/LIC. Subject to the direction of the SECDEF, this office provides policy guidance and oversight to govern planning, programming, resourcing, and executing SO and LIC activities.

The Office of the Secretary of Defense (OSD) staff and USCINCSOC will have visibility and control over the use of MFP 11 resources. Additionally, among other responsibilities, the OSD staff, in coordination with the CJCS and USCINCSOC, reviews the procedures by which USCINCSOC receives, plans, and executes NCA taskings.

With the OSD staff, the USCINCSOC has head-of-agency authority. MFP 11 provides visibility and control of the PSYOP forces resource allocation process. The OSD staff and USCINCSOC oversee the DOD PPBS on PSYOP forces. They have the chance to address issues during sessions of the Defense Resources Board.

The USCINCSOC's Washington Office is his command element in the Washington area. This office is USSOCOM's link with the Services, DOD, Congress, and other government and nongovernment agencies for all PSYOP matters.

UNITED STATES ARMY SPECIAL OPERATIONS COMMAND (USASOC)

USASOC (Figure 5-6) is a major Army command (MACOM) and the Army component command of USSOCOM. Its mission is to command, support, and ensure the combat readiness of assigned and attached Army

forces for worldwide use. As a MACOM, it focuses on policy development, management and distribution of resources, and long-range planning, programming, and budgeting of ARSOF. The USASOC commander

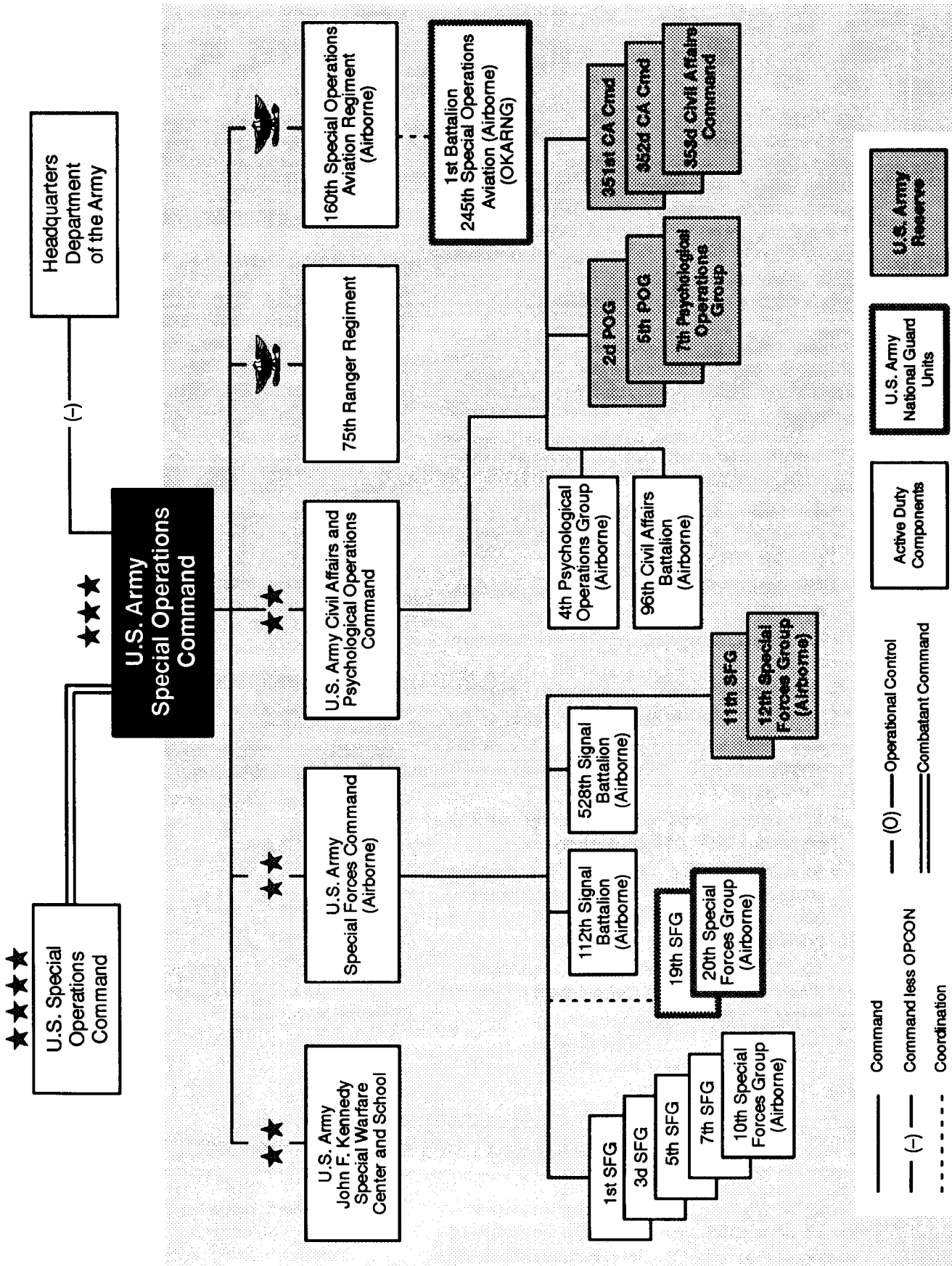

Figure 5-6. USASOC organization.

exercises command of CONUS-based Army AC and RC ARSOF. When directed by USCINCSOC, USASOC provides mission-ready PSYOP forces to the regional combatant command CINCs for use under their COCOM. Specific USASOC functions include—

- Training assigned forces to ensure the highest level of mission readiness consistent with available resources.
- Directing the planning and preparation of assigned ARSOF for contingency and wartime employment.
- Assisting in developing and coordinating joint and Army PSYOP requirements, issues, and activities.
- Assisting in developing joint and Army PSYOP doctrine, organization, institution training, materiel, supplies, and Services.
- Preparing and submitting PSYOP forces program and budget documents.
- Coordinating, monitoring, and preparing forces for support of special activities.
- Making sure assigned forces can support conventional military operations and joint PSYOP in peacetime, conflict, and war.
- Planning and conducting other training, operations, and support, as directed.

UNITED STATES ARMY CIVIL AFFAIRS AND PSYCHOLOGICAL OPERATIONS COMMAND (USACAPOC)

USACAPOC is a major subordinate command of USASOC. Commander, USACAPOC, exercises C² of CONUS-based Army AC and RC PSYOP and CA forces. It monitors the progress of implementing ARSOF policies, plans, and programs by these forces to ensure CA and PSYOP forces are organized,

trained, and equipped to meet their worldwide mission requirements. Upon mobilization, USACAPOC continues to perform its mission and to assist in the mobilization of USAR CA and PSYOP units and individuals, as directed by the USASOC.

THEATER ARMY

The TA is the Army component command of a unified command. (See Figure 5-7.) Regardless of OPCON arrangements within the unified command, the TA remains responsible for certain Service-specific functions, to include—

- Recommending the proper use of assigned Service forces to the CINC.
- Accomplishing assigned operational missions.
- Choosing specific units for assignment to other subordinate forces under the CINC's COCOM.
- Informing the CINC of support and sustainment decisions and changes that affect his operational capability and sustainability.
- Conducting joint training, as directed.
- Developing program and budget requests that follow the CINC's guidance on operational requirements and priorities.
- Informing the CINC of program and budget decisions and changes that affect operational and contingency planning.
- Providing supporting plans with necessary force data to support missions assigned by the CINC.

The TA provides, supports, and sustains assigned U.S. Army forces. If directed, it also

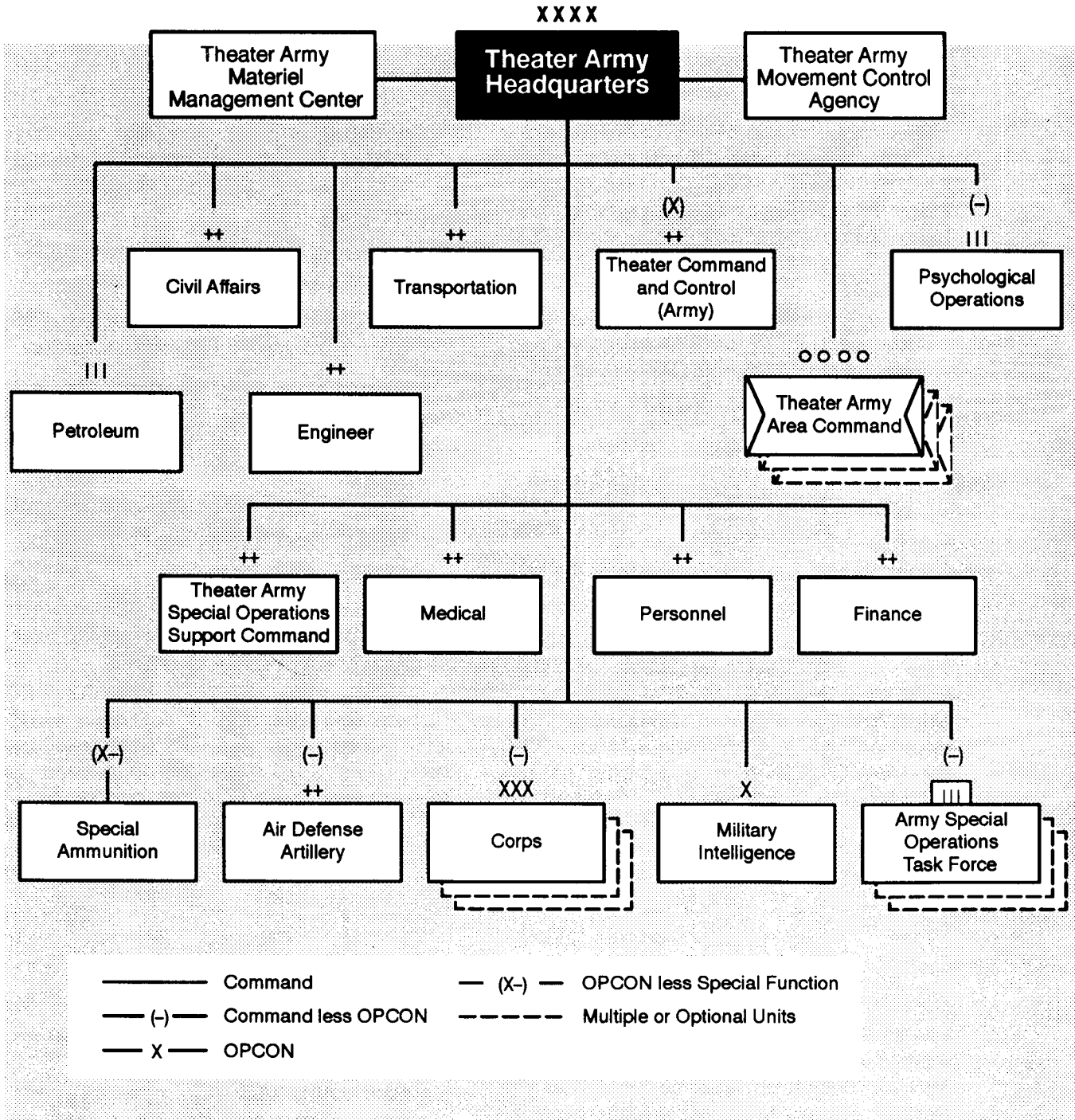

Figure 5-7. Type theater Army organization.

supports and sustains other U.S. Services and allies within a unified command. (See JCS Memo 5100.3.) The CINC may organize his theater differently during peace and war. He considers activities that support peacetime as well as hostilities short of war and war. He may designate a number of subordinate organizational areas to facilitate his operations.

The TA has two types of support commands in the dispersal and logistics area. TAACOMs provide combat service support (CSS) (less medical) and designated combat support (CS) on an area basis in the COMMZ. TA functional commands (finance, personnel, engineer, transportation, and medical) plan, coordinate, and provide functional support to forces. They have no AOR. The TA

functional command that plans and coordinates PSYOP support and sustainment is the theater Army special operations support command (TASOSC), (See Chapter 9 for a detailed discussion of CSS of theater PSYOP).

Two TA agencies are the key to the C² of these organizations. The theater Army materiel management center (TAMMC) provides centralized management of most supply and

maintenance operations. It serves as the primary TA interface with the CONUS sustaining base. In a large theater, each subordinate TAACOM has its own Materiel Management Center (MMC), and the TAMMC is responsible only for TA-controlled items. The theater Army movement control agency (TAMCA) provides theaterwide movement management and control of transportation assets.

THEATER PSYOP

The SECDEF assigns or attaches all required PSYOP forces OCONUS through USSOCOM to the supported regional combatant command CINC. Only the NCA can authorize the transfer of COCOM from one CINC to another. The transfer of COCOM occurs when forces are reassigned. When forces are not reassigned, OPCON passes to the supported CINC. The NCA (through JCS command arrangements) specifies in the deployment order when and to whom COCOM or OPCON passes.

The POTG or a POTF (a task-organized PSYOP battalion operating independently) normally forms the basis for the senior PSYOP headquarters in the theater. With appropriate augmentation, this headquarters normally becomes a joint organization. This joint headquarters is normally referred to as a JPOTG or, in the case of a PSYOP battalion operating independently, a joint psychological operations task force (JPOTF). (See Figures 5-8 and 5-9.)

The JPOTG (or JPOTF) is located with the senior commander in theater. The JPOTG is with the CINC's headquarters during war and the JPOTF with the task force headquarters during a contingency operation. During a smaller contingency operation the JPOTF will be with the commander of the JTF headquarters (a subunified command or a component command in the absence of the CINC). The senior PSYOP commander in

theater supporting the warfighting CINC recommends organizational options to perform the PSYOP mission. The warfighting CINC approves one of the recommended options. These organizational options depend on the situation, mission, and duration of operations. The JPOTG or JPOTF controls all PSYOP. The POTG and POTF control only Army PSYOP.

The JPOTG normally fits into the unified command structure as a functional component command reporting directly to the CINC. The JPOTG normally provides PSYOP augmentation to the J3 division as an integral part of the CINC'S staff. In this case, the JPOTG commander wears two hats-he is the CINC'S senior PSYOP staff officer and is the commander of the JPOTG exercising OPCON overall PSYOP forces in theater. The JPOTF normally functions the same way with a JTF. During peacetime and smaller contingency operations, the AC PSYOP group may only have to provide PSYOP augmentation to the CINC or JTF headquarters.

All PSYOP C² elements are dual tasked as the principal staff member for PSYOP to their supported headquarters.

PSYOP elements depend on their supported elements for routine sustainment. This relationship may be described as attached for administration and logistics (administrative control or command less OPCON). Their mission guidance continues to come through PSYOP channels to the supported unit. The

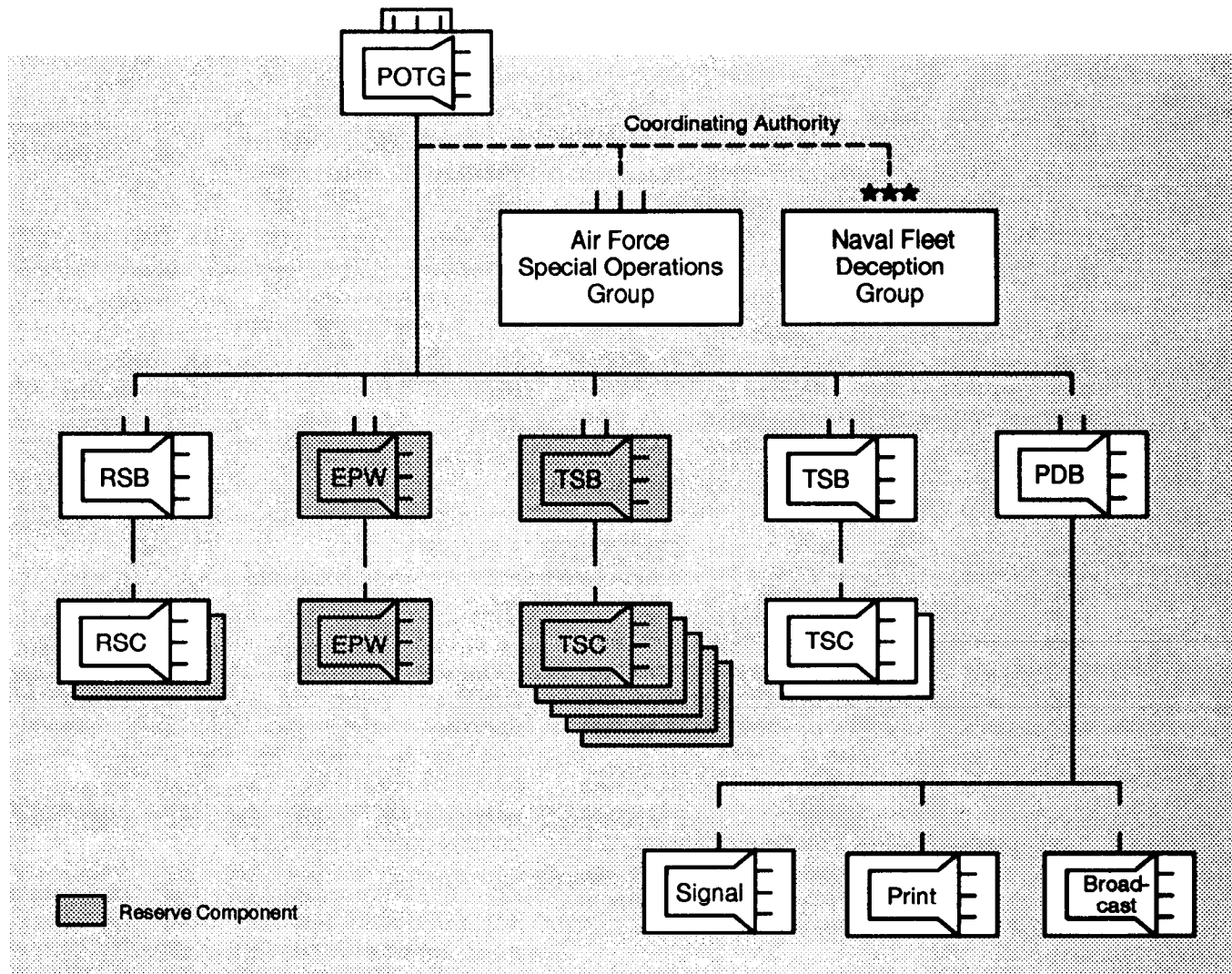

Figure 5-8. A typical JPOTG.

TASOSC ensures PSYOP sustainment requirements are properly planned for and coordinated with TA support elements. The JPOTG or JPOTF will perform this function in the absence of a TASOSC.

Establishment of a JPOTG or JPOTF at the unified combatant command level or senior headquarters level is essential during all major, high-visibility military operations conducted within the CINC's AOR, regardless of scope, duration, or degree of direct participation exercised by the CINC. The psychological impact of military operations conducted by a subordinate unified command or a JTF is never confined to the specific operational area. Rather, it creates a spillover effect that may be felt over large areas of the supported CINC's region and, in some cases, far beyond his geographic

boundaries into an adjacent CINC's AOR. The JPOTG or JPOTF would, at the supported CINC's direction, plan and develop PSYOP campaigns to neutralize or reverse the negative psychological impact in the affected areas. These programs could be coordinated with the adjacent CINC's theaterwide PSYOP campaigns to obtain the same response. The JPOTG or JPOTF C² structure ensures a coordinated PSYOP campaign to support the CINC's theater campaign plan.

The supported CINC's mission and the estimated duration of PSYOP activities influence the senior PSYOP commander's recommendation. Army PSYOP forces support general purpose forces during conventional operations. The remaining PSYOP forces support SOF operations and missions. The senior

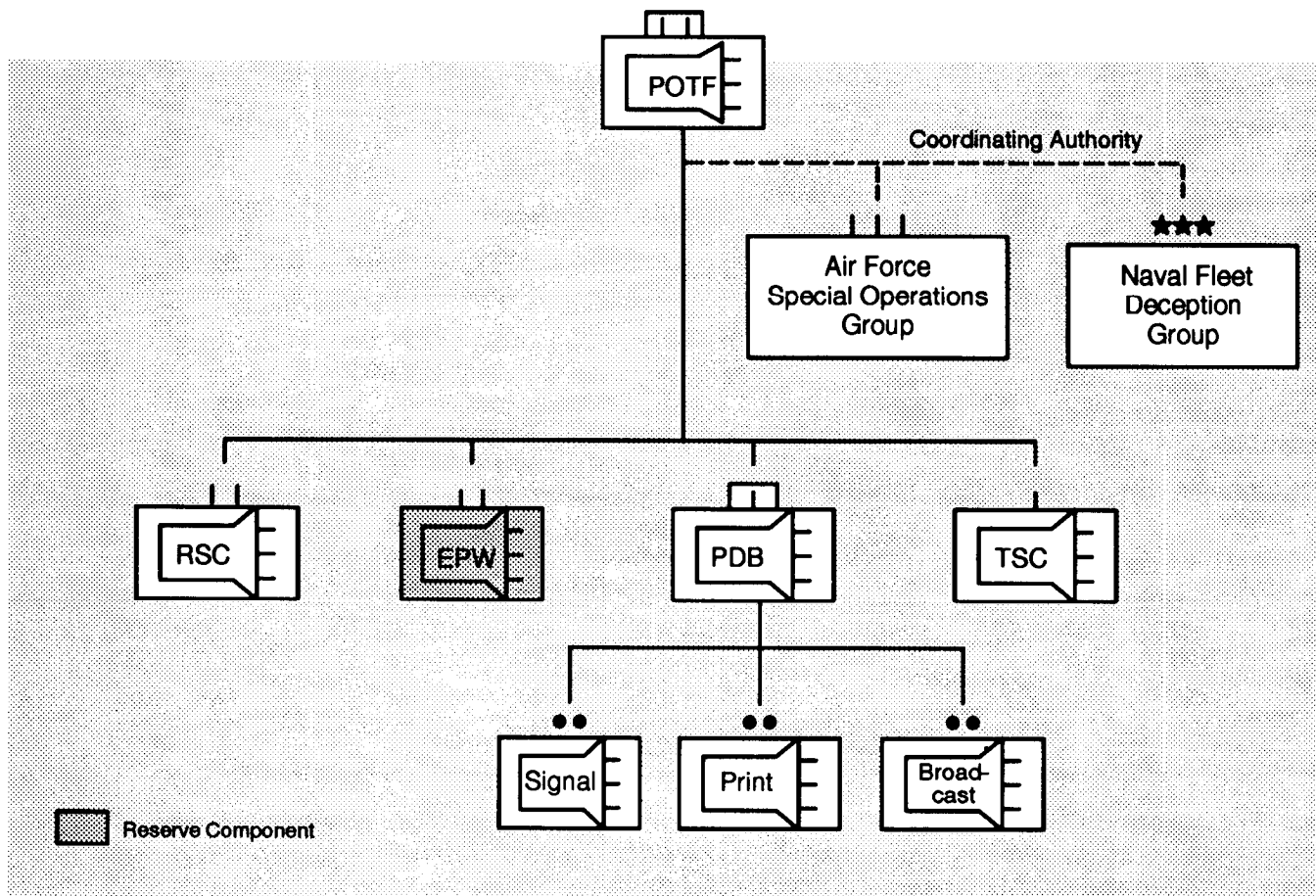

Figure 5-9. A typical JPOTF.

PSYOP commander assigns a liaison team to the SOC and joint special operations task force (JSOTF), if established.

The senior PSYOP commander in the theater, when supporting SO, recommends to the SOC or JSOTF commander the proper use of PSYOP to support SO. During contingencies,

the senior PSYOP commander must analyze the supported CINC's mission and update the applicable PSYOP appendix. He then allocates PSYOP assets to support SO according to the mission, situation, and assets available. The JFC gives the SOC or JSOTF commander authority to accomplish assigned missions and tasks.

DEPLOYMENT

AC PSYOP units receive deployment orders, and as appropriate, designated RC PSYOP units are mobilized and receive deployment orders. The unit moves to a port of embarkation (POE). From there, the PSYOP unit moves by air or sea into the gaining CINC's AOR. At a predetermined point (for example, upon crossing a specified latitude or longitude), COCOM or OPCON is formally passed to the gaining CINC. The gaining TA commander receives the PSYOP unit at the port

of debarkation (POD). The TA commander takes command of the PSYOP unit until it arrives at its operational base and is fully mission capable. The TA commander then passes OPCON to the supported CINC.

The current law governing the transfer of forces is in Title 10, USC, Section 162. This law's intent is to make sure all operational forces in a CINC's AOR are under COCOM of the CINC unless the SECDEF has directed

otherwise. (See Figure 5-10.) Additionally, it requires the military to assign and maintain the unified and specified commands with forces directed by the SECDEF. The Joint Operations Planning and Execution System (JOPEs), Volume IV (a classified document), gives procedures for issuing deployment orders. Under JOPEs, the CJCS can issue a deployment order after the SECDEF's approval to-

- Increase the deployability posture of units.
- Decrease the deployability posture of units.

- Deploy forces.
- Redeploy forces.
- Establish JTFs, activate a JTF headquarters, or appoint the JTF commander.
- Direct any other action that would signal planned U.S. military action or its end in response to a specific crisis, event, or incident. Movement of forces or unit identification codes (UICs) requires a deployment order. However, requests for resupply, sustainment, or nonunit personnel and equipment do not, unless directed by the SECDEF.

LEVELS OF MOBILIZATION

The President and Congress may carry out any of the four levels of mobilization, based on the situation and extent of the emergency.

Selective Mobilization

The first level of mobilization is the Presidential call-up in which the President has the authority to mobilize up to 200,000 soldiers from the RC. This call-up now lasts up to 90 days and may be extended for another 90 days.

Partial Mobilization

When the situation requires more than 200,000 troops, the next level of mobilization

might begin. At this level, Congress or the President can mobilize up to 1 million troops for up to two years.

Full Mobilization

When Congress passes a law or joint resolution declaring war or a national emergency, full mobilization occurs. This level can last for the duration of the war plus six months.

Total Mobilization

This level allows Congress and the President to expand the active armed forces beyond their current limits.

COMMUNICATIONS

Reliable, survivable, and flexible communications are essential for command, control, communications, computers, and intelligence (C⁴I). Army doctrine dictates that communications responsibilities go from "higher to lower," from "supporting to supported," and from "left to right." PSYOP commanders

must comply with these principles. The challenge is interoperability in a joint, combined, or interagency operational environment.

Signal support plans must exist for each type of operation. Commanders and staffs at all levels must understand the capabilities and

Intended Action	Deployment Order Required	SECDEF Approval Required
CINC requests additional forces	Yes	Yes
Deploy liaison elements to allied headquarters	Yes	Yes
Deploy individual personnel and equipment	No*	No*
Resupply, sustainment, non-unit-related personnel/equipment (beans, bullets, etc.)	No	No

*Unless directed by SECDEF (for example, counterdrug operations).

Figure 5-10. Deployment order matrix.

limitations of their organic communications systems to support operational requirements. Deliberate and detailed planning in support of joint, combined, and interagency operations can prevent communications shortfalls. The integration of all available assets is essential to success.

Atmospheric conditions, terrain, the opponent, electronic warfare (EW) efforts, and the nuclear electromagnetic pulse (EMP) may all affect electronic signal equipment. The key to survivability is establishing communications procedures that—

- Provide redundancy of communication systems and capabilities.
- Eliminate unnecessary reports.
- Ensure subordinates know what to do during communications interruptions.
- Limit the use of electronic communications.
- Reduce the use of the most vulnerable means.
- Stress OPSEC and communications security (COMSEC) .

Communications between PSYOP units and sections in the field may be difficult. Poor communications can reduce the efficiency and coordination of the PSYOP effort. To be effective, PSYOP units need secure radios and area communications systems. The internal communications procedures of PSYOP battalions and companies need to be

considered in the development of supported unit field SOPs. They also need their own radio frequency in the division communications net. At a minimum, loudspeaker and liaison teams need secure, high-frequency communications. The internal communications procedures of PSYOP battalions and companies have to be a part of unit field SOPs.

Rapid advancements in electronic communications and information systems have revolutionized communications. Tactical satellites (TACSAT) let senior PSYOP commands communicate with their supported PSYOP agencies. The PSYOP Automated Data System (POADS) and the Special Operations Command Research, Analysis, and Threat Evaluation System (SOCRATES) are available to the PSYOP community.

POADS is an automated data-processing capability that supports the PSYOP community. POADS consists of collection and production management, operations, planning and support, and administrative data bases. With permission, this system may be accessible to WWMCCS. When fully implemented, POADS will allow annexes to various OPLANs, for example, to be more easily updated and disseminated via the communications aspects of the system. The software designs vary between the AC and RC.

See Chapter 8, page 8-6, for a discussion of SOCRATES.

LIAISON

Liaison teams play a key role in PSYOP mission effectiveness. When using liaison teams, commanders must use organic, uncommitted personnel. The senior PSYOP commander in the AO exchanges PSYOP liaison personnel with the supported units,

U.S. nonmilitary agencies (as appropriate), and allied military organizations. The exchange of liaison personnel provides a network of proper mutual support and synchronization. PSYOP personnel at all levels must be ready to assume liaison duties.

Chapter 6

E m p l o y m e n t O f P S Y O P F o r c e s

The senior PSYOP commander in the theater of operations recommends the positioning of PSYOP forces. Mission, terrain, logistics, and the supported unit are considerations when determining where to locate and how to configure the PSYOP units. The senior PSYOP commander must make sure the locations of the subordinate units provide him responsive C² and adequate OPSEC.

PSYOP TASK GROUP

Upon deployment, the POTG considers several factors when determining basing within the theater. These factors determine the most efficient organization to support the unified commander's PSYOP campaign plan. Since the POTG commander serves as the senior PSYOP staff officer to the unified command, the POTG headquarters must be collocated with the CINC's headquarters. This arrangement ensures effective coordination with the unified command staff, the country team, and other government agencies. This

arrangement also makes easier staff coordination for administration, intelligence, and operation and logistics support to the entire POTG. Collocation at the unified command level ensures effective and timely coordination, through command channels, with all supported and supporting component command staffs. It is imperative the POTG establish liaison between the component command staffs, the country team, and other government agencies.

PSYOP DISSEMINATION BATTALION

A deployed POTG requires a PSYOP dissemination battalion and an EPW PSYOP company to support the total PSYOP effort. This battalion provides mass production and dissemination of printed and broadcast media across the operational area. It also provides strategic and operational communications assets that support the POTG.

Print Company

The PSYOP dissemination battalion's print junction should be collocated with the organization responsible for the dissemination of the majority of the printed media. Air dissemination will most likely be the means used to deliver printed media. These air

assets will be the Air Force or Army aviation. The print company, at a minimum, should therefore be based at the supporting airfield. Such basing will ensure proper base support for extensive print operations while providing efficient coordination for air mission support.

Broadcast Company

The broadcast company provides radio and TV broadcasts supporting the PSYOP campaign. Its location is where it can best support this mission. Basing considerations

include broadcast footprints, range, and retransmission operations as well as studio support functions. Finally, planners need to consider interoperation between the broadcast company and the EC- 130 VOLANT SOLO platform.

Signal Company

The signal company provides signal support to the entire POTG/POTF deployed across the theater. Accordingly, its location allows for effective POTG/POTF command, control, and support functions.

EPW PSYOP COMPANY

This company provides PSYOP support to EAC EPW operations as well as PSYOP-specific intelligence to the POTG/POTF. Therefore, it should be collocated with the

EAC or corps EPW operations to allow interface with the company's strategic communications capability.

REGIONAL SUPPORT BATTALION AND REGIONAL SUPPORT COMPANY

The RSB's sole mission is to provide region-specific product development support for the theater during peace, hostilities short of war, and war. The RSB or RSC serves as the POTF headquarters for JTF contingencies. Such employment allows not only the centralization of product development and its approval

functions within the theater but also continual coordination between the combined PSYOP effort and the RSB or RSC. Therefore, to ensure effective product development supporting the overall PSYOP effort, the RSB should be collocated with the POTG at the senior headquarters in the theater.

TACTICAL SUPPORT BATTALION AND TACTICAL SUPPORT COMPANY

The TSB commander serves as the senior PSYOP staff officer for the corps or the Marine Expeditionary Force (MEF) commander. The battalion provides tactical support and limited product development

to the corps and its subordinate elements. Accordingly, it should be collocated with the corps or MEF, and the TSC and its subordinate elements should be located at division and below.

193d SPECIAL OPERATIONS GROUP

The 193d Special Operations Group of the Pennsylvania Air National Guard provides the EC-130 VOLANT SOLO, the sole airborne broadcast dissemination capability within DOD. Due to the centralized development and approval of all product in the theater, elements of the 193d Special Operations Group must collocate with the POTG.

Further, planners consider basing VOLANT SOLO flight operations in the same location as the POTG. If such basing is not possible, there must be dedicated air support for daily transfer of taped TV and radio PSYOP programs between the POTG/POTF and the EC-130 air operations base.

PSYOP TASK FORCE

If the contingency is less than a theater support operation, the POTF will most likely represent the senior PSYOP headquarters in the theater supporting a JTF, and the same planning considerations apply as for the

POTG. However if the approval authority has not been delegated to the JTF, the POTF must then maintain active liaison with the headquarters exercising PSYOP approval authority.

Chapter 7

Mission Planning and Targeting

Mission planning is the first step in preparing for war. It guides the PSYOP analysis of the operational area by focusing on the operations most likely to be executed. It draws together, in priority, the psychological information needed to build the intelligence data base. PSYOP commanders and planners at all echelons need to be aware of the breadth and scope of mission planning. This chapter describes how to identify PSYOP missions and how PSYOP units do their planning to perform those missions.

MISSION

The PSYOP unit's mission comes from the supported unit's mission. Thus, PSYOP mission planning focuses on how to provide the most effective support to the supported unit. The senior PSYOP commander in the theater must know which assigned, attached, and indigenous forces and equipment are available. He must then focus on using those assets toward target audiences.

Upon receipt of the mission from the commander, the PSYOP unit's S2 requests background intelligence from every available source. He queries U.S. assets, non-DOD assets, HN assets, and the supported unit's assets. He uses the data obtained from these sources to develop the information required to conduct effective PSYOP. To satisfy additional PSYOP intelligence needs, the S2 also gets current versions of BPSs, SPSs, and SPAS pertaining to the target audience. (See Chapter 8 for more information on intelligence support to PSYOP.)

PSYOP may be an integral part of an overall military operation or an independent entity. As a part of SOF in peacetime, PSYOP may support special or conventional operations throughout the operational continuum. PSYOP commanders and planners must remember that the theater CINC may choose one of several command relationship options. (See Chapter 5 for more information on these command relationships.) Regardless of mission derivation, PSYOP personnel make sure that mission planning and targeting are accurate. During conventional or special operations, the senior PSYOP commander is the PSYOP special staff officer for the CINC.

PSYOP commanders and coordinators conduct deliberate and time-sensitive mission planning and targeting. Their missions are a result of the joint strategic planning process. As such, they must reflect current national security policy and strategy.

JOINT STRATEGIC PLANNING PROCESS

At the beginning of a new administration and when required after that, the President examines the national security situation. He directs the SECDEF to study national security and make recommendations on defense strategies, forces, and capabilities. The SECDEF, in turn, directs the CJCS to assess the military and recommend military strategy. The Joint Strategic Planning System (JSPS) is the means by which the CJCS develops supporting military advice to the NCA. (See Figure 7- 1.) The biennial National Military Strategy Document (NMSD) is the JSPS product that provides formal CJCS advice to the NCA. It presents the national military strategy and force structure. After receiving and reviewing the NMSD, the SECDEF makes strategy recommendations to the President. The President makes his decision, which the SECDEF incorporates into DPO.

The DPG is the basic DOD strategic plan. It provides overall direction for development of national military strategy, force planning, and DOD participation in national security policy formulation. It establishes broad goals, priorities, and 15-year objectives that focus Service programs toward a balanced, efficient, and cost-effective national military capability. Included in the DPO is the basic defense policy for PSYOP.

Based on the DPO, current intelligence, and available capabilities, the WCS directs the Joint Staff to prepare the JSCP. The JSCP provides short-term (2-year) strategic guidance to the CINCS and Service chiefs. It synchronizes military deliberate planning with the budget cycle. The JSCP assigns tasks and apportions major combat forces and strategic transportation. It also directs the CINCS to develop plans to support specific national security goals. Some functional annexes apportion limited crucial strategic resources other than major combat forces and strategic transportation. These annexes also amplify task assignments and provide additional planning guidance. One function of the PSYOP branch (J33) of the J3, JCS, is to prepare an annex to the JSCP. This annex (Annex D-Psychological Operations) integrates PSYOP into the joint military decision-making process. It also sets forth the tasks and responsibilities of unified and specified commands toward PSYOP. In unified commands, the unified commanders have overall responsibility. However, the CINC's J3 PSYOP staff officers actually carry out PSYOP planning and activities. In specified commands, the PSYOP staff officers do likewise.

THEATER STRATEGY

The theater CINC refines broad national or alliance strategic guidance into a theater military strategy. The theater strategy outlines broad concepts to deal with the diverse situations identified in the theater estimate. It provides for the deployment, employment, and sustainment of U. S., allied, and friendly forces. Its aim is to achieve

national and alliance strategic objectives. (See Joint Pub 3-0 for a detailed discussion of theater military strategy.)

To be effective, the theater CINC must have adequate resources. When the theater CINC identifies shortfalls in capabilities, he acts through the JSPS and the DOD PPBS to correct them.

CAMPAIGN PLANNING

The theater campaign plan is the operational extension of the CINC's theater strategy. A

campaign is a phased series of major operations along an intended line of action to

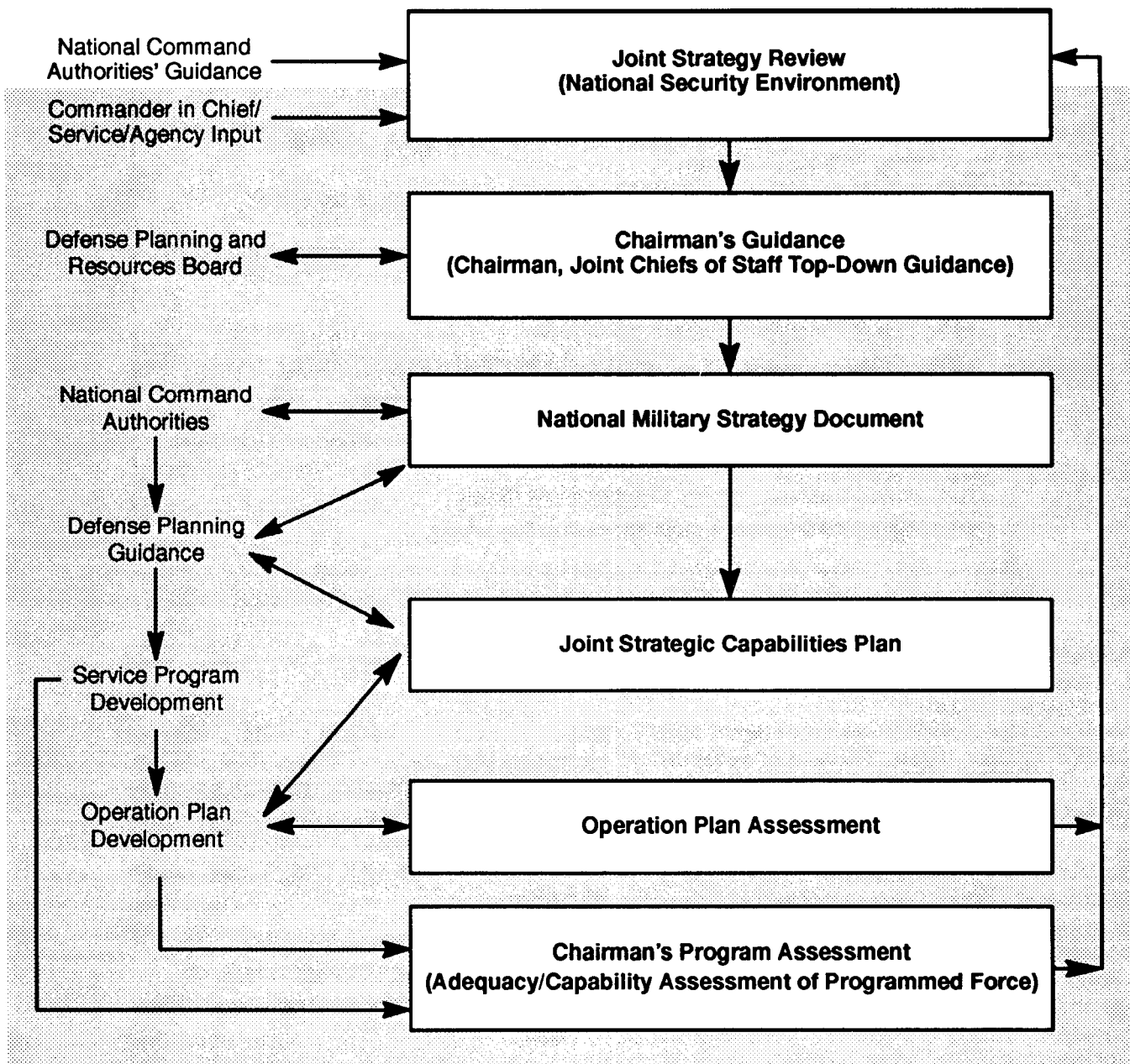

Figure 7-1. Joint Strategic Planning System.

attain strategic goals. The effect of these operations creates the operational advantage, or leverage, that makes the hostile power's position untenable. Figure 7-2 lists the tenets that characterize campaign plans. (See Joint Pubs 3-0, 3-07, and 5-0 for a detailed discussion of campaign planning.)

NOTE: Do not confuse the theater campaign plan with the PSYOP campaign plan.

A key feature of the theater campaign is the theater CINC's authoritative direction and

synchronization of land, air, maritime, and psychological operations throughout a theater of war (or area of conflict). Only one theater campaign can exist, and the theater CINC is responsible for its design and execution. The theater campaign integrates deployment, employment, and sustainment into a coherent whole. In large theaters of war, major operations may occur along more than one line of action. In this case, the theater CINC may establish theaters of operations to conduct subordinate campaigns along each line of action. The aim of

- Provide broad concepts of operations and sustainment (the basis for all other planning) to achieve strategic military objectives in a theater of war or a theater of operations.
- Provide an orderly schedule of strategic military decisions; display the commander's vision and intent.
- Synchronize air, land, maritime, and special operations into a cohesive military effort.
- Specify what constitutes military success and how the enemy is to be defeated.
- Orient on the enemy's center of gravity.
- Phase a series of related major operations.
- Provide a general plan for the entire campaign and a specific plan for the campaign's first phase.
- Compose subordinate forces.
- Establish command and support relationships.
- Provide operational direction to subordinate forces.
- Identify the commander's main and supporting efforts.

Figure 7-2. Campaign plan tenets.

theater campaigns is to attain national and alliance strategic goals. The aim of subordinate campaigns is to achieve theater operational goals.

The theater campaign plan gives subordinate commanders broad operational and sustainment concepts to achieve the CINC's theater strategy. The campaign plan describes the commander's vision of how the operation will unfold. It explains how he intends to sequence military actions to a well-defined conclusion that achieves strategic goals. It clearly defines the first phase of the campaign and what constitutes military success at the end of the campaign. The mid phases of the campaign plan are less clearly defined. However, this portion of the plan must contain contingencies that address two options

- *Branches.* Branches shift lines of action and accept or decline battle in response to a change in the situation.
- *Sequels.* Sequels exploit successor minimize losses depending on the outcome of battles.

Even when the theater CINC divides the entire theater of war into subordinate theaters of operations and does not directly control

major operations, he still needs a theater campaign plan. He uses this plan to allocate resources, synchronize the subordinate campaigns of the theaters of operations, and provide operational direction to those forces directly under his COCOM. These forces include—

- Strategic reserves.
- SOF performing strategic missions.
- Forces conducting strategic-level deception.

Each subordinate theater of operations commander develops the theater CINC's broad strategic direction into specific operational guidance to control joint military operations directly. He uses his subordinate campaign plan to—

- Set the operational tempo of his command.
- Provide direction for the design and execution of major operations by his subordinate force commanders.
- Compose subordinate forces and designate command relationships.
- Identify and assign operational goals to subordinate force commanders.
- Identify the main and supporting efforts.

SOC CAMPAIGN PLANNING

PSYOP commanders and planners must understand the SOC campaign planning process, especially when PSYOP support SO and the supported headquarters is a SOC or Army special operations command (ARSOC). The SOC integrates all PSYOP and psychological actions that support SO missions.

Theater SO Planning

The theater CINC's special staff officer for SO prepares the SO appendix to the theater campaign plan. This appendix performs four functions for theater SOF. It—

- Provides intent.
- Establishes priorities.
- Identifies future operations.
- Tasks component commanders.

Provides Intent

The appendix provides the theater CINC's SOF employment concept. It describes what he wants theater SOF to achieve, how he intends to use them, and why he wants to use them that way. The CINC's SOF employment concept transforms broad national, alliance, and theater strategic guidance into operational and sustainment concepts. His concept permits subordinate SOF commanders to take the initiative in the absence or interruption of further guidance.

Establishes Priorities

The appendix sets the order in and degree to which the CINC plans and conducts SO. These priorities must be consistent with the overall intent.

Identifies Future operations

The appendix identifies future SO the CINC anticipates as part of future campaigns and

major operations. It serves as a guideline for long-range SO planning. Future SO should flow logically from current operations.

Tasks Component Commanders

The appendix tasks the SOC commander to perform operational planning. It tasks the Service component commanders to prepare, provide, support, and sustain theater SOF.

SOC Planning

Based on the CINC's SOF employment concept, the SOC commander determines his own priorities and intentions. He and his staff prepare subordinate campaign plans, OPIANs, and CONPLANs. These plans develop the theater CINC's SOF employment concept into a sequence of integrated SO that support theater campaign plans for war or protracted conflict.

During this campaign planning process, the SOC commander must maintain a theater-wide perspective. He must fully understand the theater CINC's concept and the way each component commander intends to carry out his aspect of the theater campaign. He must identify and anticipate theater requirements that SOF can address. These requirements normally include a theater reserve of SOF elements for unanticipated, time-sensitive missions. Once the SOC commander identifies theater strategic requirements, he develops and recommends SO that satisfy them. He then allocates SOF resources to those operations. He also manages by exception the sustainment of theater SOF to make sure they remain mission-capable. During sustained operations, the SOC commander and his staff use changes in the CINC'S intent, situation reports, PSYOP reports (PSYREPS) from subordinate units, and their own estimates to revise the SOC commander's priorities and intentions, as required.

JOINT OPERATIONS PLANNING AND EXECUTION PROCESS

The JOPES is the DOD-directed, JCS-specified system to conduct joint planning. The amount of time available determines which of two planning methods to use.

predicted conditions and the resources apportioned for planning purposes. Depending on the level of detail included, the product is either an OPLAN or a CONPLAN. (See Joint Pub 5-02.1 for information on deliberate planning procedures.)

Deliberate Planning Process

Joint planners use the deliberate planning process (Figure 7-3) when time permits (18 to 24 months). Deliberate planning develops a plan of military action based on

Time-Sensitive Planning Process

Joint planners use time-sensitive procedures or crisis action procedures (CAP) during crises when combat action is

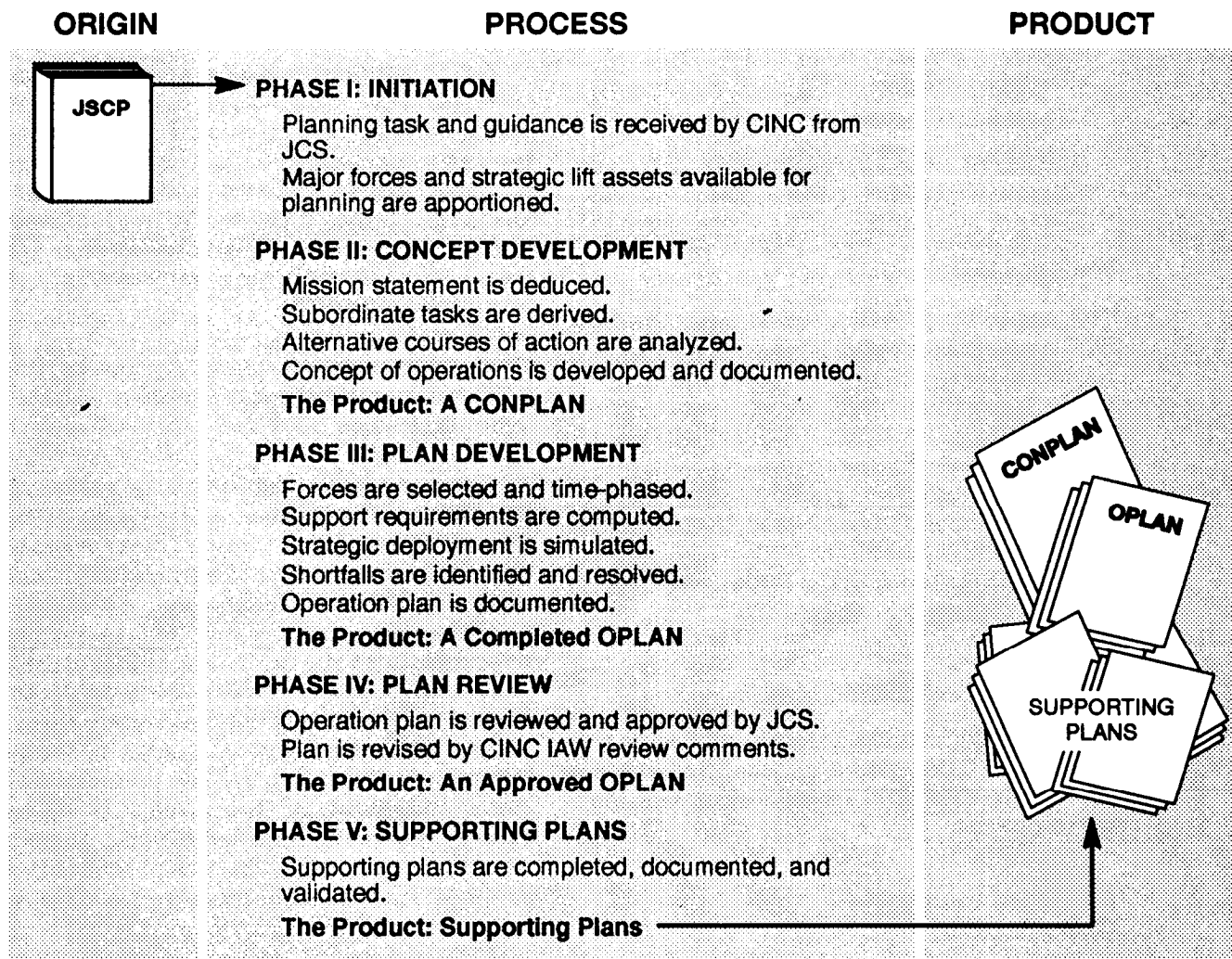

Figure 7-3. The deliberate planning process.

	Phase I Situation Development	Phase II Crisis Assessment	Phase III Course of Action Development	Phase IV Course of Action Selection	Phase V Execution Planning	Phase VI Execution
EVENT	Event occurs with possible national security implications.	CJCS receives CINC's report/assessment.	CJCS publishes warning order.	CJCS presents refined and prioritized COAs to NCA.	CINC receives alert order or planning order.	NCA decide to execute OPORD.
ACTION	CINC/CJCS monitors world situation. CINC/CJCS recognizes problems. CINC submits assessment.	CINC increases awareness. CINC increases reporting. JCS assess situation. JCS advise on possible military action. NCA/CJCS evaluates situation.	CINC develops COAs. JCS evaluate COAs. USTRANSCOM creates/modifies data base. CINC assigns tasks to subordinates by evaluation request message. CINC reviews evaluation response messages. USTRANSCOM prepares deployment estimates.	CJCS gives military advice to NCA. CJCS may publish planning order to begin execution planning before formal selection of COA by NCA.	CINC identifies movement requirements. USTRANSCOM adjusts data base. CINC identifies and assigns tasks to units. CINC converts COA into OPORDs. CINC/CJCS resolves shortfalls and limitations. JCS monitor OPORD development.	CJCS publishes execute order by authority and direction of SECDEF. CINC executes OPORD. USTRANSCOM maintains data base. USTRANSCOM reports execution status.
OUTCOME	CINC/CJCS determines that event may have national implications. CJCS reports event to NCA.	NCA decide to develop military COA.	CINC submits commander's estimate with recommended COA. JCS review CINC's estimate.	NCA select COA. CJCS publishes alert order to announce COA selected by NCA.	CINC publishes OPORD.	Crisis resolved.

Figure 7-4. The time-sensitive planning process.

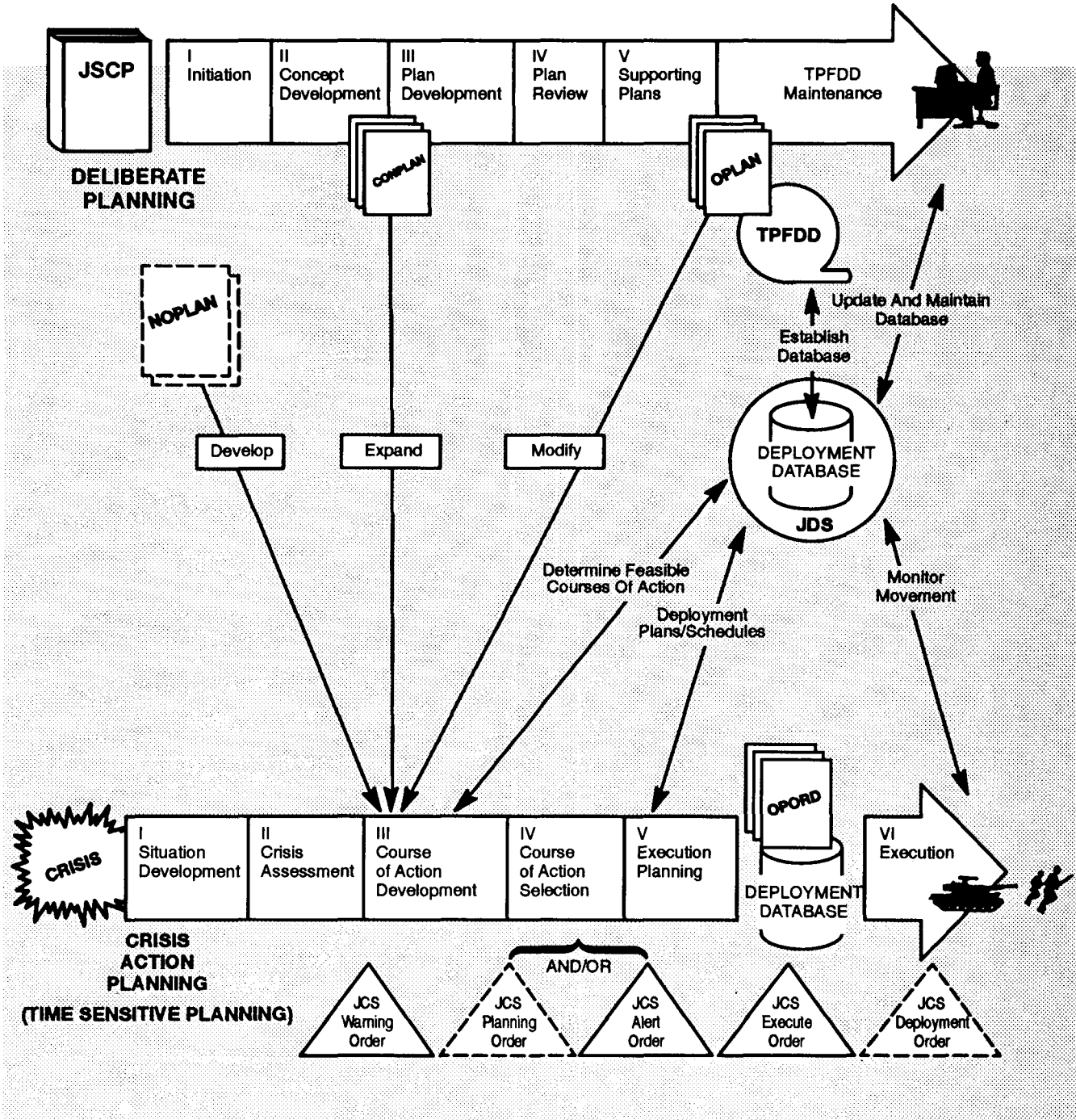

Figure 7-5. Joint planning summary.

imminent (Figure 7-4). Operations Desert Shield and Desert Storm, for example, employed CAP. The time-sensitive process parallels that of deliberate planning. This process is more flexible and responsive to the demands of rapidly changing events. The time-sensitive planning process and the deliberate planning process are illustrated in Figure 7-5.

Time-sensitive planning develops an OPORD based on actual conditions and the resources allocated for execution. For JSCP-addressed contingencies, planners can change an OPLAN or expand a CONPLAN to produce an OPORD. In a no-plan situation, they must develop COAS, a concept of operations, and a deployment database. (See Joint Pub 5-02.4 for information on CAP.)

Five products result from time-sensitive planning:

- Warning order.
- Planning order.
- Alert order.
- Execute order.
- Deployment order.

Warning Order

This order provides initial guidance and requests recommended COAs to meet the situation. It describes the situation and establishes command relationships. It states mission, goals, and assumptions and refers to applicable OPLANS and CONPLANS. It also allocates resources and provides other planning guidance.

Planning Order

This order updates earlier guidance contained in the warning order. It is issued before the NCA authorize execution planning for a selected military COA.

Alert Order

This order announces an NCA decision to authorize execution planning for a selected

military COA. It directs development of the selected military COA into an OPORD.

Execute Order

This order announces an NCA decision to execute a military COA. In a rapidly developing crisis, the execution order may be the first printed communication generated by the CJCS.

Deployment Order

While not formally part of JOPES, this order announces an NCA decision to transfer forces between CINCs. No military unit may deploy or redeploy from one AOR to another AOR without an NCA-approved deployment order. When the transfer of forces between CINCs is permanent, they are normally reassigned. The gaining CINC exercises COCOM of the newly assigned forces. (Refer to Chapter 5 for command relationships.) When the transfer of forces between CINCs is temporary, they are normally attached. The gaining CINC exercises OPCON of the attached forces; the parent CINC retains COCOM less OPCON.

JOINT SO TARGETING PROCESS

Theater campaign planning drives the joint SO targeting process (Figure 7-6), which in turn drives SO mission planning.

The CINC establishes a joint target board (JTB) to direct the theater targeting process, including SO targeting. The board consists of members of the CINC'S staff and representatives of each subordinate command. In regard to SOF, the JTB-

- Establishes SO targeting goals and priorities based on the CINC'S SO targeting guidance and concept of SOF employment.
- Receives, consolidates, deconflicts, and establishes priorities for SO target

nominations from subordinate force commanders and supported allied force commanders.

- Tasks the SOC to assess, plan, and conduct the mission.
- Determines support requirements and tasks the proper agencies to support the mission.
- Tasks the Services' intelligence production agencies (IPAs), through their respective components, to support the targeting process.

The SOC commander makes sure PSYOP are a part of the joint SO targeting process.

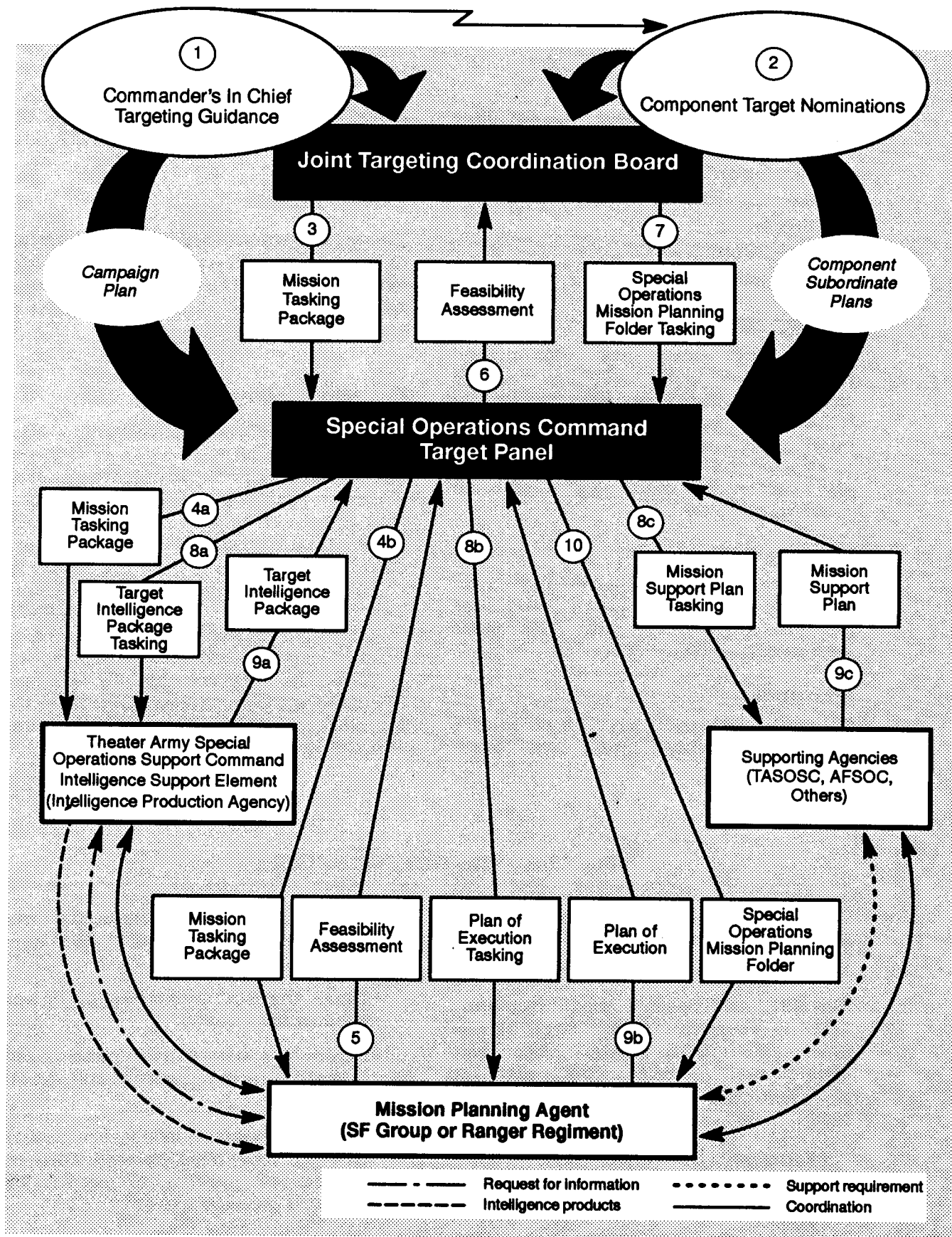

Figure 7-6. Joint SO targeting process.

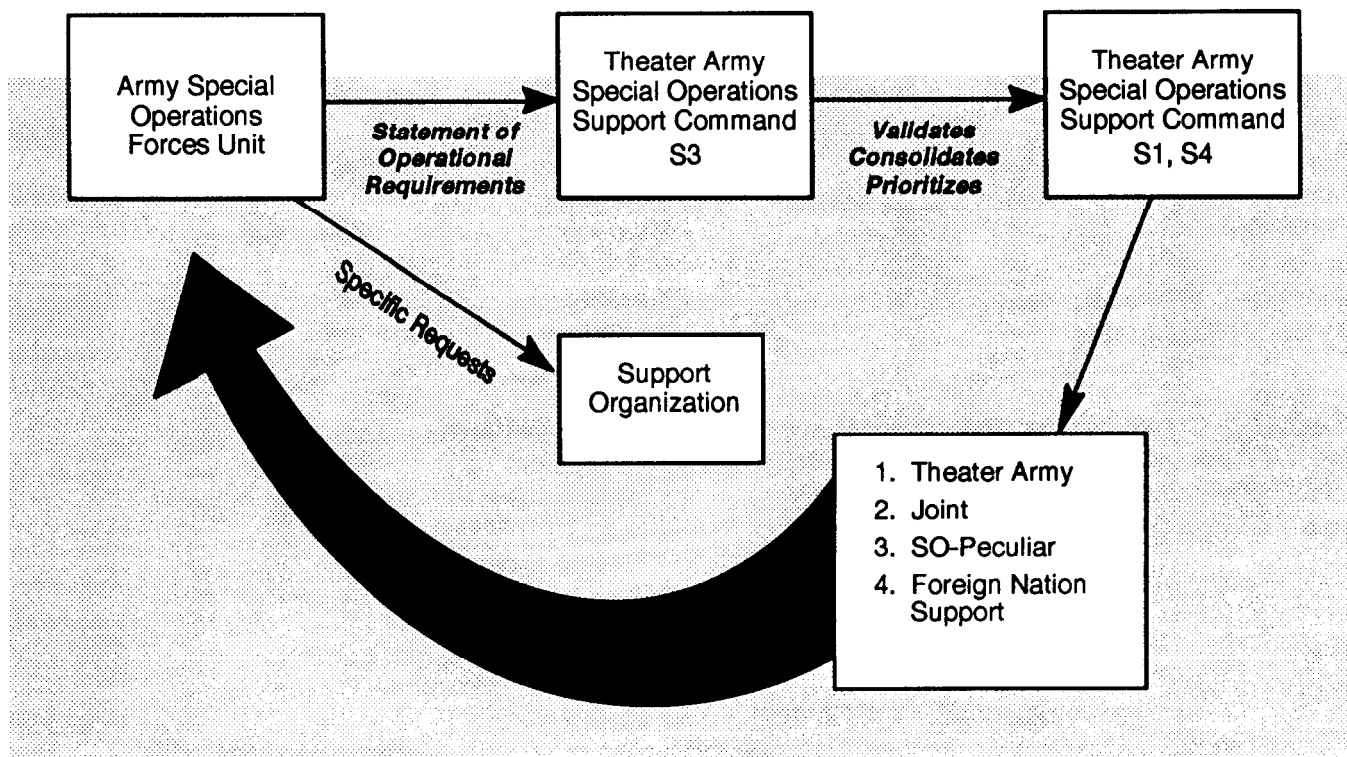

Figure 7-7. ARSOF support and sustainment process.

ASSIGNMENT OF MISSIONS AND OPERATIONAL AREAS

The SOC commander selects AOS and assigns missions for SOF on the basis of the joint targeting process. Missions range from a specific task to a broad, continuing mission

order. For example, the mission may be to attack a point target or to conduct UW in a specified JSOA.

SUPPORT AND SUSTAINMENT PLANNING PROCESS

Once an ARSOF commander receives the SOC mission letter, his staff prepares a statement of operational requirements (SOR). The SOR identifies and consolidates in priority all unit needs that exceed organic capabilities. A complete SOR addresses all aspects of CS and CSS in detail, including—

- Logistics.
- Personnel service support (PSS).
- Health service support.
- Intelligence, OPSEC, and CI support.
- Base defense, including NBC defense, obscurants, and air defense coverage.
- Military police (MP) support.
- Signal support (including frequency management), COMSEC requirements, and access to the theater communications system (TCS) and defense communications system (DCS).
- General aviation support.
- Engineer support, including real estate, real property maintenance activities, base development, and construction of training and rehearsal sites.
- Support of sustainment training of uncommitted SF teams.
- CA and PSYOP support.

The ARSOF unit S3 forwards the SOR to the TASOSC director of plans and operations (DPO) for action (Figure 7-7). Based on guidance from the SOC, the TASOSC DPO prioritizes, validates, and consolidates all theater ARSOF SORS.

The TASOSC commander and his staff are the TA's executive agents for SOF. They plan and coordinate with the proper theater and TA organizations to make sure all

mission-essential needs can be met by a combination of—

- Earmarking TA resources for support of or attachment to ARSOF.
- Establishing and maintaining in-theater operational project stocks.
- Arranging interservice support agreements.
- Planning for accompanying and follow-on supplies.
- Arranging for foreign nation support (FNS).

DELIBERATE MISSION PLANNING

Commanders establish and maintain good working relationships with their supporting PSYOP commanders. They establish relationships as early as possible to ensure the consideration of the PSYOP efforts in the planning process. Additionally, PSYOP commanders must be proactive rather than reactive by developing PSYOP plans for each contingency plan.

Detailed mission planning is vital to the operational element's survival and the mission's success. Based on the SOC commander's or the supported general purpose forces commander's mission tasking package (MTP), mission letters, and other mission guidance, subordinate PSYOP commanders conduct their own deliberate mission planning process. The objective of this process is to develop a comprehensive plan with contingency options. PSYOP commanders cannot tie themselves to a rigid plan. They must anticipate the unexpected and be able to change their plans, as required, to achieve their higher commander's intent.

Deliberate planning is the process followed IAW JOPES, Volume I, Deliberate Planning Procedures. During this process, the PSYOP staff officer develops the PSYOP annex or appendix and integrates PSYOP into the plan. The level of the OPLAN or OPORD

dictates whether the PSYOP staff officer develops a PSYOP annex or appendix. If the operations portion of an OPLAN is an annex to the basic plan, the PSYOP staff officer prepares a PSYOP appendix to the OPLAN's operations annex.

Based on the deliberate mission planning process, PSYOP commanders give their subordinate commanders mission letters. These mission letters focus on PSYOP mission planning and training efforts before commitment.

A PSYOP operational element's organization, training, and equipment vary with the actual mission. During mission planning, the PSYOP commander must consider—

- The operational environment, including threats to the PSYOP units in the AO.
- The mode of employment (for example, civil actions, helicopter-supported leaflet dissemination operations, engineer operations).
- The scope and duration of the operation.
- The availability of indigenous support mechanisms.
- The communications needs (for example, time sensitivity of information) and means.

- The force protection needs, including NBC defense and intelligence and security countermeasures.
- The collection means (for example, visual observation or photography).
- The ROE.
- Cover and deception.

Deliberate PSYOP targeting and mission planning may require days or weeks to perform an adequate PSYOP analysis and to

prepare for commitment into remote or denied territory. The operational element must gain a thorough knowledge of its AO. Its members must understand the political, social, economic, and military situation in the AO. They must know the ethnic groups, customs, taboos, religions, and other essential data about the local populace that could affect mission execution. Such knowledge comes from an intensive study of the area before commitment. BPSs, SPSs, and SPAS are important sources in this respect.

TIME-SENSITIVE PLANNING

Time-sensitive planning is an organized, systematic approach to crisis situation planning. It occurs when a situation does not allow enough time for the normal deliberate planning sequence. This factor is significant because mission success largely depends on the quality of mission preparation.

Under time-sensitive conditions, the PSYOP staff officer must quickly analyze the situation and provide input on the PSYOP situation using the proper operational report.

Volume IV of JOPES (a classified document) covers the time-sensitive planning process in detail. The steps normally occur in less than 24 hours in a time-sensitive situation for which no previous plan exists.

The hallmark of PSYOP planning is centralization. The senior PSYOP commander's staff develops and coordinates the theater's PSYOP campaign to ensure consistency and continuity. Experience has repeatedly proved that the people who will conduct the mission must be involved in the planning process from the beginning. PSYOP personnel routinely conduct joint planning on a face-to-face basis.

When time and other resources permit, PSYOP personnel use an interactive planning and rehearsal process. Through this process, they refine and validate their planning and build cohesion among all elements executing and supporting the mission. The high point of this process is a full-scale dress rehearsal in real time, including all the idle periods. A real-time dress rehearsal teaches the force how to manage its time. It also indicates the condition soldiers will be in after idle periods. If a full-scale dress rehearsal is impossible, the force still rehearses all critical events in real time. Rehearsals are especially important before conducting loudspeaker operations.

There may not be enough time for normal preparation. In that case, the PSYOP commander determines the minimum essential preparation tasks and changes preparation procedures to complete the tasks. The commander informs the general purpose force, SOC, or JSOTF commander when he cannot complete minimum essential preparation tasks without an unacceptable degree of risk of mission failure.

During an operation's mission execution phase, PSYOP units use conventional troop-leading procedures to plan and conduct tactical combat operations such as loudspeaker operations.

PLANNING CONSIDERATIONS

Planning Stages

PSYOP planning has three basic stages:

- Assessing the situation to weigh PSYOP uses.
- Planning PSYOP plans.
- Executing and monitoring approved PSYOP plans.

Assessing the Situation to Weigh PSYOP Uses

The assessment may be a part of the commander's estimate or an independent planning action. In this stage, planners identify foreign groups that can affect the achievement of U.S. goals or a commander's mission. They evaluate the attitudes and behavior of each target group and determine desired behavior. Planners further assess a target group's susceptibility to U.S. PSYOP actions. They also assess U.S. capabilities to execute specific PSYOP actions and present possible COAs to proper decision makers.

Planning PSYOP Plans

PSYOP planning requires a thorough evaluation of foreign groups' psychological profiles and sources of information that can influence those groups. In this stage, PSYOP personnel design PSYOP themes and messages and select the means to convey those messages.

Executing and Monitoring Approved PSYOP Plans

This planning stage requires follow-up to make sure PSYOP actions occur on time and PSYOP products are distributed on schedule. PSYOP personnel evaluate actions as they occur and assess overall results. The PSYOP cycle is shown at Figure 7-8.

Agents of Action

PSYOP planners consider using agents of action to enhance the supported unit's operational missions. Agents of action are persons

or organizations who carry out PSYOP action programs. Agents of action are non-PSYOP assets and units that conduct psychological operations action programs. Incidental agents are those whose activities have a psychological effect that is secondary to their operations. Discretionary agents, on the other hand, conduct activities that are primarily for psychological effect. The PSYOP staff officer must brief these agents about inadvertently releasing sensitive information. PSYOP planners must remember that PSYOP support maneuver operations, not vice versa. The commander and his operations officer must invest the time, manpower, and assets needed to conduct PSYOP programs. The PSYOP support plan must be reasonable, timely, and achievable. When planning PSYOP, commanders must rely on their own experiences and the experiences of other PSYOP planners of their commands. They can also study the after-action reports and lessons learned from other operations.

Impact Evaluation

Recent operations in Central America and the Middle East have again emphasized the criticality of the continuous study of the psychological effects of military operations. These operations have also emphasized the importance of maintaining continuous PSYOP-specific evaluation and input to military activities in all overseas areas. When evaluation, liaison, and image-projection programs are already in existence, it makes the deployment or augmentation of friendly forces easier.

PSYOP planners and liaison officers must pursue chances to make these assets available to commanders and their staffs.

OPSEC Considerations

OPSEC is a command responsibility. It is an integral part of every PSYOP mission, including planning, training, preparation, and support activities. It is a process of identifying critical information and analyzing friendly

actions attendant to military operations and other activities to—

- Identify those actions adversary intelligence systems can observe.
- Determine indicators hostile intelligence systems might obtain that they could interpret or piece together to derive critical information in time to be useful to them.
- Select and execute measures that eliminate or reduce to an acceptable level the vulnerabilities of friendly actions to adversary exploitation.

NBC Considerations

PSYOP units operate in an NBC environment under the same conditions as the units they support. PSYOP personnel use the standard NBC support measures to protect themselves and their equipment. PSYOP personnel must understand the initial and residual effects of NBC weapons and how to prevent NBC damage to their PSYOP-peculiar equipment. PSYOP units must be aware of their supported unit's SOPS for alarms, warnings, detection, and protection measures. Each PSYOP unit has its own

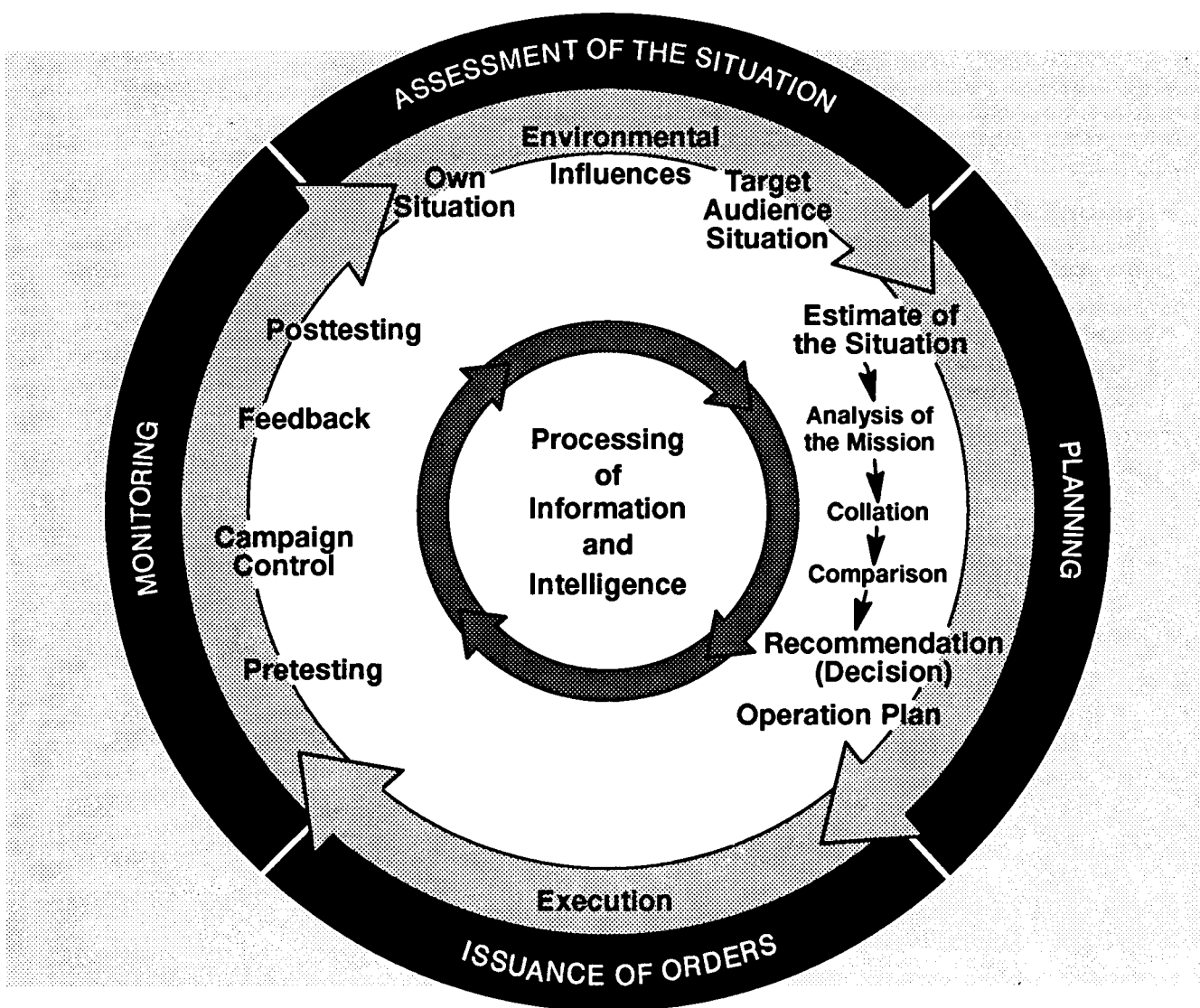

Figure 7-8. The PSYOP cycle.

NBC element that keeps the unit's NBC SOPS current. PSYOP units receive their NBC support on an area basis from the chemical unit supporting the TAACOM. NBC support requests go through the NBC center (NBCC) at their supporting area support group (ASG). Normally, however, these requests go to the NBCC at TAACOM headquarters or, if necessary, the TA headquarters. PSYOP units may also request support from NBC recon elements. These elements can conduct NBC recon anywhere in the

AO. The NBC warfare threat pervades all military operations across the operational continuum. The psychological impact of an NBC attack can be great. During Operation Desert Storm, for example, all coalition forces and neighboring countries were afraid Iraq would use chemical weapons. PSYOP personnel may develop programs to counter the effect of the opponent's use of NBC weapons. They may also develop PSYOP programs that exploit the friendly use of or the threat of use of these weapons.

POST-MISSION ACTIVITIES

During mission preparation, PSYOP commanders consider debriefing and other post-mission activities. These activities normally include—

- Collective debriefing of the operational element on all aspects of mission execution, including lessons learned.
- Collection of maps, notebooks, logbooks, loudspeaker employment reports, staff journals, and other documents pertinent to the mission after-action report.

- Maintenance of personal and unit equipment.
- Individual debriefing of key personnel.
- Rest and stand-down.
- Other reconstitution measures, as required.

Upon completion of these activities, the operational element begins pre-mission sustainment training or prepares for its next mission.

Chapter 8

Intelligence for PSYOP

PSYOP intelligence is information about a particular target audience. Commanders use this intelligence to plan for and conduct PSYOP. This intelligence includes the identity, location, conditions, vulnerabilities, susceptibilities, and effectiveness of a designated target audience. Since most intelligence is generated for general purpose forces, the analyst must glean PSYOP-related information from this intelligence. This chapter identifies intelligence systems and products that the PSYOP practitioner must tap and use to support the commander's PSYOP effort.

INTELLIGENCE AND ELECTRONIC WARFARE

The mission of Army intelligence and electronic warfare (IEW) units is to support the commander with indications and warning (I&W), situation development, target development, EW, and CI. All these missions are helpful to in-theater PSYOP units, if properly and selectively applied. PSYOP intelligence personnel must articulate their commander's needs to the IEW community.

I&W Information

I&W information is used to develop and refine a list of enemy threat indicators and possible intentions. Time-sensitive sources, often at the national level, collect this information. Over time, this information provides data of interest to PSYOP personnel.

Situation Development

Situation development is the basic process by which Intelligence is created. This process follows the intelligence preparation of the battlefield (IPB) procedures. The IPB procedures are further modified to assist the PSYOP commander and his SM in preparing contingency and campaign plans. For example, planners must know precisely the effects of weather and terrain in the area of operations (AO) because these factors will directly influence unit mission in every functional area.

Target Development

Target development must be integrated with situation development. It lets the

commander determine who the target audience is and what means he must use to influence it. Target data must be timely and accurate enough to allow for target neutralization early in a conflict, regardless of its size.

Electronic Warfare

EW units disrupt, exploit, and deceive military or civilian hostile force command and control systems. Close coordination with EW units is essential for the PSYOP commander's planning and operational mission. EW

units must be identified and included in PSYOP contingency plans.

Counterintelligence

CI units conduct operations to detect, evaluate, counteract, or prevent our adversaries from collecting information on U.S. forces. When tasked, CI units can provide invaluable information on most aspects of PSYOP target audience characteristics. PSYOP unit S2s maintain close and continuous liaison with adjacent and supporting CI organizations.

IEW SUPPORT ARCHITECTURE FOR PSYOP

In the intelligence "big picture," IEW consists of U.S. assets, non-DOD assets, and HN assets that collect intelligence.

U.S. Intelligence Assets

U.S. intelligence assets generate strategic, operational, and tactical intelligence.

Strategic Intelligence

The Defense Intelligence Agency (DIA), the Central Intelligence Agency (CIA), and the National Security Agency generate strategic intelligence at the national level. These agencies provide analytical services, finished intelligence products, extensive data bases, and other services of interest to PSYOP units. The unit collection manager must use the established DOD system to ensure the intelligence material produced by these agencies reaches the PSYOP planners.

Operational Intelligence

Army EAC military intelligence brigades generate operational intelligence at the theater level. These brigades are tailored to support the regions in which they operate and can provide vital intelligence to PSYOP

commanders. These brigades contain five intelligence discipline-specific organizations and a fusion center

- Human Intelligence (HUMINT).
- Signals Intelligence (SIGINT).
- Imagery Intelligence (IMINT).
- Technical Intelligence (TECHINT).
- Measurement and Signature Intelligence (MASINT).
- Fusion Center.

HUMINT units debrief prisoners of war, detainees, and other personnel. They exploit documents. These units conduct long-range surveillance. They also perform liaison with HN forces and conduct low-level and controlled collection activities.

SIGINT units collect, locate, evaluate, analyze, and fuse intercepted enemy emissions.

IMINT is collected by EAC units using optical and inbred sensors, imaging radars, electro-optical sensors, and multispectral sensors.

TECHINT is the product of captured, confiscated, or gratis enemy materiel evaluated for its potential use against friendly forces (including PSYOP-related equipment).

MASINT results from the analysis of technical and scientific data derived from special sensors. This information can be used to identify enemy and/or hostile electronic equipment.

Each theater fuses the collection of discipline-specific information in a joint intelligence center (JIC). It is the center for collection management, all-source intelligence production, and the coordination of all theater intelligence support. The JIC should be able to fill most PSYOP operational intelligence requirements.

Tactical Intelligence

Both conventional and SOF intelligence organizations at corps level and below generate tactical intelligence. At this level, HUMINT is intensive because it interfaces with the local population. Linguists and interrogators will therefore be in high demand. PSYOP intelligence personnel must plan carefully with supported commands for access to tactical HUMINT information. The key to tactical intelligence is the swift exploitation of collected information. Other disciplines used at the tactical level include CI and IMINT. CI aids in operational security, deception, and force protection. IMINT assists in mission planning for such occurrences as natural and artificial disasters.

Non-DOD Assets

Virtually all PSYOP missions will need intelligence assistance from non-DOD agencies. Unit S2s and collection managers must be aware of these agencies and their intelligence-related products. The information provided by these agencies may prove

invaluable to the success of PSYOP. Listed below are major agencies that produce PSYOP-related intelligence on a routine basis:

- Department of Justice and the Drug Enforcement Administration (found in most narcotics-producing nations),
- Federal Bureau of Investigation.
- Immigration and Naturalization Service.
- U.S. Marshals' Service.
- Department of Treasury, to include the U.S. Customs Service and the Bureau of Alcohol, Tobacco, and Firearms.

Other agencies that could provide PSYOP-related data include—

- DOS.
- DOT.
- U.S. Agency for International Development.
- USIA.
- Department of Commerce.
- Federal Aviation Administration.
- Foreign Broadcast Service.
- U.S. Border Patrol.

Host Nation Assets

The U.S. Embassy or Consulate—where a U.S. military group commander and a variety of DOD and non-DOD agencies are represented—is the center for HN intelligence support. These embassy-sponsored organizations possess a wealth of information of PSYOP interest. These organizations also provide an “in” to HN agencies available to support PSYOP planners.

IEW SUPPORT TO PSYOP

PSYOP programs need current, accurate information. PSYOP units must have an aggressive intelligence collection management process. PSYOP commanders must ensure

their intelligence collection managers formally request from Army production organizations (for example, the U.S. Army Intelligence and Threat Analysis Center)

PSYOP-related products to support contingency planning and current operations. Collection managers may also formally request support from non-DOD organizations. The best PSYOP-related intelligence collectors and producers include the CIA the DIA and the DOS. Trained collection managers request formal routine support from these sources of information. These organizations cover every country in the world for intelligence purposes.

Most analysts in intelligence organizations are aware of PSYOP and CA requirements. Although much intelligence at the national and theater level is for general purpose forces, most products address PSYOP-related matters.

PSYOP commanders must ensure their intelligence personnel are an integral part of the supported command's all-source intelligence center (ASIC), echelons above corps intelligence center (EACIC), or like element. As a minimum, PSYOP liaison personnel should work in or closely with the supported

unit's intelligence organization. PSYOP intelligence personnel extract PSYOP-related information from all incoming reports, paying attention to the target audience's cultural, social, economic, religious, and political environments.

PSYOP commanders usually request intelligence support from the—

- USACAPOC, G2.
- USASOC, G2.
- Theater Army special operations support command intelligence support element.
- U.S. Army Intelligence and Security Command's EAC brigades assigned to theaters.
- USSOCOM, J2.

Numerous other Service intelligence organizations are available for support, depending on task organization, including HN intelligence services. The PSYOP unit's S2 must ascertain the identity, location, and capabilities of these intelligence organizations.

PSYOP ANALYSIS PROCESS

The intelligence preparation of the operational area (IPOA) is accomplished through the PSYOP analysis process. The PSYOP analysis process is essential to successful PSYOP mission accomplishment. A PSYOP program prepared without this analysis process jeopardizes the PSYOP mission and the supported commander's mission.

The PSYOP analysis process is a cyclical process of intelligence analysis and evaluation. PSYOP personnel use this systematic and continuous process to analyze and integrate intelligence data on area characteristics. The process is a modification of the procedures for the IPB. (See Figure 8- 1.) The IPB focuses on threat evaluation, battlefield area evaluation, terrain analysis, and weather analysis, The PSYOP analysis process

builds on the IPB but is people oriented as opposed to terrain oriented. The process looks at target audiences within and outside the AO. The PSYOP analysis process correlates—

- Climate and weather analysis.
- Demographic evaluation and target audience analysis.
- Operational area evaluation.
- Geographic analysis.
- Data base integration.

The PSYOP analysis process uses these elements to analyze data about expected target audience behavior and to identify requirements for desired behavior changes. A list of considerations for the process follows.

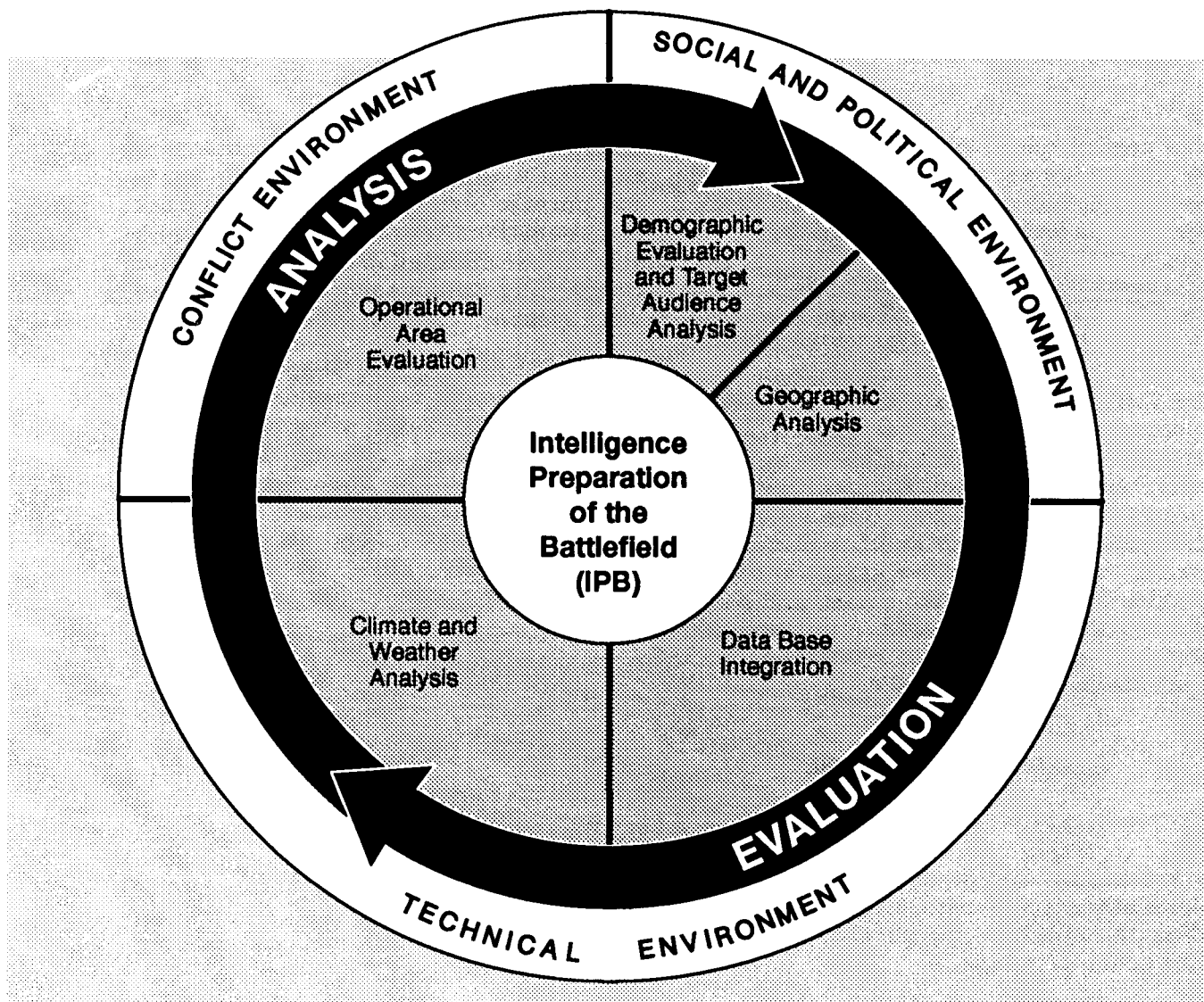

Figure 8-1. The PSYOP analysis process.

Climate and Weather Analysis

The analysis of the weather's effects on PSYOP media and dissemination requires special care. Wind direction, wind speed, and seasonal changes may affect PSYOP planning. Data from such an analysis influence timing, dissemination techniques, and media and program selection.

Demographic Evaluation and Target Audience Analysis

PSYOP population studies analyze demographic, social, cultural, economic, political, religious, and historical factors within the

area. All SOF units conduct similar studies while preparing for operations. These units should coordinate their population evaluations. Such coordination promotes credible results and increases the chances for successful military operations.

Target audience analysis is a key part of the PSYOP analysis process. PSYOP personnel study potential target audiences within the area. They also study the PSYOP program's effects on audiences not in the immediate operational area. The PDC examines target audiences for vulnerabilities and credible communicators, keeping in mind the available PSYOP assets. The PSYOP commander then balances available resources against expected results for each target audience. In

this part of the PSYOP analysis process, PSYOP personnel also analyze the opponent's propaganda and consider counter-propaganda techniques.

Operational Area Evaluation (OAE)

The OAE begins with a BPS or SPS of the operational area. PSYOP personnel add intelligence data to these studies for specific PSYOP support missions. The product development center (PDC) prepares a matrix of the operational area during the OAE. The matrix identifies possible target groups, credible leaders, preferred media, and possible PSYOP issues. The PDC analyzes data about accessible and effective targets within and outside the operational area.

Geographic Analysis

PSYOP terrain studies consider how the area's geography affects the culture, population density, and product dissemination. Mountain ranges, valleys, and river systems affect the PSYOP element's ability to conduct action programs.

Data Base Integration

The final step in the PSYOP analysis process is the integration of all studies and analyzed data into a data base for PSYOP planners. This step relies heavily on event templating and matrix development. The PSYOP analysis process is people oriented, as opposed to terrain oriented. The event template and matrix focus on the expected results of friendly, opposing, and nonbelligerent third-party actions. After examining the effect of a specific theme or action, the PDC recommends target audiences. The PDC classifies them as high-value targets (HVTs) or high-payoff targets (HFTs). Including HVTs in the program boosts the credibility of PSYOP messages. Including HFTs advances national goals within the AO. HVTs normally are not the program's end product, but they may help influence HFTs. The PSYOP

analysis process lets PSYOP personnel provide timely, expert advice to SOF and general purpose unit commanders throughout the operational continuum. Numerous automated information systems exist for integrating data bases. The newest of these systems is SOCRATES.

SOCRATES is a USSOCOM-sponsored program. Its purpose is to provide automated intelligence data, voice, secondary imagery dissemination, and FAX worldwide to the SOF community. The SOF community includes USSOCOM components, major subordinate units, and RC and National Guard units in CONUS and OCONUS. The three SOCRATES components are:

- SOCRATES local area network (LAN).
- SOCRATES stand-alone capability (SAC).
- SOCRATES extension (EXT).

SOCRATES LAN

SOCRATES LAN consists of on-line computers, workstations, printers, and phones. Fiber optic cable is the communications carrier for information transfer on the LAN. Computer workstations operating in the SOCRATES LAN serve USASOC, USACAPOC, USAJFKSWCS, the 3d and 7th Special Forces Groups, and the 4th Psychological Operations Group.

SOCRATES SAC

SOCRATES SAC is an application using stand-alone computers with SOCRATES software uploaded on a periodic basis with hard disk intelligence data bases. SOCRATES SAC is fielded to Army National Guard and RC SOF units.

SOCRATES EXT

SOCRATES EXT extends the SOCRATES on-line capability to other SO locations—for example, Fort Campbell, Kentucky. SOCRATES can access national intelligence data bases, office automation functions, and PSYOP- and other SOF-peculiar data bases. The PSYOP Automated Data System (POADS) and SOCRATES may be interconnected on a future date.

Chapter 9

Combat Service Support

The PSYOP group or battalion is part of the TA and depends on it for CSS. In some theaters, however, a PSYOP group or battalion may depend on another Service's CSS system. This chapter describes how the internal PSYOP CSS system interacts with the TA CSS system to meet PSYOP requirements. When sustained by another Service, the PSYOP commander and his logisticians must adapt Army doctrine to the theater's CSS procedures. PSYOP commanders make sure the planners include logistics in OPLANS and work out support relationships before unit deployment.

THEATER ARMY

The TA supports assigned U.S. Army forces and, if directed, other U.S. Services and allies in a theater. A theater has a combat zone and a COMMZ. The combat zone begins at the rear boundary of the theater's senior combat echelon, normally a corps. It extends to the forward limit of the theater commander's AO. The COMMZ is behind the combat zone's rear boundary and includes the area needed to support combat zone forces.

The TA has two types of support organizations in the COMMZ: TAACOMS and TA functional commands. TAACOMS provide CSS and CS on an area basis to forces passing through or located in their area of responsibility. They have area responsibility for rear operations in the COMMZ. TA functional commands provide specialized

support (finance, personnel, engineer, transportation, and medical) to forces throughout the TA's AOR.

Two agencies fill key roles in the command and control of TAACOMS and TA functional commands. They are the TAMMC and the TAMCA. The TAMMC centrally manages most supply and maintenance operations. It serves as the primary TA link with the CONUS sustaining base. The TAMCA manages theaterwide movement and controls transportation assets.

The TASOSC is one of the TA functional commands. It plans and coordinates CSS to theater ARSOF (Figures 9-1 and 9-2). The TASOSC and PSYOP group or battalion staffs help identify and rank PSYOP CSS requirements. The TASOSC staff then works

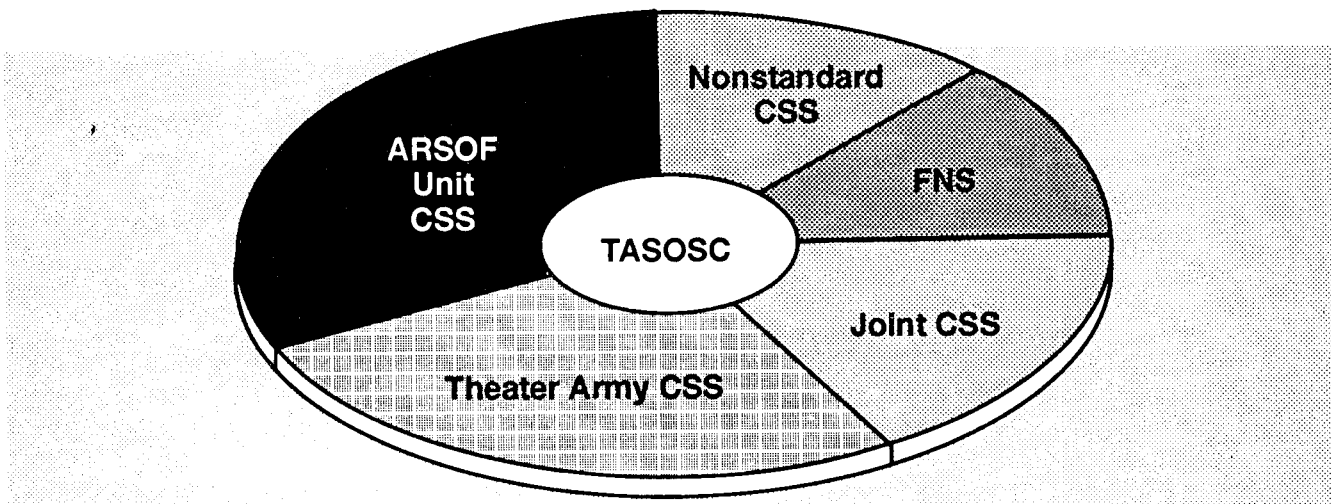

Figure 9-1 ARSOF CSS options.

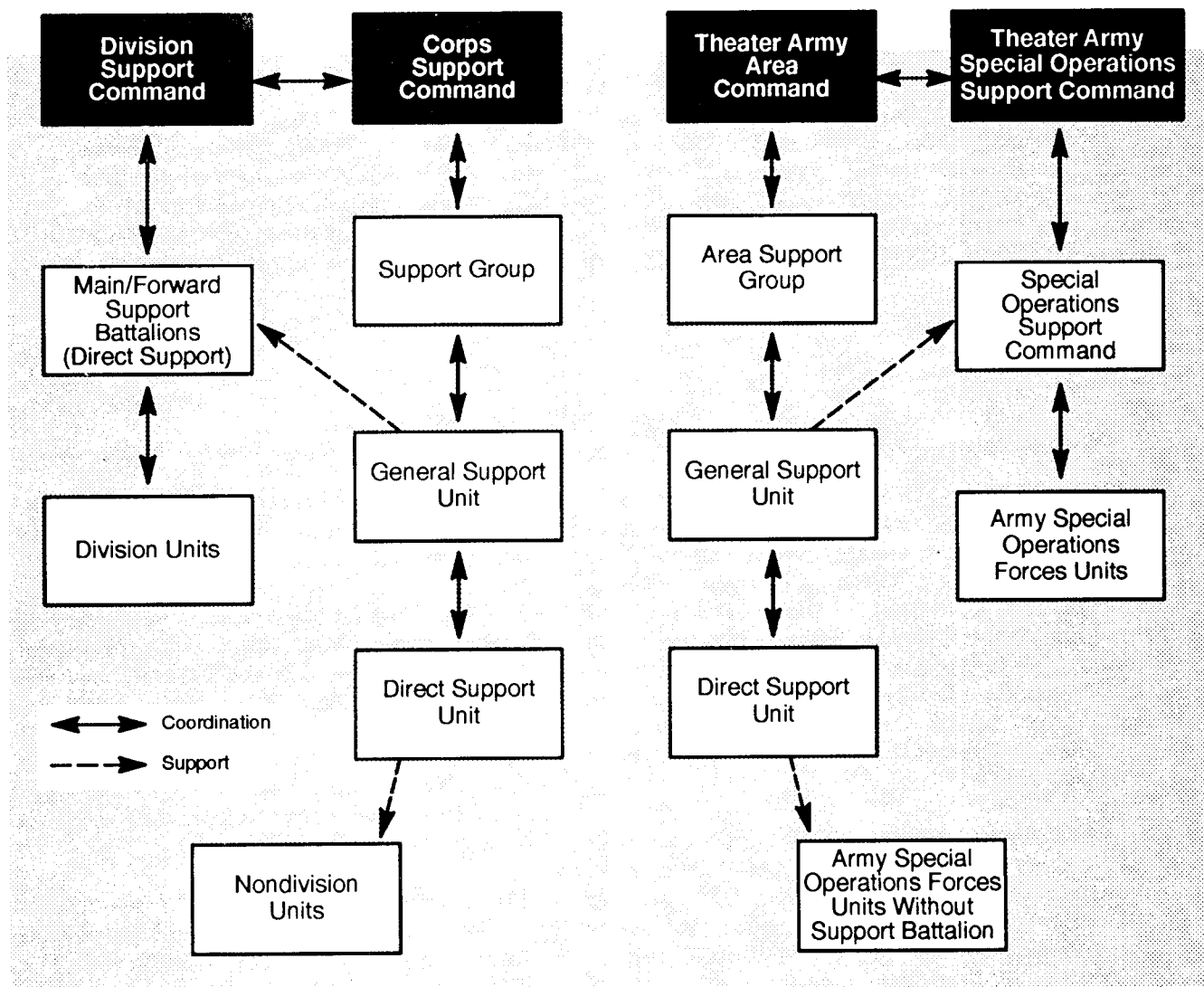

Figure 9-2. Comparison of support relationships.

with the other TA subordinate commands to meet those requirements by—

- Earmarking TA (or other Service) resources for support of or attachment to PSYOP groups or battalions.
- Arranging for FNS. An effective PSYOP program is virtually impossible without

native linguists. Speakers with unique skills, such as broadcasting and typing, best augment PSYOP units. The unified CINC places high priority on getting linguist support for PSYOP. Also, a standard mechanism must be in place to get needed CTA-50-900 items for NBC protection of HN linguists.

CSS AND PSYOP

PSYOP CSS personnel use their knowledge of conventional CSS operations to meet the specific CSS requirements of PSYOP units. (For a more thorough discussion of CSS, see FM 100-10, the Army's manual for CSS operations.) The PSYOP sustainment imperatives in Figure 9-3 apply to most PSYOP. (See page 9-4.)

PSYOP S4s provide or coordinate CSS for elements assigned or attached to their units. This CSS normally includes—

- Requisition, receipt, storage, and distribution of all classes of supplies.
- Procurement of nonstandard supplies and materiel.
- Bath facilities, laundry, and clothing exchange.
- Graves registration (GRREG) service.
- Potable water production, storage, and distribution.
- Unit and DS maintenance for all wheeled vehicles, power-generating equipment, signal equipment, and small arms.

- Limited general support (GS) maintenance for PSYOP-specific materiel.
- Salvage collection.
- Transportation service.
- Health service support.
- Personnel service support.

The PSYOP group, battalions, and subordinate companies will require augmentation to provide CSS support during sustained operations. When PSYOP support SO, the PSYOP group or battalion SM receiving the SOC mission letter prepares an SOR. The SOR consolidates and prioritizes all group or battalion requirements exceeding its organic capabilities. A complete SOR addresses in detail all aspects of CS and CSS. The S3 forwards the SOR to the TASOSC DPO for action. (See Figure 7-7.) Based on guidance from the SOC, the TASOSC DPO validates, consolidates, and prioritizes all theater ARSOF SORs. Such augmentation is often necessary when—

- The PSYOP units are in immature theaters to support contingency operations.
- The PSYOP units are not in fixed bases.

SOURCES OF SUPPLY

PSYOP units draw their supplies from a variety of sources. The importance of each source relates to its theater. PSYOP commanders forecast their logistical needs and then coordinate with their supporting TASOSC, if it is supporting PSYOP units in

theater, to determine the best source of supply. In the absence of TASOSC support, PSYOP units will go directly to the TMCOM to determine the best source of supply. Among these sources of supply are war reserve materiel stocks (WRMS) and FNS.

- Maximize use of FNS to include local and third country supplies, services, and other resources.
- Maximize use of existing fixed facilities.
- Limit CSS requirements to mission essentials.
- Concentrate maintenance efforts on returning major end items to service.
- Rely on ALOC for rapid resupply.
- Maximize use of accompanying supplies, pre-positioned stocks, and preplanned resupply packages.
- Anticipate high attrition during resupply missions into denied territory.
- Identify to the TA as early as possible low-density items requiring operational readiness floats or other special logistical arrangements.

Figure 9-3. PSYOP sustainment imperatives.

War Reserve Materiel Stocks

- WRMS in tailored packages for deployment with the PSYOP group or battalion.

The TASOSC commander, with the PSYOP group or battalion commander, should get enough pre-positioned war reserve materiel stocks (PWRMS) in the theater to fill unit requirements. He also fills shortages in existing WRMS, such as leaflet bombs. Alternative include—

- PWRMS afloat near the theater of operations.
- PWRMS in a third country support base (TCSB).

Foreign Nation Support

FNS is the preferred means to meet unresourced CSS requirements, within acceptable risk limits. FNS can include almost every aspect of CSS. Foreign personnel and organizations can perform many CSS functions as well as or better than their U.S. counterparts. The group or battalion commander, with the CA commander, decides what FNS will not be risky to operational security and mission accomplishment.

CSS IN A MATURE THEATER

CSS in a mature theater has an established theater sustainment base providing logistics and personnel service support.

Logistics

The mature theater has an established theater sustainment base. PWRMS are in place. FNS agreements exist. In a mature theater, the PSYOP battalion or group supply officer (S4) performs four logistics

functions: supply, field services, maintenance, and transportation. The following paragraphs show how the S4, working with the S1 and S3, performs those functions.

Supply

The S4 section provides needed Class I through IV, VI, and VII supplies (Figure 9-4). These supplies come from the DS supply and service (S&S) company in the TAACOM ASG. All these classes of supplies, except











		SUBCLASSES
CLASS I		Subsistence items and gratuitous-issue health and welfare items.
		A - Nonperishable C - Combat Rations R - Refrigerated S - Other Nonrefrigerated W - Water
CLASS II		Individual equipment, military clothing, tools, tentage, and housekeeping supplies.
		A - Air B - Ground Support Material E - General Supplies F - Clothing G - Electronics M - Weapons T - Industrial Supplies
CLASS III		Petroleum, oils, and lubricants.
		A - POL for Aircraft W - POL for Surface Vehicles P - Packaged POL
CLASS IV		Construction and barrier materials.
		A - Construction B - Barrier
CLASS V		Ammunition, including chemical and nuclear ammunition.
		A - Air Delivery W - Ground Delivery
CLASS VI		Personal demand items that are normally sold through the exchange system.
CLASS VII		Vehicles and weapon systems.
		A - Air B - Ground Support Material D - Administration Vehicles G - Electronics J - Racks, Adapters, Pylons K - Tactical Vehicles L - Missiles M - Weapons N - Special Weapons X - Aircraft Engines
CLASS VIII		Medical supplies and equipment.
		A - Medical Materiel B - Blood/Fluids
CLASS IX		Repair parts and components, including kits and assemblies.
		A - Construction B - Barrier A - Air B - Ground Support Material D - Administration Vehicles G - Electronics K - Tactical Vehicles L - Missiles M - Weapons N - Special Weapons T - Industrial Materials X - Aircraft Engines
CLASS X		Material required to support nonmilitary programs.
MISC	Items that do not fit into one of the ten classes above, such as maps, captured enemy materiel, and salvage material.	

Figure 9-4. Classes of supplies.

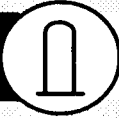
bulk Class III, are demand items. The using unit submits a request through the service detachment of the DS S&S company to the direct support unit (DSU). The DSU either fills the request from its existing stocks or forwards the request to its GSU. The DSU uses a combination of supply point, unit, and throughput distribution. With no Army exchanges (PXS), the S4 requests and receives Class VI sundry packages as it does Class I supplies. (See Figure 7-7.)

Bulk Class III supplies are scheduled items. Based on input from the battalions, the PSYOP group S4 forecasts unit needs through logistics channels to the TAMMC. The TA Deputy Chief of Staff for Logistics (DCSLOG) and TAMMC review field availability information and unit priorities. They then develop fuel distribution plans for subordinate units.

The S4 requests and receives nonstandard PSYOP-specific items through the TAMMC. The TAMMC fills the request from theater or TA operational project stocks.

The S4 requests, draws, and stores Class V supplies from the supporting ammunition supply point (ASP). An ordnance company of the TA ammunition group operates the ASP using supply point distribution. Class V supplies are scheduled items, not demand items. Based on input from the battalions, the PSYOP group S3 determines the group's operational needs. These needs are primarily the unit basic load (UBL) and required supply rate (RSR). He then submits them for approval and distribution by the TA Deputy Chief of Staff for Operations and Plans (DCSOPS). Based on his guidance, the TA DCSLOG and TAMMC distribute scarce Class V items using a controlled supply rate (CSR). Once the PSYOP group commander receives his Class V allocation, he distributes it among his subordinate elements. Based on this distribution, the PSYOP group and battalion S3s approve unit Class V requests before the S4s fill them.

The PSYOP unit's maintenance section requests, receives, and stores Class IX supplies from its DS maintenance company in

the ASG. The DSU uses supply point distribution. Class IX resupply items are demand items. The using unit submits its request to the mechanical maintenance section. It forwards the request to the DSU. The DSU either fills the request from its existing stocks or forwards the request to the TAMMC.

The S4 receives and stores Class X supplies from the CA brigade supporting the TAACOM. The CA brigade uses a combination of unit, supply point, and throughput distribution. The using unit submits its request through the base S5. He forwards the request through CA channels.

The S4 gets water from local sources. When water needs exceed the local supply, the section gets water from its DS supply and service company supply point. The DSU uses supply point distribution.

The S4 requests and receives unclassified maps from its DS S&S company. The DSU gets its unclassified maps from the proper TA map depot. Using units submit their requests to the S2, who combines them and forwards the request through supply channels. The S2 requests and receives classified maps and other classified intelligence products through intelligence channels.

During transitions and breaks in normal resupply, PSYOP units maintain UBLs of Class I through V, VIII, and IX supplies. Commanders review their UBLs at least yearly to be sure they meet current operational needs. A periodic check of UBLs ensures their proper maintenance, rotation, security, and requests for replacements.

Field Services

Field services include GRREG, clothing exchange, bath, laundry, bread baking, textile and clothing renovation, and salvage. GRREG is a primary field service because it is essential to the sustainment of combat operations. AU others are secondary field services.

PSYOP teams that sustain fatalities identify the human remains, place them in human remains pouches, and mark any that are

contaminated. They then take the remains to the service detachment of the DSU for evacuation to the supporting GRREG collection point. When PSYOP teams cannot evacuate their dead, they conduct emergency burials and report the burials to the group or battalion. The group or battalion S4 submits a record of interment through GRREG channels. Whenever possible, the PSYOP group chaplain or the PSYOP team leader conducts a proper service to honor the dead.

The PSYOP unit may not have fixed facilities or civilian contractors to provide secondary field services. In this situation, its DS S&S company provides these services as soon as the situation permits.

Maintenance

The PSYOP unit's own maintenance section performs unit-level wheeled-vehicle and power-generating equipment maintenance. Unit armorers perform decentralized or combined unit-level small-arms maintenance. There is a constant need for good relationships with SOF support units, EAC maintenance units, and corps maintenance units for communications maintenance support. Coordination for this support takes place well in advance of deployments.

A unit may not be able to repair an item of equipment. The DS maintenance company would then take the item or provide on-site repair with its mobile maintenance support team. The DS maintenance company sends items it cannot repair to GS maintenance units. It also provides a direct exchange service and maintains a limited operational readiness float (ORF).

The group relies on civilian technicians and personnel with civilian training to repair PSYOP-specific equipment the Army cannot repair. The Army may also send such equipment to CONUS for repair by the manufacturer or another selected facility.

Transportation

Transportation services in the theater include motor, rail, air, and inland waterway.

The Theater Army transportation command (TRANSCOM) exercises command and control of transportation node operating units in the COMMZ. The Corps Support Command (COSCOM) exercises command and control of transportation node operating units in the Corps. The Division Support Command exercises command and control of transportation node operating units in the Division.

Transportation units receive commitments to provide transportation services from the movement control organization in their command. These movement control organizations are the single point of contact for PSYOP units to coordinate for transportation requirements beyond their organic capability. The movement control organization in the COMMZ is the TAMCA or transportation battalion. The movement control organization in the Corps is the movement control team assigned to the Corps movement control center. PSYOP units operating in the division area will coordinate with the division transportation officer.

Personnel Service Support

PSS covers personnel services, public affairs, legal services, finance services, and religious support. PSYOP units plan and conduct most PSS using standard Army systems and procedures.

Personnel Services

PSYOP group and battalion S1s deal directly with their supporting personnel services company (PSC). When different PSYOP units use the same PSC, the group S 1 may be required to consolidate subordinate unit reports.

The S1's responsibilities include—

- Strength management.
- Casualty reporting
- Replacement operations.
- Postal operations.

Strength Management. Strength management determines personnel replacement needs and influences personnel transfer and

replacement distribution decisions. The group and battalion S1s maintain personnel data bases using the Army personnel accounting and strength reporting system. They forward their daily personnel summaries and personnel needs reports to the supporting PSC. The battalion S1s provide copies of their reports to the group S1 who then prepares a combined report for the group commander. Information copies of the report go to the TASOSC Director of Personnel and Administration (DPA). The supporting PSCs use these reports to submit requests for individual replacements to the TA personnel command (PERSCOM).

Casualty Reporting. The Army's casualty management system gives Army headquarters information for next of kin and casualty and survivor aid programs. By-name casualty accounting and reporting has far-reaching effects on military and civilian morale and the Army's image. Casualty reporting must be 100 percent accurate and as rapid as the situation permits. The PSYOP unit submits its casualty feeder reports and, if required, witness statements to the battalion or group S1. The S1s combine casualty reports and forward them to the supporting PSC. They manage open cases (for example, soldiers missing in action) until closed and prepare commanders' letters of sympathy. The PSC checks and rechecks the information before starting a formal individual casualty report. The battalion S1s provide information copies of all by-name casualty reports to the group S1.

Replacement Operations. PSYOP replacement operations involve the receipt, processing, and distribution of individual and small unit replacements. The PSYOP group gets its

individual replacements from the supporting PERSCOM through normal replacement procedures. The S1 and Command Sergeant Major distribute replacements based on the commanders priorities.

Postal operations. Postal operations move, deliver, and collect personal and official mail. A DS postal platoon normally collocates with the supporting PSC. The group and battalion S1s set up internal procedures to collect and deliver mail. These procedures must include provisions for redirecting the mail of deceased, missing, and evacuated personnel. The S1s must also provide for deployed PSYOP personnel who cannot receive or send mail for operational reasons.

Finance Operations

Finance operations provide normal finance support to PSYOP personnel as well as operational funds PSYOP teams need for their missions. A finance support command (FSC) normally collocates with the supporting PSC to provide the full range of finance services. These services include special-mission fund accounts, intelligence contingency fund accounts, foreign currency operations, and commercial accounts. Group budget personnel and the supporting FSC commander set up procedures for PSYOP teams to get operational funds. Each PSYOP officer who receives these funds must ensure payments are valid and accounting procedures are proper. Funding should be provided for or established no later than upon arrival in the theater. The optimal solution is to establish budgetary relationships or agreements during peacetime for contingency needs.

CSS IN AN IMMATURE THEATER

An immature theater does not have a significant U.S. theater sustainment base. PWRMS, in-theater operational project stocks, and FNS agreements are minimal or

nonexistent. A PSYOP unit deployed into an immature theater must bring enough resources to operate until it gets help. The TA will either set up a bare base support system

or arrange for HN and third country support. The bare base support system may function from CONUS or at a TCSB. The system may also operate afloat, through amphibious shipping or mobile sea bases. It will probably rely heavily on strategic airlift or sealift or both for resupply.

CSS Options

Deployed PSYOP units in an immature theater may have to bypass normal CSS levels. They may maintain direct contact with their parent units in CONUS or requisition directly from the CONUS wholesale logistics system. They may coordinate directly with an ASG or directly with the TAACOM as an EAC unit if the TASOSC is not in place and operating. They may rely on TASOSC contracting and CA expertise to get FNS. In practice, the solution may be some combination of all these options.

Support Relationships

The TASOSC commander arranges regular support relationships between the PSYOP group and the TA elements providing its support package. The support package should be a composite support battalion or company. That way, the group commander avoids dealing with teams, detachments, and companies that have no parent control headquarters.

Supply

Normal basic loads are inadequate for PSYOP in an immature theater. For example, a PSYOP unit may have to deploy with 30 days of supplies. This requirement amounts to 15-day order-ship time, 10-day operating level, and 5-day safety level. Accompanying supplies normally include only the unit's basic and prescribed loads, plus operation-critical Class I, III, and V supplies. The group and battalion S3s and S4s must include accompanying supplies in all their predeployment load planning.

Supply procedures for most classes of supplies vary in an immature theater. The group

or battalion may rely upon local contract support for fresh Class I supplies and mess hall operation. To reduce demand on the CSS system, the PSYOP unit may purchase certain supplies locally or from third party contractors. Items approved for such purchase are Class II, III, IV, and VI supplies. It receives Class V and IX supplies through the standard U.S. system, relying mainly on air lines of communication. The PSYOP unit may stock low-density, high-cost repair parts not normally authorized at unit maintenance level. Class VII supplies may include a combination of military and commercial equipment from U.S. and foreign sources. Replacement unserviceable equipment depends upon the operation's length, theater GS repair capability, loss rates, and ORF or PWRMS availability. The PSYOP unit gets water from its custodial support contractors, local sources, or U.S. water supply points.

Field Services

The PSYOP group or battalion normally receives TA support to perform GRREG when such service is unavailable in the COMMZ. The group or battalion may contract for general custodial services, such as laundry, barber, and PX services. If laundry services are unavailable, the group or battalion S4 must arrange for clothing exchange through the standard U.S. system.

Maintenance

The PSYOP group commander emphasizes preventive maintenance in the extreme (tropical, arid, or arctic) environments typical of immature theaters. He may adjust the frequency of periodic services to aid in equipment readiness. He may also contract for supplemental maintenance support of the group's Army and commercial equipment.

When fixed repair facilities are unavailable, the PSYOP group may make repairs not normally performed at unit level. The commander reviews the modification table of organization and equipment to determine the additional test, measurement, and

diagnostic equipment needed to meet increased maintenance demands.

Transportation

Because immature theaters typically have poor ground lines of communications, Army aviation units deploy early to support CSS operations. The PSYOP group or battalion commander may contract for foreign transportation assets to meet his unresourced transportation requirements.

Personnel Service Support

PSS remains essentially unchanged in an immature theater. The role of finance units in supporting local procurement and commercial vendor service activities increases dramatically. TA contracting and CA experts working with the finance units can reduce the strain on the logistics system and aid in obtaining FNS and local hire, thereby multiplying PSYOP unit capabilities in undeveloped theaters.

RECONSTITUTION

Reconstitution Options

Reconstitution operations are specific actions taken to restore units that are not combat effective. Reconstitution involves more than a surge in normal sustainment operations. Training, unit organization, and human factors that build cohesion and esprit de corps heavily influence the reconstitution decision. The commander two levels above the attrited unit decides how to reconstitute it.

Commanders have two reconstituting options: reorganization and regeneration. A commander may execute these options separately, but most often he executes them in combination.

Reorganization

Reorganization restores combat effectiveness within an attrited unit. Some reorganization measures include reestablishing command and control, evening resources between subunits, and matching surviving weapons with surviving crews. Commanders may also combine attrited subunits to form one combat-effective subunit. The senior survivor of an attrited unit assumes com-

mand and immediately begins reorganization pending the reconstitution decision of higher headquarters.

Regeneration

Regeneration rebuilds an attrited unit through mission-essential training and large-scale replacement of personnel and materiel. Replacement personnel and materiel may come from redistributed resource reserves or the resources of higher or supporting levels.

Redistribution

Commanders who see they cannot restore an attrited unit to combat effectiveness may use redistribution instead of reconstitution. Redistribution reduces an attrited unit to zero strength and transfers its remaining resources to other units. Redistribution is the least desirable option.

The PSYOP group commander may decide he cannot restore the combat effectiveness of an attrited PSYOP unit. He would then give another PSYOP unit its mission. He may attach survivors of the attrited PSYOP unit to the new PSYOP unit, particularly if it was operating in denied territory.

RESUPPLY OF PSYOP UNITS

A PSYOP unit determines the quantity and types of equipment and supplies it needs. The following factors influence the decision on accompanying supplies:

- Assigned mission and scope and duration of operations.
- Resistance force size, capabilities, logistical needs, and responsiveness to U.S. control.
- Hostile capabilities.
- Availability of resources in the AO.
- Method of operation.
- Difficulty of repairing or replacing critical items in the AO.

Based on the same considerations, the PSYOP staff sets levels for each class of supply in the AO. The staff also determines the sequence, method, and timing of delivery. The PSYOP commander may recommend changes to the resupply schedule.

The PSYOP battalion or group S4 schedules three types of resupply missions: automatic, emergency, and on-call. The supplies and equipment for these missions come from theater or TA war reserve stocks.

Automatic Resupply

An automatic resupply replaces lost or damaged equipment and provides items that could not accompany the PSYOP unit. Automatic resupply provides essential subsistence, training, and operational supplies to PSYOP teams and their indigenous forces on pre-arranged schedules. It has a set delivery time, location, content, identification marking system, and authentication. The S4 automatically delivers the items

unless the deployed PSYOP unit cancels, changes, or reschedules the delivery.

Emergency Resupply

An emergency resupply contains equipment and supplies to restore operational capability and survivability to the unit. The S4 plans emergency resupplies as it does automatic resupplies, delivering them under either of the following conditions:

- The deployed PSYOP unit does not have radio contact with the PSYOP headquarters within a set time after leaving.
- The deployed PSYOP unit fails to make a set number of consecutive scheduled radio contacts.

On-Call Resupply

An on-call resupply provides equipment and supplies to the deployed PSYOP unit to meet unforeseen operational needs. TAACOM depots hold on-call supplies in readiness for immediate delivery when the PSYOP unit requests them.

PSYOP units use the catalog supply system (a brevity code system) to rush on-call resupply requests. This system also ensures accurate identification of supply items and reduces message length. The system's catalog lists equipment and supplies by class, grouping associated items into convenient unit sets with assigned code words. The TASOSC DOL prepares the theater supply catalog and places operational project stocks into unit sets. The TASOSC signal officer reproduces the catalog as a signal operation instructions item.

Appendix A

PSYOP Capabilities, Assets, and Target Audiences in Military Operations

PSYOP support a wide variety of military operations across the operational spectrum. This appendix provides samples of PSYOP support and the lead time required for different military operations.

MISSION	PSYOP CAPABILITY														ASSET										TARGET											
	Intelligence	Language	Face-to-Face Comm	Leaflet: Contingency	Leaflet: Prepack	Handout, Poster	Audio: Live	Audio: Pre-recorded	Audiovisual: Live	Audiovisual: Pre-recorded	Command and Information	Awareness Programs	Counterpropaganda	Training	Mill Ops Effects Analysis	Liaison	Research and Analysis	Interpreters, Region, Exp.	Print: Mobile	Print: Fixed	Radio: Mobile	Radio: Fixed	Loudspeaker	Television/Movie	Mobile Training Team	Oposing Combatant	Opponent Rear Echelon	Opponent's Ally	Other Belligerents	Nonbelligerents	Friendly Civilian	Hostile Civilian	Key Communicators	Special Interest Groups		
Offense																																				
Close	x	x		p*	p*		x	p	p	p	p	p	d		x	x	x	x	p*	p*	p	p	x	p		p	p	p	p	p	p	p	p	p		
Deep	x	x		p*	p*		p	p	p*	p*		p			x	x	x	x	p*	p*	p	p		p*		p	p	p	p	p	p	p	p	p		
Rear	x	x	x	p	p	p	x	p	p	p	x	p	p		x	x	x	x	p	p	p	p	x	p		p	p	p	p	p	p	p	p	p		
Defense																																				
Close	x	x		p*	p*		x	p	p	p	p	p	d		x	x	x	x	p*	p*	p	p	x	p		p	p	p	p	p	p	p	p	p		
Deep	x	x		p*	p*		p	p	p*	p*		p			x	x	x	x	p*	p*	p	p		p*		p	p	p	p	p	p	p	p	p	p	
Rear	x	x	x	p	p	p	x	p	p	p	x	p	p		x	x	x	x	p	p	p	p	x	p		p	p	p	p	p	p	p	p	p	p	
Retrograde*																																				
Close	x	x		p*	p*		x	p	p	p	p	p	p		x	x	x	x	p*	p*	p	p	x	p		p	p	p	p	p	p	p	p	p	p	
Deep	x	x		p*	p*		p	p	p*	p*		p			x	x	x	x	p*	p*	p	p		p*		p	p	p	p	p	p	p	p	p	p	
Rear	x	x	x	p	p	p	x	p	p	p	x	p	p		x	x	x	x	p*	p*	p	p	x	p*		p	p	p	p	p	p	p	p	p	p	p
Strike	x	x		p*	p*		p	p	p*	p*		p			x	x	x	x	p*	p*	p	p	x	p*		p	p	p	p	p	p	p	p	p	p	
Rescue	x	x		p*	p*		p	p	p	p		p			x	x	x	x	p*	p*	p	p	x	p*		p	p	p	p	p	p	p	p	p	p	
NEO	x	x		p*	p*		p	p	p	p		p			x	x	x	x	p*	p*	p	p	x	p*		p	p	p	p	p	p	p	p	p	p	
Shows of Force	x	x		p*	p*		p	p	p*	p*		p			x	x	x	x	p*	p*	p	p	x	p*		p	p	p	p	p	p	p	p	p	p	
FID/IDAD	x	x	x	p	p	p	p	p	p	p	p	p	p		x	x	x	x	p*	p*	p	p	x	p*		p	p	p	p	p	p	p	p	p	p	
Insurgency	x	x	x	p	p	p	x	p	p	p	p	p	p		x	x	x	x	p*	p*	p	p	x	p*		p	p	p	p	p	p	p	p	p	p	
Counterinsurgency	x	x	x	p	p	p	x	p	p	p	p	p	p		x	x	x	x	p*	p*	p	p	x	p*		p	p	p	p	p	p	p	p	p	p	
Counterterrorism	x	x	x	p*	p*		x	p	p	p	p	p	d		x	x	x	x	p*	p*	p	p	x	p*		p	p	p	p	p	p	p	p	p	p	
Counterdrug	x	x	x	p*	p*		x	p	p	p	x	p	p		x	x	x	x	p*	p*	p	p	x	p*		p	p	p	p	p	p	p	p	p	p	
Peacemaking	x	x	x	p*	p*		x	p	p	p	p	p	p		x	x	x	x	p*	p*	p	p	x	p*		p	p	p	p	p	p	p	p	p	p	
Peacekeeping	x	x	x	p*	p*		x	p	p	p	p	p	p		x	x	x	x	p*	p*	p	p	x	p*		p	p	p	p	p	p	p	p	p	p	
Disaster Relief	x	x	x	p*	p*		x	p	p	p	p	p	p		x	x	x	x	p*	p*	p	p	x	p*		p	p	p	p	p	p	p	p	p	p	
Refugee	x	x	x	p*	p*		x	p	p	p	p	p	p		x	x	x	x	p*	p*	p	p	x	p*		p	p	p	p	p	p	p	p	p	p	
EPW/GI	x	x	x	p	p	p	x	p	p	p	p	p	p		x	x	x	x	p*	p*	p	p	x	p*		p	p	p	p	p	p	p	p	p	p	
Demonstrations	x	x	x	p	p	p	x	p	p	p	p	p	p		x	x	x	x	p*	p*	p	p	x	p*		p	p	p	p	p	p	p	p	p	p	
Occupation	x	x	x	p	p	p	x	p	p	p	p	p	p		x	x	x	x	p*	p*	p	p	x	p*		p	p	p	p	p	p	p	p	p	p	
Deception	x	x	x	p	p	p	x	p	p	p	p	p	p		x	x	x	x	p*	p*	p	p	x	p*		p	p	p	p	p	p	p	p	p	p	
Covert**																																				

* PSYOP in the retrograde will not be as effective. ** Classified mission tailoring required.

Figure A-1. PSYOP capabilities, assets, and target audiences in military operations.

Appendix B

P S Y O P i n t h e O p e r a t i o n a l C o n t i n u u m

Psychological operations support military operations across the operational continuum. This appendix cites examples of PSYOP support in the tactical, operational, and strategic levels during war. Examples are also provided for PSYOP support of peacekeeping, FID, contingency operations, and combatting terrorism operations. See Figures B-1 and B-2.

Peacekeeping Operations	Foreign Internal Defense Operations	Contingency Operations	Combatting Terrorism Operations
<ul style="list-style-type: none"> • Develop PSYOP products designed to maintain the consent of the local populace and belligerents concerning the presence of a peacekeeping force. • Project neutral image of the force as an uncommitted, nonaligned third party between hostile parties. • Develop, coordinate, and conduct— <ul style="list-style-type: none"> - Information and education programs. - Peacekeeping operations training for the forces of other nations involved in the mission. - Allied points of contact between all parties involved. - Area assessments to identify key leaders, key groups, and local sensitivities and susceptibilities. 	<p style="text-align: center;">FID</p> <ul style="list-style-type: none"> • Integrate PSYOP into all aspects of the foreign assistance programs, including internal development, humanitarian aid, and security assistance. • Develop campaigns to inform international community of U.S. intent and goodwill. <p style="text-align: center;">COUNTERINSURGENCY</p> <ul style="list-style-type: none"> • Assist the HN government in gaining the support of its people. • Assist the HN government in defeating the insurgents by shifting the loyalty of opposing forces and their supporters to friendly control. • Project a favorable U.S. image in the HN. • Develop products to influence neutral groups and the world community favorably. • Assist the HN in establishing defector rehabilitation programs. • Provide close and continuous PSYOP support to maximize the effect of civil-military operations. • Establish HN command support of positive population control and protection from insurgent activities. • Provide area assessment. <p style="text-align: center;">INSURGENCY</p> <ul style="list-style-type: none"> • Provide area assessment. • Create popular support for the resistance movement. • Develop passive support of the populace to allow insurgents to avoid detection and move freely. • Develop programs to gain converts and recruits for the resistance's political, military, and intelligence infrastructure. • Develop PSYOP products to popularize the anticipated reforms and programs to benefit the audience once the hostile government is overthrown. • Develop programs to inform world community of U.S. intent and goodwill. 	<ul style="list-style-type: none"> • Explain the purpose of the U.S. contingency action to counter disinformation. • Assist in establishing control of noncombatants, neutrals, and other groups in the area of operations to help minimize casualties and to prevent interference with friendly operations. • Prevent or deter interference by hostile forces or other nations in the contingency operation. • Provide continuing analyses of political and cultural factors to help maximize political and psychological effects of the operation. • Provide PSYOP support to noncombatant evacuation operations. • Minimize interference of indigenous populations. • Exploit withdrawal of U.S. forces while creating positive perceptions of U.S. intent and goodwill. 	<ul style="list-style-type: none"> • Counter the adverse effects of a terrorist act. • Inform the target audience of the terrorists' goals, leaders, and infrastructure. • Provide incentives to local populace to inform on terrorist groups. • Develop programs targeted at terrorist groups to persuade them that they cannot achieve their aims through terrorist activities, that they are at great personal risk, and that responsible governments will not negotiate with them under terrorist conditions. • Divide and undermine terrorists' support structure.

Figure B-1. PSYOP in support of low intensity conflict operations and in peace.

Strategic Level	Operational Level	Tactical Level
<ul style="list-style-type: none"> ● Project a favorable image of the United States. ● Support allies and other U.S. agencies in efforts to prevent war and assist in the resolution of a crisis without resorting to war. ● Assess opponent propaganda directed against U.S. targets, measure its effectiveness, and develop counterpropaganda. ● Prepare target population for introduction of U.S. forces into its country. ● Design PSYOP programs to explain U.S. policies to friendly and neutral audiences and to gain their acceptance of U.S. policies. ● Design PSYOP efforts to minimize friendly, neutral, or hostile civilian population interference with U.S. deployment operations. ● Convince the target the U.S. can fulfill its aspirations. ● Publicize and exploit opponent racial, ethnic, and religious prejudices and intolerances. ● Exploit opponent support of terrorist groups and activities. 	<p style="text-align: center;">DEEP OPERATIONS</p> <ul style="list-style-type: none"> ● Publicize and exploit harsh opponent population control measures and racial, ethnic, and religious practices. ● Encourage disaffection of opposing force civilian population. ● Build or create political and military alliance unity or disunity. ● Stimulate support of opposition elements within the opposing forces or government. ● Undermine confidence in opponent leadership and war aims. ● Create concern about the futility of war. ● Support resistance activities. ● Advertise program successes to friendly, neutral, and hostile audiences. ● Encourage disaffection of opposing troops. ● Provide support to deception operations. ● Support linkup with unconventional warfare element. <p style="text-align: center;">CLOSE OPERATIONS</p> <ul style="list-style-type: none"> ● Integrate PSYOP with battlefield maneuver plans. ● Provide area assessment; assess psychological effect of friendly operations. ● Explain U.S. policies to friendly and neutral audiences to gain their acceptance of U.S. policies or intended action. ● Conduct counterpropaganda programs. ● Capitalize on defeats. ● Encourage disaffection of troops. ● Conduct surrender appeals, synchronized with battle successes. ● Assist in battlefield control of displaced persons and refugees. ● Interrogate prisoners of war. ● Provide support to tactical deception operations. <p style="text-align: center;">REAR OPERATIONS</p> <ul style="list-style-type: none"> ● Assist MPPWCOM in prisoner-of-war camps. ● Develop HN contacts for language specialists and equipment usage. ● Conduct PSYOP to counter effects of hostile terrorist, sabotage, or special purpose force activities. ● Assist in control of displaced persons and refugees. ● Conduct counterpropaganda programs. ● Support civil-military operations. 	<ul style="list-style-type: none"> ● Create a favorable image of U.S. and allied soldiers' good treatment of EPWs. ● Discourage and disrupt opponent operations by spreading doubt, discontent, and distrust among opponent personnel in the targeted area. ● Support strategic PSYOP by furnishing detailed and timely information of local susceptibilities up the chain of command. ● Assist in tactical cover and deceptions operations. ● Induce surrender. ● Produce "Free Pass" leaflets and coordinate with friendly commands to ensure leaflets are honored. ● Design programs of psychological actions that are amplified by psychological products. <p style="text-align: center;">DEEP OPERATIONS</p> <ul style="list-style-type: none"> ● Assist in tactical cover and deception operations. ● Help control civilians in the combat area. ● Give information and directions to isolated friendly elements operating in the combat zone. ● Discourage and disrupt operations by spreading doubt, discontent, and distrust among opponent personnel. ● Lower enemy morale and efficiency by emphasizing friendly successes and the futility of dying. ● Emphasize danger to opponent of working in NBC environment. ● Provide "Free Pass" leaflets. ● Facilitate the occupation of opponent towns by delivering ultimatums and giving directions for ceasing hostilities. ● Publicize civilian control measures by using broadcasts and printed information. <p style="text-align: center;">REAR OPERATIONS</p> <ul style="list-style-type: none"> ● Provide area assessment to identify key leaders and local sensitivities. ● Create a favorable image of U.S. and allied soldiers and leaders to local populace. ● Counter hostile propaganda by initiating a well-planned, aggressive, and effective PSYOP program. ● Publicize civilian control measures by using broadcasts and printed information. ● Help control enemy and civilians in the combat area. ● Use local nationals and interpreters to establish effective communications nets and intelligence sources within rear area.

Figure B-2. PSYOP in conflict and war.

Appendix C

P S Y O P A p p r o v a l P r o c e s s

The approval by the appropriate authority of a planned PSYOP campaign is required before the execution of any psychological operations. The approval process during peacetime, hostilities short of war, and during war differ and will be explained in this appendix.

PEACETIME APPROVAL PROCESS

The regional CINC develops PSYOP campaign plans during peacetime and war to support national goals in his region. He forwards the campaign plan to the DOD staff for coordination with other government agencies and approval as detailed in DOD Directive S3321.1. This directive requires coordination of the peacetime PSYOP campaign with all pertinent government agencies and the approval of the NCA before execution. Upon approval, the peacetime PSYOP campaign plan is returned through channels to the respective CINC and country team(s).

(See Figure C-1.) Normally included with the approved plans are detailed implementing instructions. PSYOP staff officers ensure supporting PSYOP plans are consistent with the theater PSYOP plan and all activities are approved before execution. Peacetime approval requirements remain in effect in all peacetime operations as well as those conducted during crises and hostilities short of declared war. During the transition to hostilities, approval authority may be delegated to the unified CINC.

APPROVAL PROCESS DURING WAR

The unified command CINC has approval authority during war. This authority may be delegated down to a JTF. (See Figures C-2 and C-3.) However, recent combat experience has determined that once hostilities begin, the unified command CINC retains approval authority. It may be delegated (within the scope of the approved PSYOP campaign plan) to the senior PSYOP commander in the

theater. The sensitivity of PSYOP, combined with the need to coordinate all U.S. Government information efforts, dictates the retention of PSYOP campaign approval authority at the unified command CINC level. However, this does not preclude the delegation of approval authority "of PSYOP products to a JTF commander.

APPROVAL PROCESS DURING CONFLICT

The approval process during the transition from peace to war is complex. (See Figure C-4.) Approval of specific portions of products of the PSYOP campaign may be delegated to a JTF or POTG commander. The

approval and dissemination of all PSYOP in the theater, however, is coordinated with the unified command J3 and remains the responsibility of the CINC.

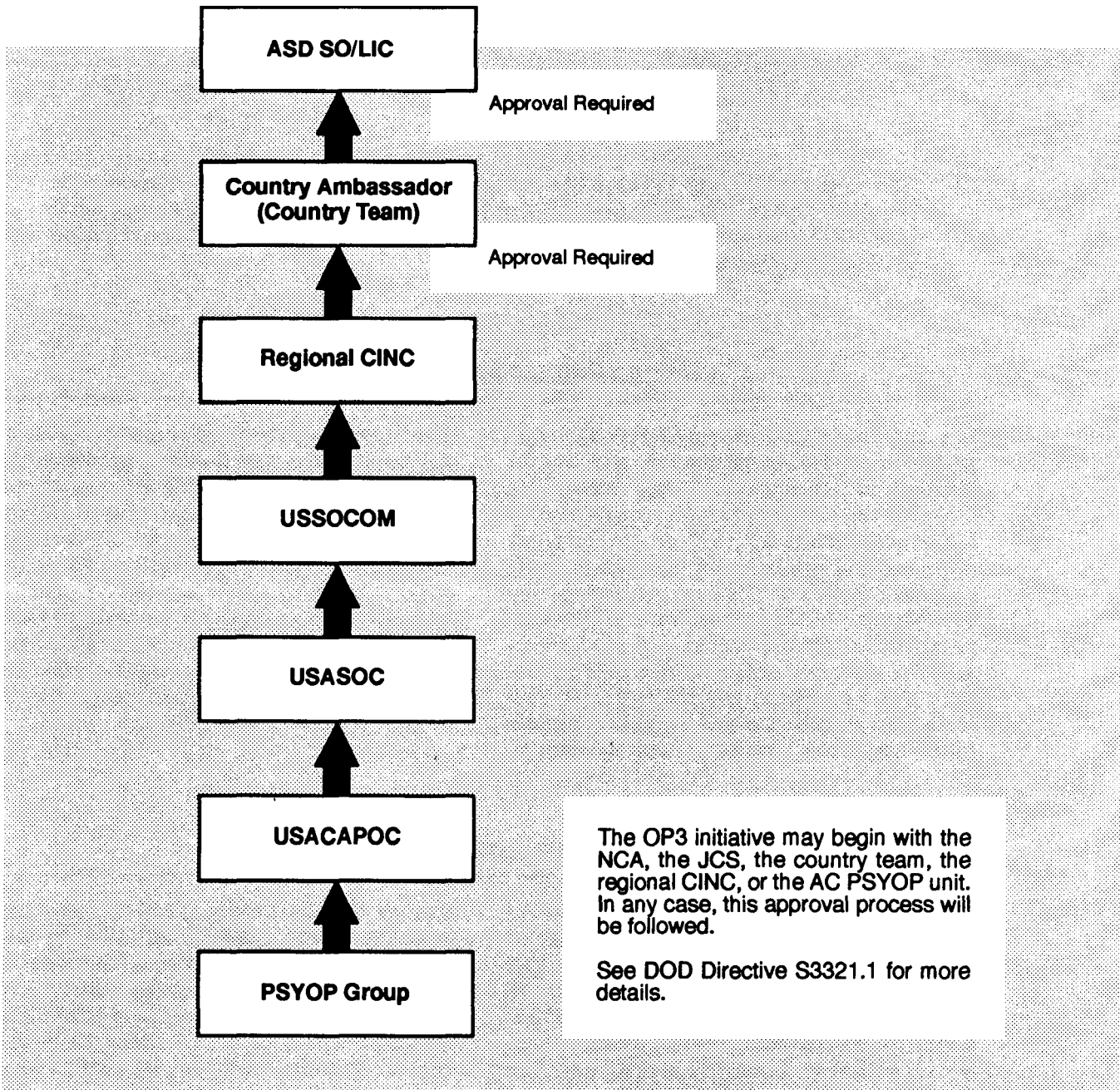

Figure C-1. Peacetime approval process (OP3).

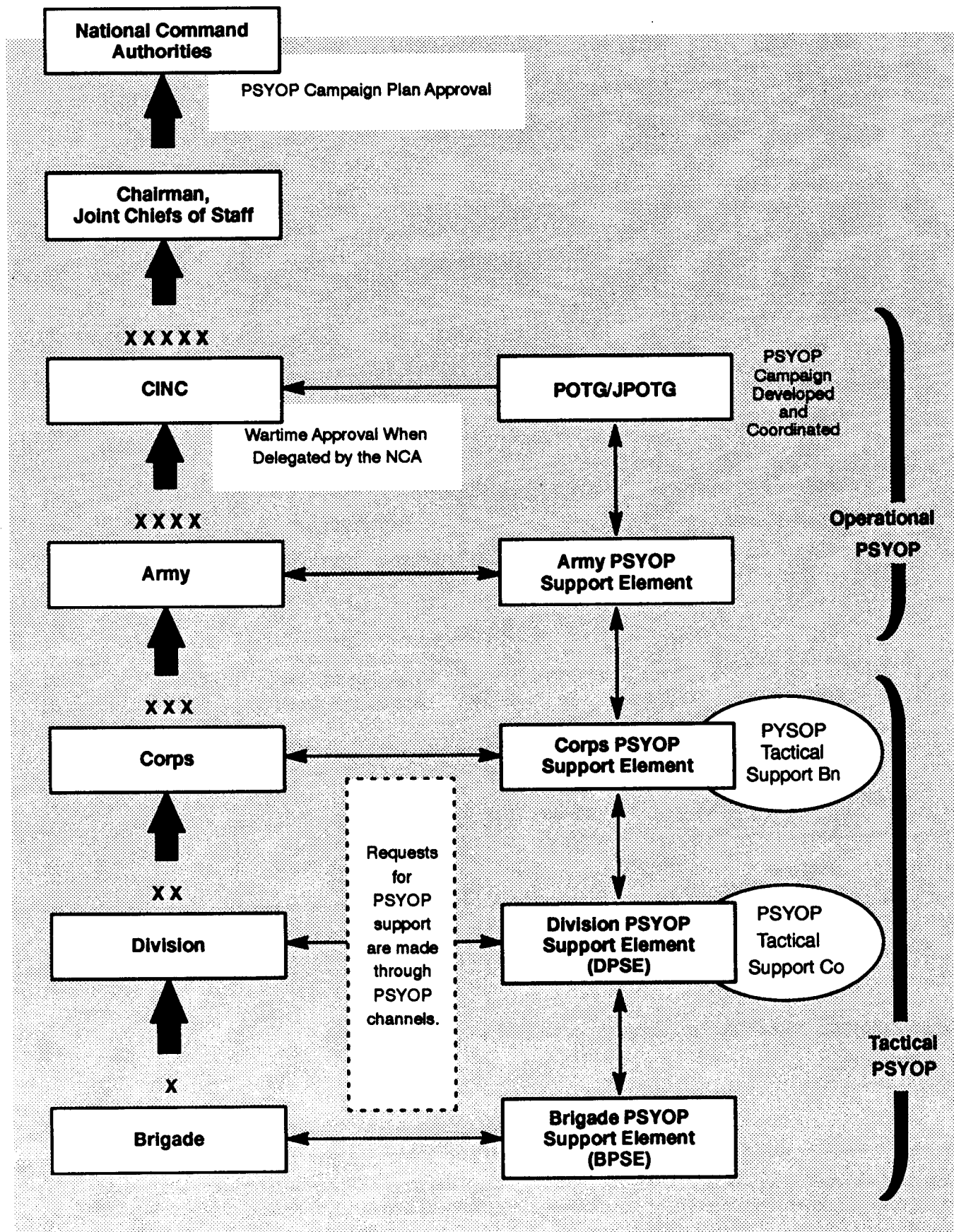

Figure C-2. Wartime PSYOP approval process with CINC in theater.

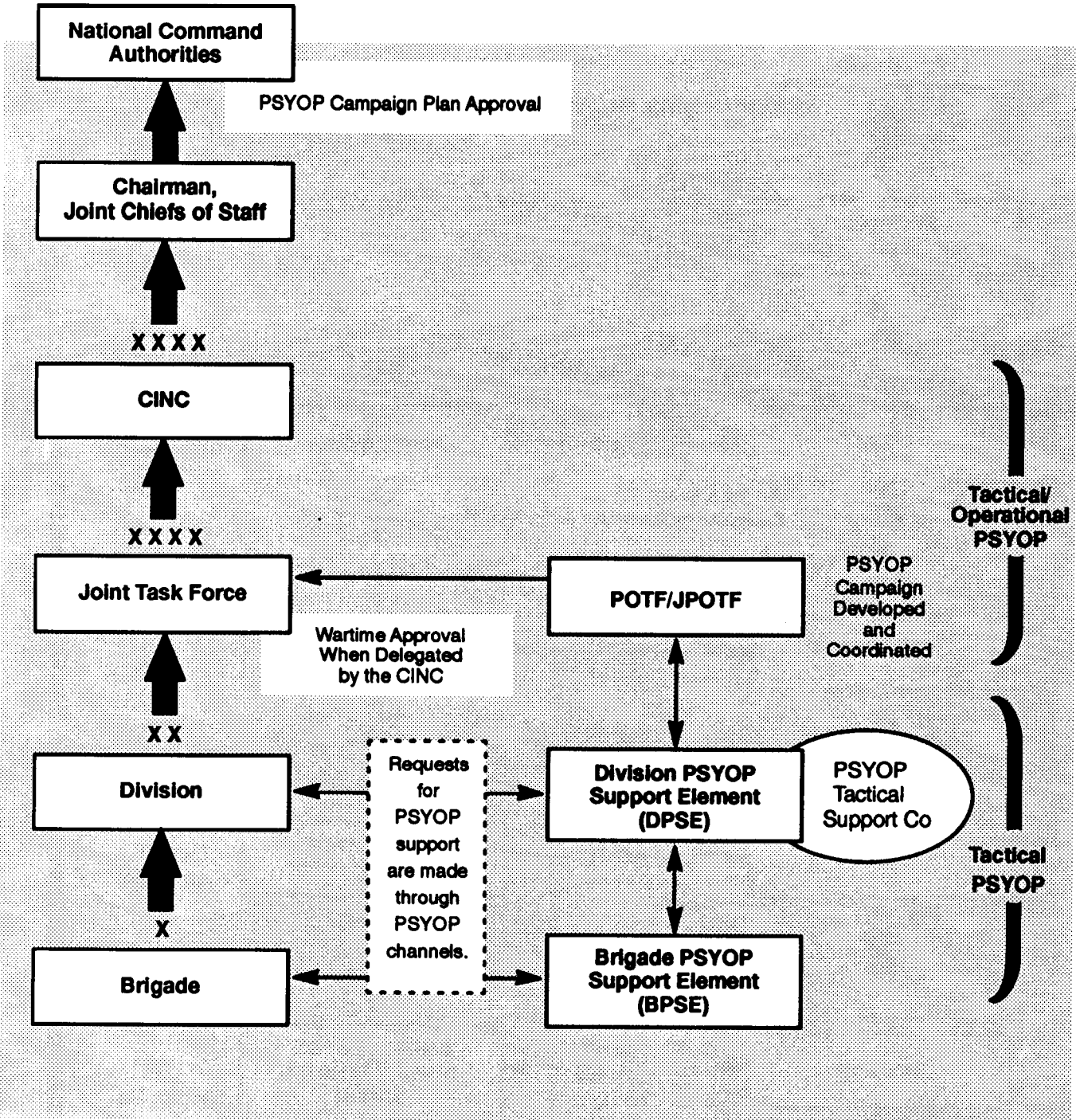

Figure C-3. Wartime PSYOP approval process without CINC in theater.

TACTICAL PSYOP SUPPORT

Tactical PSYOP support at corps, division, and brigade levels provides the maneuver commander with a robust tactical dissemination capability. As the approval authority for PSYOP is retained at EAC, it is envisioned

that the ground commander will receive operational and tactical PSYOP support (leaflet and broadcast operations) across his area of influence. The theater PSYOP plan includes this operational and tactical support and

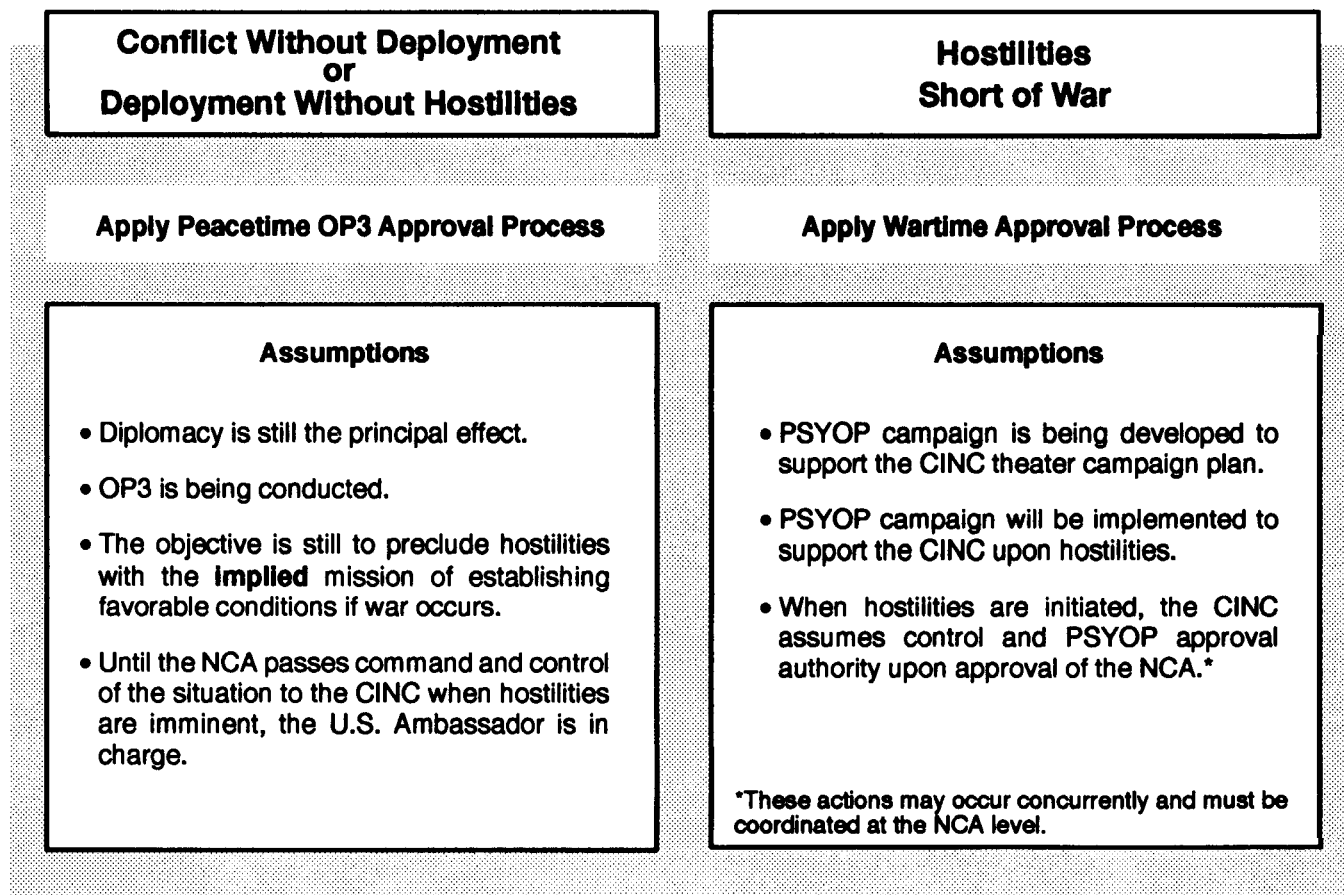

Figure C-4. PSYOP approval process during conflict.

remains highly visible and thoroughly integrated into the commander's tactical plan. PSYOP staff officers at all levels will be made fully aware of the theater PSYOP campaign plan so that the supported commander retains a full concept of the theater PSYOP effort. However, development and coordination of campaigns and the production of propaganda does not occur at the corps, division, or brigade levels. The PSYOP assets assigned to these levels provide a tactical dissemination capability across the commanders' front and have limited propaganda

development assets. These limited assets are designed to respond to suggested products from the maneuver commander. Upon receiving a tactical commander's request for a product, the tactical PSYOP unit's developmental cells develop a product within the commander's intent. They then forward the suggested product, through PSYOP technical channels, to the senior PSYOP headquarters in the theater for further development and approval. Upon approval, the product is produced and forwarded to the user level for dissemination.

LIAISON

Throughout this effort, the senior PSYOP headquarters establishes and maintains liaison with all supported component commanders and other government agencies in the theater. All component commanders, if not serving as a JTF commander, have the

same capability to request PSYOP products through their respective PSYOP liaison channels. Commanders at all levels may request mission-specific PSYOP support; however, the CINC or the JTF commander direct the priority of PSYOP support.

Appendix D

Operating Systems

This appendix explains how PSYOP commanders use function-oriented operating systems to integrate their activities. It begins with a broader combined arms perspective than the traditional focus on combat arms maneuver at the tactical level. This appendix then describes the Army's conventional operating systems. Finally, it shows how PSYOP commanders apply the BOS during mission planning and execution.

COMBINED ARMS

The combined arms concept stresses the combination of different arms and services to increase survival and combat effectiveness. The concept has existed for centuries, but its arrangement and the organizational level at which it occurs have varied. In World War I, the U.S. Army's square division stressed the tactics of supplementary or reinforcing combined arms. Artillery, engineers, and tanks increased the effectiveness of infantry in close combat. In World War II, the level of combined arms organization was the regimental combat team and armored combat command. The Army also

changed its tactics to emphasize complementary combined arms. The strengths of each arm offset the weaknesses of the others to create a synergistic effect.

Since World War II, the growing complexity of conventional warfare has led to increased specialization within the combat arms. Combined arms commanders now realize that all CS and CSS elements are equally important. They can no longer focus solely on their combat forces on the battlefield. To be successful in sustained combat operations today, they must synchronize the effects of their total force.

ARMY OPERATING SYSTEMS

To refine the combined arms concept, the Army adopted a blueprint of the battlefield for each level of war (TRADOC Pam 11 -9).

Each blueprint defines operating systems that integrate all combat, CS, and CSS activities by function (Figure D-1). This

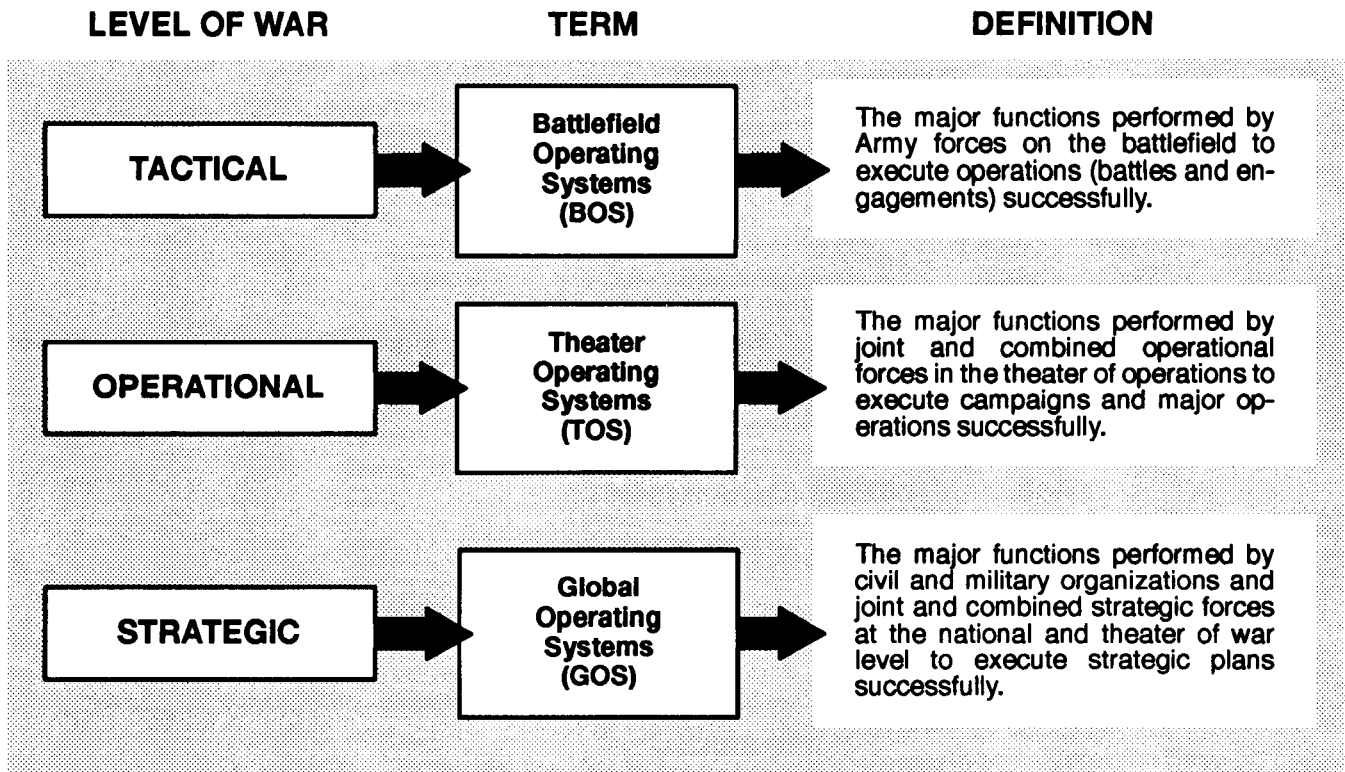

Figure D-1. Operating systems terminology.

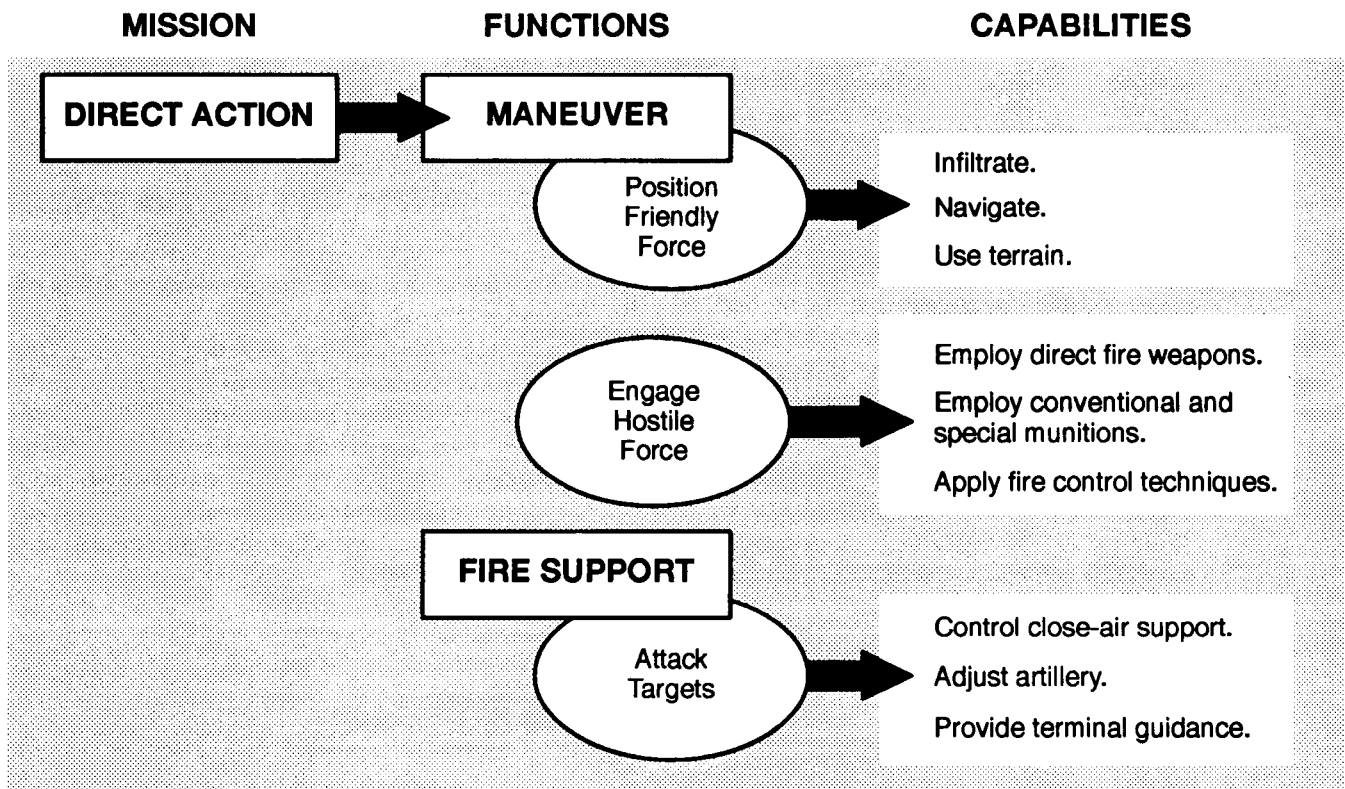

Figure D-2. Sample hierarchy functions.

methodology forces commanders and their staffs to think of integrated systems, rather than units in those systems.

Each operating system represents a hierarchy of functions (Figure D-2). Each function appears in only one operating system. Together, the operating systems provide a framework for analysis and integration.

The application of these blueprints and their operating systems depends on the purpose of the analysis or integration effort. Purposes of the blueprints include

- Mission area analysis to identify capabilities.
- Concepts and doctrine development to identify interdependencies and cut duplications.
- Force analysis and integration to identify mission-essential tasks and the capabilities of units to do them.
- Training development to provide a systematic combined arms perspective for developing and assessing unit training programs.
- Mission planning and execution to address and integrate the capabilities of the total force.

APPLICATION OF OPERATING SYSTEMS

The tactical-level BOS and the operational-level TOS appear in Figure D-3. The strategic-level GOS are under development.

Application of BOS

The BOS focus on Army units and their battlefield functions at corps level and below. The Army has integrated the BOS into its tactical doctrine. However, it has not yet included the TOS in its EAC doctrine. PSYOP commanders must therefore apply the BOS differently to portray PSYOP functions in terms useful to them. They must also provide linkages that help combat, doctrine, or training developers portray PSYOP functions in conventional Army terms.

NOTE: For ease of use, the BOS presented here appear in the same order as in an OPLAN or OPORD.

Intelligence

Intelligence is the collection, processing, and dissemination of information on the hostile force's capabilities, intentions, vulnerabilities, and the operational environment. Includes target acquisition.

PSYOP commanders rely heavily on theater and national intelligence systems. PSYOP often require near-real-time strategic intelligence for use at the tactical level. The commanders submit their PIR through channels to unify their requirements within the intelligence collection system. They thus exploit all available collection sources to satisfy PSYOP needs.

Maneuver

Maneuver is the employment of forces on the battlefield through movement, in combination with fire or fire potential, to achieve a position of advantage with respect to the hostile force. Includes engagement of the hostile force with direct fire or in close combat.

PSYOP elements maneuver primarily at the company level. These maneuvers always support the supported command or the PSYOP command's higher headquarters.

Fire Support

Fire support is the employment of target acquisition data, indirect-fire weapons, armed aircraft (less attack helicopters), and other lethal and nonlethal means against ground targets to support maneuver force operations. Includes artillery, mortars, naval

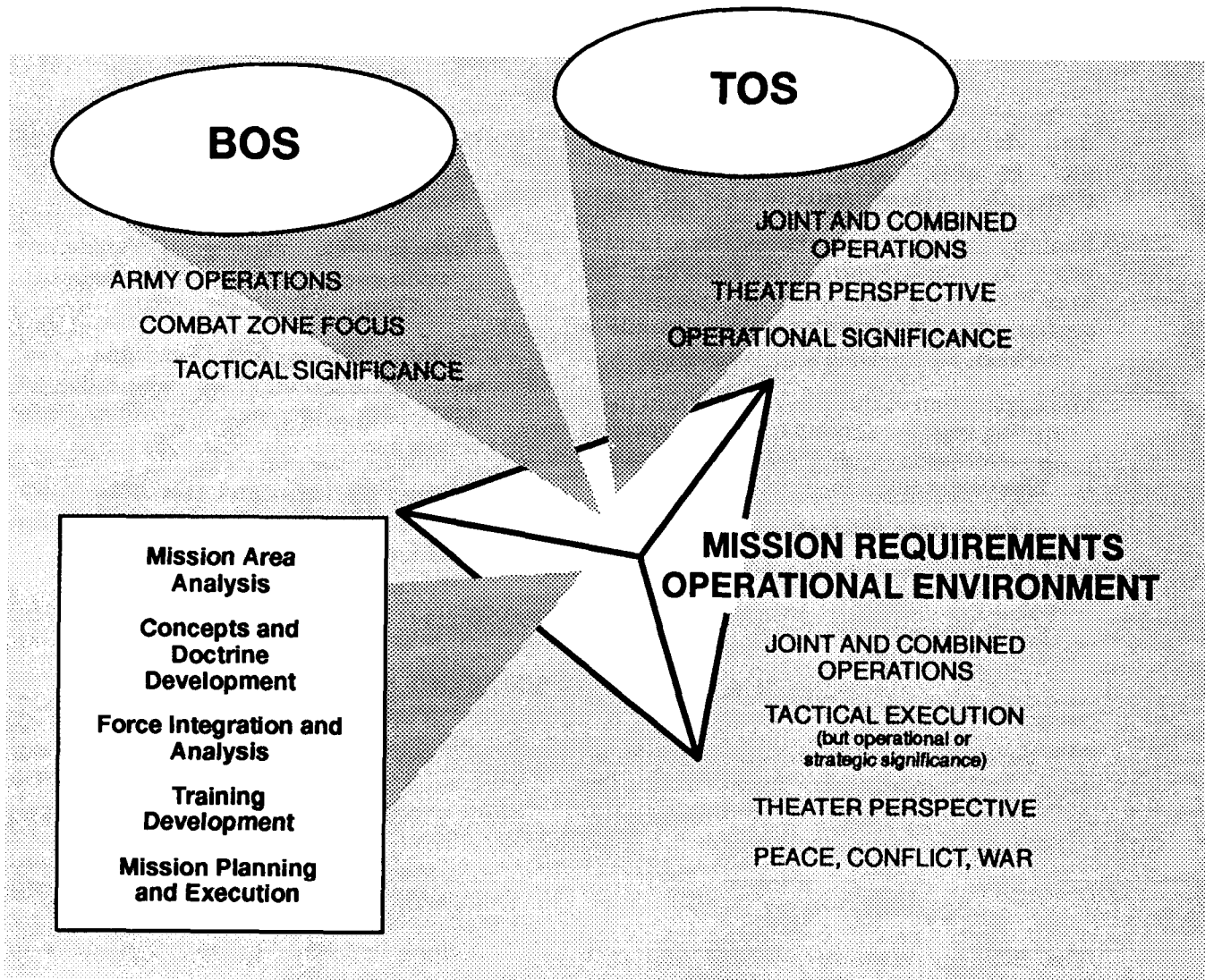

Figure D-3. Application of operating systems.

gunfire, close-air support, smoke, PSYOP, and electronic countermeasures. Does not include target acquisition.

BOS classify PSYOP as a nonlethal fire support means. PSYOP units do not have organic lethal fire support means except assigned small arms and M60 machine guns. During FID operations supporting SF missions and during missions supporting general purpose forces, fire support comes from various sources. Loudspeaker teams, for example, may receive fire support from field artillery, naval gunfire, or close air support aircraft.

Air Defense

Air defense is the employment of all lethal and nonlethal measures designed to nullify

or reduce the effectiveness of hostile air attacks.

PSYOP units do not have an organic air defense system. They use passive air defense measures to protect their elements. They rely on theater air defense systems to protect their base of operations.

Mobility and Survivability

Mobility and survivability is the enhancement of the friendly force's freedom of movement relative to the hostile force. It protects the friendly force from the effects of hostile weapons systems and natural occurrences. Includes countermobility, OPSEC, and deception.

PSYOP units rely on the same measures as general purpose units for their survivability. These measures include—

- Stationing the bulk of their C² and support elements deep within the COMMZ.
- Employing OPSEC and deception operations to conceal true capabilities and intentions.
- Maintaining standard defensive NBC capabilities.
- Providing physical security to operation sites.

Combat Service Support

Combat service support is the sustainment of the friendly force, primarily in the fields of logistics, personnel services, and health services. Includes CMO.

PSYOP group or battalion CSS capabilities are similar to unit-level capabilities in general purpose combat arms brigades. The PSYOP CSS system performs the same functions as conventional CSS systems and includes the following personnel:

- Planners and coordinators in the group and battalion S 1 and S4 sections.
- Operators in the group and battalion support companies.

The PSYOP commanders rely heavily on the TA CSS system. This system normally provides all DS-level CSS support to PSYOP units on an area basis by nondedicated CSS units. When area support is inappropriate or infeasible, the TA provides CSS on a unit basis by dedicated CSS units. TMs arrangement is most likely to occur in immature theaters or during contingency operations. PSYOP may also be useful in CMO to sustain the friendly force.

Command and Control

Command and control is the exercise of authority and direction by a commander over assigned forces in the accomplishment of the mission. Includes planning and communication functions.

The PSYOP C² system performs the same functions as conventional military C² systems. It may consist of—

- Joint PSYOP task group (JPOTG).
- Joint PSYOP task force (JPOTG).
- PSYOP task group (POTG).
- PSYOP task force (POTF).
- PSYOP group.
- PSYOP battalion.
- PSYOP C² elements collocated with supported conventional headquarter at all levels.
- Communications systems that connect all C² nodes.
- Combinations of one or more of the above.

Application of TOS

PSYOP must be a part of TOS' operational maneuver, operational intelligence, and operational support functions. During operational maneuvering, PSYOP can exploit tactical success into operational or strategic success. PSYOP assets need to use operational intelligence assets to develop PSYOP intelligence for use theaterwide or tactically. During operational support, PSYOP support CMO. The operational-level TOS are presented below.

Operational Intelligence

Operational intelligence is the collection, processing, and dissemination of information concerning operationally significant military and nonmilitary factors.

Operational Maneuver

Operational maneuver is the position of forces to create a decisive impact on the conduct of a campaign or major operation by either securing the operational advantages of position before battle occurs or exploiting tactical success to achieve operational or strategic success. Includes operational mobility to friendly operational formations.

Also includes operational countermobility to delay or otherwise hinder the movement of hostile operational formations.

Operational Fires

Operational fires are the attack of land, air (other than air defense), and sea targets to achieve an operationally significant objective. Operational fires are not fire support, and an operational maneuver does not necessarily depend on such fires.

Operational Protection

Operational protection is the protection of the friendly force from hostile operational maneuvers, hostile operational fires, and natural occurrences. Includes operational air defense, OPSEC, deception, and the safeguarding of operational formations.

Operational Support

Operational support is the sustainment of the friendly force in campaigns and major operations. Includes CMO.

Operational Command and Control

Operational command and control is the exercise of authority and direction by a properly designated commander over assigned operational forces in the accomplishment of the mission.

Application of GOS

Strategic-level GOS are under development. They will, however, most likely include PSYOP as a function because such operations support national objectives.

Appendix E

PSYOP Staff Officer Duties

A PSYOP staff officer normally serves as PSYOP coordinator. He follows the planning process outlined in JOPES, Volume I, Deliberate Planning Procedures, and Volume IV, Time-Sensitive Planning Procedures.

The PSYOP staff officer develops the PSYOP annex or appendix. He also includes PSYOP in the supported unit's OPLAN or OPORD. He develops either an annex or appendix depending on the unit level. For example, the PSYOP staff officer prepares a PSYOP appendix if the OPLAN has an operations annex. The PSYOP staff officer's four major duties are planning, coordinating, advising, and training. (See Figure E-1.)

Planning	Coordinating	Advising	Training
<p>Long-range PSYOP plans that support military missions within the theater.</p> <p>Crisis-action plans.</p> <p>Contingency plans.</p> <p>Exercise plans.</p>	<p>Obtains the CINC's approval for theater PSYOP policy.</p> <p>Supervises the staff in executing the CINC's directives, intentions, and orders.</p> <p>Coordinates operations to support UW, other PSYOP programs, SO commands, JTFs, and allied psychological operations.</p>	<p>Advises the commander, staff, and subordinate units on PSYOP activities and programs.</p> <p>Advises the PAO on effects of hostile PSYOP for troop and command information programs.</p> <p>Advises on command needs for trained PSYOP personnel, units, equipment, supplies, and research.</p> <p>Gives technical advice and aid in briefing defectors and EPWs.</p> <p>Gives input on new organization, equipment, techniques, requirements, and capabilities.</p>	<p>Prepares the PSYOP portion of training plans.</p> <p>Enhances the staff's understanding of PSYOP training throughout the command.</p> <p>Aids in foreign military PSYOP training.</p>

Figure E-1. PSYOP staff officer duties.

Appendix F

PSYOP in Support of Enemy Prisoner of War and Civilian Internee Operations

This appendix explains how psychological operations support the commander in the handling of EPW and civilian internee operations during a conventional war and in a low intensity conflict (LIC) environment.

SUPPORT OF EPW AND CIVILIAN INTERNEE PROGRAMS

Under U.S. national policy and international laws, the United States must care for and safeguard EPWS and civilian internees captured or taken by U.S. troops. Within the Army, the Military Police Prisoner of War Command (MPPWCOM) evacuates, processes, interns, controls, employs, and releases EPWS and civilian internees.

During a conflict, EPWS and civilian internees are continuous sources of current information accessible to the PSYOP community. If under U.S. control, PSYOP elements may use these individuals, with their consent, to pretest and posttest PSYOP product and action programs.

A PSYOP battalion (EPW/CI) OPCON to the MPPWCOM supports the PSYOP community. Tasks that support the overall PSYOP mission include—

- Collecting PSYOP information.
- Disseminating reports.
- Screening the EPW camp population.

- Interviewing and surveying the camp population.
- Recording EPW audio surrender appeals.

Collecting PSYOP Information

PSYOP personnel obtain information through interviews, interrogations, surveys, and material they get from EPWS and civilian internees. They process this data for use in ongoing PSYOP campaigns and forward it to the POTF or POTG for dissemination. The battalion quickly transmits perishable tactical PSYOP information collected at the EPW camps to the POTF or POTG for dissemination to tactical PSYOP units.

Disseminating Reports

The battalion distributes recurring reports to the theater POTF or POTG. These reports contain data on the numbers, nationalities, and ethnic composition of the EPW camp

population. These reports let the POTF or POTG determine if there are suitable target audiences in the EPW camp they can use to pretest and posttest PSYOP products and themes.

Screening the EPW Camp Population

The battalion screens the camp population for suitable interpreters and translators. Willing and capable EPWs and civilian internees can provide a variety of language skills to the PSYOP camp support team and the EPW camp staff. PSYOP personnel can also use defectors to help in the product development process.

Interviewing and Surveying the Camp Population

The battalion can interview and survey EPWs and civilian internees to assess the effectiveness of ongoing and previous PSYOP programs. PSYOP personnel try to determine how and to what extent their PSYOP messages will influence the enemy, influenced the EPW to surrender, and impacted on their morale or combat effectiveness. PSYOP personnel also try to learn the nature, extent, targets, and goals of the enemy's propaganda to raise his troops' morale and influence the civilian populace in the hostile theater. In addition, interviewers try to discover the goals and priority target audiences of the enemy's propaganda directed at U.S. and allied military units.

Recording EPW Audio Surrender Appeals

The EPW camp PSYOP support team uses cooperative EPWs to record surrender appeals. After recording raw material at the camp, the team sends the tapes to the POTF or POTG for final editing. The POTF or POTG then sends the tapes to DS PSYOP units for dissemination by radio, television, and/or tactical loudspeaker. The camp's PSYOP

support team can produce finished products with the MSQ-85B when the POTF or POTG tasks it to do so to capitalize on time-sensitive events.

Large EPW and civilian internee populations represent a militarily trained and potentially hostile populace located in the rear area. This populace is in the custody of a well-trained and armed MP force, thus reducing the threat it presents to U.S. combat operations. This MP force can be a strain on already scarce manpower resources. The PSYOP unit's mission is to help the MP force control and expose ENs to U.S. and allied policy. Such actions reduce the need to divert MP assets to maintain security in the EPW camp. Tasks that support the MP custodial mission in the camp include—

- Developing and executing PSYOP programs to condition EPWs and civilian internees to accept camp authority and regulations.
- Gaining the EPWs' and civilian internees' cooperation to reduce MP guard needs.
- Identifying malcontents, rabble rousers, trained agitators, and political officers within the camp who may try to organize a resistance or create disturbances within the camp.
- Developing and executing indoctrination programs to reduce or remove pro-enemy political activists (EPW and civilian internee).
- Helping the MP commander control the EPW and civilian internee population during emergencies.
- Planning and executing a PSYOP program that produces in the camp populace an understanding and appreciation of U.S. policies and actions. PSYOP personnel use comprehensive information, reorientation, educational, and vocational programs to prepare the EPWs for repatriation.
- Advising the MP camp commander on the psychological impact of actions to prevent misunderstandings and ensuing

disturbances by the EPWs. The difference in culture, custom, language, religious practices, and dietary habits can be so great that misunderstandings are not always avoidable. However, investigation and proper handling can minimize misunderstandings.

Additional PSYOP tasks include—

- Improving relations with the local population to reduce the camp's impact on the local populace and reduce any potential negative impact on camp operations.
- Developing and executing PSYOP programs against opponent partisan forces operating in the rear area.

PSYOP support of such activities must be coordinated with other PSYOP units having direct responsibility for that area. PSYOP units also coordinate with U.S. and allied rear forces operating within the area.

The supporting PSYOP unit commander informs the camp commander of ongoing PSYOP activities in the area that could possibly impact on his internment programs.

EPW camp PSYOP support team members have direct, unescorted access to the EPW compounds, enclosures, and individual EPWs or groups on a 24-hour basis. Face-to-face PSYOP are continuous to dispel potentially disruptive rumors and screen EPW complaints.

PSYOP personnel cannot coerce EPW contribution to PSYOP programs (preparing signed statements or making tape recordings). This rule is IAW the laws of land warfare derived from customs and treaties including the Geneva Conventions of 12 August 1949, paragraph 1, Article 3: the Hague Conven-

tions; and AR 190-8. FMs 19-40 and 27-10 contain further information about EPW rights and treatment.

Currently, there is only one PSYOP battalion (EPW/CI). It is an RC unit. This battalion supports EPW and civilian internee programs while working with MPs at corps-level holding areas. Corps-level holding areas provide the first semipermanent stopping point for EPWs after capture. The corps holding areas allow the battalion to support both tactical PSYOP within the corps AO and the overall EPW PSYOP mission. This battalion supports tactical operations by providing timely and immediate PSYOP-relevant information to the corps PSYOP officer. It provides information for dissemination to tactical loudspeaker teams. It also pretests tactical PSYOP products for use at the operational level. Additionally, EPWs coming into the corps holding areas provide immediate feedback on the effectiveness of current PSYOP programs. This feedback from the corps holding areas, which hold each EPW from 24 to 48 hours, is a highly valuable source for PSYOP-relevant intelligence.

Tactical PSYOP units coordinate with their supported commands G3 to learn the location of division EPW and civilian internee collection points and gather information from them through interviews, surveys, and collected materials. PSYOP personnel can then use this information in future programs. They can use this information to validate current programs. They coordinate with the division personnel operating the collection points before their establishment. PSYOP commanders do not allow PSYOP personnel within the collection point perimeter unless they have training in these operations.

EPW/CI PSYOP SUPPORT IN A LOW INTENSITY CONFLICT

The PSYOP support to EPW operations in a LIC environment does not change. Its importance increases in a counterinsurgency

operation. PSYOP personnel obtain information and define the target audiences for PSYOP campaigns. During operations in a

LIC environment, PSYOP support teams perform specific tasks during the phases of an insurgency.

Phase I

During this phase, PSYOP support teams—

- Pretest and posttest PSYOP products on captured insurgents and civilian internees to determine probable success rates in pacifying the HN target audience.
- Determine through interview or interrogation the demographic profile of the insurgents. As a minimum, PSYOP personnel obtain information on the following
 - Race.
 - Sex.
 - Political affiliation.
 - Religious affiliation.
 - Geographic origin.
 - Education levels.
 - Length/depth/type of involvement.
 - Previous or current occupation.
 - Standard of living/personal finances.
 - Previous military training.

- Determine and evaluate the effectiveness of the level of political and military indoctrination the insurgents have received to date.

Phase II

During this phase, PSYOP support teams—

- Continue pretesting and posttesting PSYOP products as previously stated.
- Continue defining and analyzing demographic profiles as previously stated.
- Cooperate with counterintelligence personnel to identify potential interned insurgents to be used as informants. These informants provide information on active insurgents within the HN's population and their field locations. In addition, these informants provide information about insurgent activities within the camp for control purposes.

Phase III

During this phase, PSYOP support teams continue to provide support as outlined in Phases I and II. The type and amount of support they provide will increase to levels normally found in support of conventional or regional contingency operations.

EPW/CI PSYOP SUPPORT DURING PEACETIME

EPW/CI battalion PSYOP support teams can assist peacetime counterdrug programs by pretesting and posttesting products to determine their effectiveness within the HN.

Additionally, they can provide demographic profile information to appropriate U.S. agencies as well as other PSYOP personnel.

Appendix G

The Joint Chiefs of Staff, Other Military Services, and PSYOP

This appendix briefly outlines the responsibilities of the JCS and the other military Services for PSYOP. This appendix is IAW current joint PSYOP doctrine.

JOINT CHIEFS OF STAFF

The Joint Chiefs of Staff—

- Advise the President and the Secretary of Defense of the use of military PSYOP that support national and strategic theater military goals in peacetime, hostilities short of war, or war.
- Establish joint doctrine for PSYOP.
- Issue Annex D (Psychological Operations) to JSCP.
- Advise the Secretary of Defense of Service and unified command PSYOP roles and missions.
- Guide the Service chiefs and the CINCs who plan and conduct military PSYOP that support national goals.
- Coordinate U.S. participation in allied military PSYOP training programs.
- Coordinate JCS' and CINC's PSYOP programs with the NCA, within DOD, and with proper civilian agencies, per national policy.
- Develop and maintain a long-range plan for strategic peacetime PSYOP that support national goals and military missions.
- Provide a consolidated, prioritized statement of military requirements for PSYOP capabilities to meet the needs of the NCA, CINCs, and Service chiefs. This statement of requirements guides the military departments in preparing their respective plans.
- Provide an integrated statement of requirements for PSYOP training.
- Maintain a joint automated data system to support PSYOP planning and analysis.

MILITARY DEPARTMENTS

The military department—

- Provide proper PSYOP training to civilian and military personnel.
- Provide Service forces the capabilities to execute PSYOP actions organic to them
- and, as appropriate, provide dedicated PSYOP forces, facilities, and equipment.
- Establish, sustain, and fund programs to build departmental and joint PSYOP capabilities.

- Provide PSYOP forces or detachments for service in foreign countries IAW missions and forces' organization.
- Provide intelligence and trained analysts equipped and organized to support and conduct PSYOP planning.
- Execute strategic PSYOP campaigns or actions, when directed, IAW missions and forces' organization.

Army

The Army—

- Acts as the JCS executive agent IAW EO-501-84 for joint PSYOP training.
- Develops PSYOP doctrine, tactics, techniques, and procedures for its primary functions.
- Coordinates, as appropriate, with the other Semites.

Navy

The Navy coordinates, as appropriate, with the other Services.

Air Force

The Air Force—

- Develops PSYOP doctrine, tactics, techniques, and procedures for its primary functions.
- Coordinates, as appropriate, with the other Semites.

Marine Corps

The Marine Corps coordinates, as appropriate, with the other Services.

Note: The Marine Corps has limited PSYOP capabilities.

COMMANDERS OF UNIFIED COMMANDS

The unified command commanders—

- Establish liaison with regional authorities to coordinate PSYOP, particularly in peacetime.
- Plan, support, and conduct overt PSYOP in coordination with the NCA and the chiefs of U.S. diplomatic missions. In peacetime and during hostilities short of war, overt PSYOP support U.S. regional objectives, policies, interests, and theater military missions.

- Prepare PSYOP programs and conduct PSYOP that support theaterwide operations during war.
- Foster cooperative PSYOP policies among allied military forces and security organizations.
- Ensure advance contingency planning for the use of non-DOD informational and related capabilities in DOD PSYOP.

JOINT TASK FORCE

A joint task force—

- Coordinates all its PSYOP efforts with proper U.S. and coalition force authorities.
- Incorporates PSYOP in its operational plans.
- Maintains current PSYOP estimates for designated AO.

- Monitors and reviews components' PSYOP plans and coordinates the development of proper PSYOP forces capabilities.
- Establishes and monitors a PSYOP reporting system.

CIVIL AFFAIRS COORDINATING RELATIONSHIP

A primary CA function is to provide the military commander information on the civilians' status in the country where military operations are ongoing or being planned. This information includes everything from health status of animals to religious taboos. FM 41-10 covers in detail all responsibilities for CA operations.

PSYOP can provide key support and information for CMO. When effectively integrated, PSYOP are the commander's primary communications source with the civilian population.

CA performs two major support actions for the commander. It—

- Reports on the status of the civilians in the country where military operations are occurring or being planned.

- Advises the civil government on the economy when military action ends.

PSYOP can provide CA a broad range of assistance during CMO. The important elements of this support are—

- Informing civilians on the proper procedures to take to ensure their safety.
- Preparing civilians for the period after the military conflict is over when CA will be involved in restoring public order.

PSYOP can strongly influence civilians' attitude toward American policy and personnel designated to carry it out. What we say, backed by our actions, can be decisive in securing the safety of civilians and restoring the government and the economy. These actions will lessen the military commander's burden and are a force multiplier.

PUBLIC AFFAIRS

Current Army public affairs (PA) responsibilities include but are not limited to—

- Keeping AC and RC soldiers, family members, DOD and DA civilian employees, and retirees informed about Army issues and developments. Command information is the process used to inform internal audiences. PA uses command information to increase efficiency, heighten morale, and promote organizational cohesiveness.
- Providing information to American and foreign publics. These external programs are known as public information and community relations.
- Evaluating public opinion about the Army.

The field manual for Public Affairs Operations (Draft) states—

"Public Affairs personnel and resources are not used in psychological operations. Psychological operation products are neither published in nor transmitted by, PA means. PA participation in psychological warfare is counter to the Congressional intent mentioned earlier in this section and damages the credibility of PA personnel with the news media. Civil Affairs and PSYOP personnel do work closely together. PSYOP units have fled and printing capabilities, which may be used by PA personnel to have materials reproduced."

CA' civil-military audience, PA' foreign public, and PSYOP' target audience may at times be the same audience, CA, PA and PSYOP personnel must coordinate to ensure none of

their activities contradict each other and to ensure they support the commander's goals. Issues involving coordinating relationships between PSYOP, CA, and PA are being addressed at decision levels beyond the scope of this FM. The PSYOP operator must know

about these issues. Also, PSYOP relationships with perception management, public diplomacy, and political warfare have been and continue to be discussed, again outside the scope of this publication.

G l o s s a r y

Section I. ACRONYMS AND ABBREVIATIONS

AC Active Component	ARSOA Army special operations aviation
ACB Allied Command Europe	ARSOC Army special operations command
AFCENT Allied Forces, Central Europe	ARSOF Army special operations forces
AFNORTH Allied Forces, Northern Europe	BOS battlefield operating systems
AFSOUTH Allied Forces, southern Europe	BPA battlefield psychological activities
ARTEP Army Training and Evaluation Program	BPS basic PSYOP study
ASD (SO/LIC) Assistant Secretary of Defense for Special Operations and Low Intensity Conflict	C² command and control
ASG area support group	C⁴I command, control, communications, computers, and intelligence
ASIC all-source intelligence center	CA civil affairs
ASP ammunition supply point	CAP crisis action procedures
AO area of operations	CD counterdrug
AOR area of responsibility	CFE conventional Armed Forces in Europe
AR Army regulation	CI counterintelligence

CIA
Central Intelligence Agency

CINC
commander in chief

CJCS
Chairman, Joint Chiefs of Staff

cmd
command

CMO
civil-military operations

CNOD
counternarcotics operations division

COA
course of action

COCOM
combatant command

COIN
counterinsurgency

COMMZ
communications zone

COMSEC
communications security

CONPLAN
concept plan

CONUS
continental United States

COSCOM
corps support command

CS
combat support

CSR
controlled supply rate

CSS
combat service support

CT
counterterrorism

DA
direct action

DCS
defense communications system

DCSLOG
Deputy Chief of Staff for Logistics

DCSOPS
Deputy Chief of Staff for Operations and Plans

DIA
Defense Intelligence Agency

DISCOM
division support command

DOD
Department of Defense

DOJ
Department of Justice

D O S
Department of State

DOT
Department of Transportation

DPA
Director of Personnel and Administration

DPG
Defense Planning Guidance

DPO
Director of Plans and Operations

DS
direct support

DSU
direct support unit

EAC
echelons above corps

FNS
foreign nation support

HHC
headquarters and headquarters company

HN
host nation

HQ
headquarters

HSC
headquarters and support company

I&W	indications and warning	JPOTF	joint psychological operations task force
IAW	in accordance with	JPOTG	joint psychological operations task group
ICC	information coordinating committee	JSCP	Joint Strategic Capabilities Plan
IEW	intelligence and electronic warfare	JSOA	joint special operations area
IMINT	imagery intelligence	JSOTF	joint special operations task force
IPA	intelligence production agency	JSPS	Joint Strategic Planning System
IPB	intelligence preparation of the battlefield	JTB	joint target board
		JTF	joint task force
J2	intelligence officer	LAN	local area network
J3	joint operations officer	LIC	low intensity conflict
J3/C3	joint/combined operations officer	LOC	lines of communication
J31	deputy joint operations officer	MACOM	major Army command
J33	current operations officer	MEF	Marine Expeditionary Force
J5	joint plans officer	METT-T	mission, enemy, terrain, troops, and time available
J5/C5	Joint/combined plans officer	MFP II	Major Force Program 11
JCS	Joint Chiefs of Staff	mgt	management
JFC	joint force commander	MMC	Materiel Management Center
JIC	joint intelligence center	MOI	memorandum of instruction
JOA	joint operations area	MOU	memorandum of understanding
JOD	Joint Operations Division	MP	military police
JOPES	Joint Operations Planning and Execution System		

MPPWCOM
Military Police Prisoner of War Command

MTP
mission tasking package

MTT
mobile training team

NATO
North Atlantic Treaty Organization

NBC
nuclear, biological, and chemical

NBCC
NBC center

NCA
National Command Authorities

NEO
noncombatant evacuation operations

NMCS
National Military Command System

NMSD
National Military Strategy Document

NSC
National Security Council

OAE
operational area evaluation

OCONUS
outside the continental United States

OIR
other information requirements

OP3
overt psychological peacetime program

OPCON
operational control

OPLAN
operation plan

OPORD
operation order

OPREP
operational report

OPSEC
operations security

ORF
operational readiness float

OSD
Office of the Secretary of Defense

PA
public affairs

PAO
public affairs officer

PAP
PSYOP awareness program

PCB
psychological operations and
civil affairs branch

PCO
peacetime contingency operations

PDC
product development center

pers
personnel

PERSCOM
personnel command

PIR
priority intelligence requirements

PLL
prescribed load list

POADS
PSYOP Automated Data System

POD
port of debarkation

POE
port of embarkation

POLAD
political advisor

POTF
psychological operations task force

POTG
psychological operations task group

PPBS
planning, programming, and
budgeting system

PPFD
plans, programs, and force development

PSC personnel services company	SAC stand-alone capability
PSS personnel service support	SAR search and rescue
PSYOP psychological operations	SECDEF Secretary of Defense
PSYREP psychological operations report	SF Special Forces
pub publication	SJA staff judge advocate
PWRMS pre-positioned war reserve materiel stocks	SME subject matter expert
PX Army exchange	SO special operations
RAC research and analysis company	SOC special operations command
RC Reserve Component	SOCRATES Special Operations Command Research, Analysis, and Threat Evaluation System
RMO resource management officer	SOD special operations division
ROE rules of engagement	SOF special operations forces
RSB regional support battalion	SOP standing operating procedure
RSC regional support company	SOR statement of operational requirements
RSG regional support group	SPA special PSYOP assessment
RSR required supply rate	SPS special PSYOP study
S1 adjutant	SR special reconnaissance
S2 intelligence officer	STANAG standardization agreement
S3 operations and training officer	STOD special technical operations division
S4 supply officer	TA theater Army
SA security assistance	TAACOM theater Army area command

TACON
tactical control

TACSAT
tactical satellite

TAMCA
theater Army movement control agency

TAMMC
theater Army materiel management center

TASOSC
theater Army special operations
Support command

TCS
theater communications system

TCSB
third country support base

TOS
theater operating systems

TRADOC
United States Army Training and
Doctrine Command

TRANSCOM
transportation command

TSB
tactical support battalion

TSC
tactical support company

TSG
tactical support group

TV
television

U.S.
United States

UBL
unit basic load

UIC
unit identification code

UN
United Nations

USACAPOC
United States Army Civil Affairs and
Psychological Operations Command

USAID
United States Agency for International
Development

USAJPESWCS
US. Army John F. Kennedy Special
Warfare Center and School

USASOC
United States Army Special Operations
Command

USCENTCOM
United States Central Command

USCINCSOC
Commander in Chief, United States Special
Operations Command

USEUCOM
United States European Command

USIA
United States Information Agency

USIS
United States Information Service

USLANTCOM
United States Atlantic Command

USPACOM
United States Pacific Command

USSOCOM
United States Special Operations
Command

USSOUTHCOM
United States Southern Command

USSPACECOM
United States Space Command

USTMSCOM
United States Transportation Command

UW
unconventional warfare

VCJCS
vice chairman of the Joint Chiefs of Staff

WRMS
war reserve materiel

WWMCCS
Worldwide Military Command and Control
System

Section II. DEFINITIONS

- accessibility** - The availability of an audience for targeting by psychological operations.
- agents of action** - Persons and organizations who carry out or conduct programs of psychological actions.
- Discretionary** - Persons and organizations whose activities are planned primarily for their psychological impact.
- Incidental** - Persons and organizations whose activities generate a psychological impact secondary to the military operation.
- antiterrorism** - Defensive measures used to reduce the vulnerability of individuals and property to terrorism. (Joint Pub 1-02) (See also combatting terrorism, counterterrorism.)
- battlefield psychological activities** - (DOD, NATO) Planned psychological activities conducted as an integral part of combat operations and designed to bring psychological pressure to bear on enemy forces and civilians under enemy control in the battle area, to assist in the achievement of the tactical objectives. (Joint Pub 1-02)
- broadcast footprints** - The area covered by electronic transmission: that is, radio transmission.
- capability** - (DOD) The ability to execute a specified course of action. (Capability may or may not be accompanied by an intention.) (Joint Pub 1-02)
- chemical warfare** - (DOD) All aspects of military operations involving the employment of lethal and incapacitating munitions/agents and the warning and protective measures associated with such offensive operations. Since riot control agents and herbicides are not considered to be chemical warfare agents, those two items will be referred to separately or under the broader term "chemical," which will be used to include all types of chemical munitions/agents collectively. The term "chemical warfare weapons" may be used when it is desired to reflect both lethal and incapacitating munitions/agents of either chemical or biological origin. (Joint Pub 1-02)
- civil affairs** - (DOD) Those phases of the activities of a commander which embrace the relationship between the military forces and civil authorities and people in a friendly country or area or occupied country or area when military forces are present. Civil affairs include matters concerning the relationship between military forces located in a country or area and the civil authorities and people of that country or area usually involving performance by the military forces of certain functions or the exercise of certain authority normally the responsibility of the local government. This relationship may occur prior to, during, or subsequent to military action in time of hostilities or other emergency and is normally covered by a treaty or other agreement, expressed or implied. (Joint Pub 1-02)
- civil-military operation** - The complex of activities in support of military operations embracing the interaction between the military force and civilian authorities fostering the development of favorable emotions, attitudes, and behavior in neutral, friendly, or hostile groups. (FM 41-10)
- collateral special operations activities** - The inherent capabilities of all military forces may periodically be applied to accomplish missions other than those for which the forces are principally organized, trained, and equipped. Collateral activities in which special operations forces, by virtue of inherent capabilities, may be tasked to participate include humanitarian assistance, security assistance, search and rescue, counterdrugs, antiterrorism and other security activities, and special activities. (Joint Pub 3-05)
- combatant command (COCOM)** - Non-transferable command authority established by Title 10, United States Code, Section 164, which flows from the NCA and is exercised only by commanders of unified and specified combatant commands. Combatant command is the authority of a combatant commander to perform those

functions of command over assigned forces involving organizing and employing commands and forces, assigning tasks, designating objectives, and giving authoritative direction over all aspects of military operations, joint training, and logistics necessary to accomplish the missions assigned to the command. Combatant command should be exercised through the commanders of subordinate organizations; normally this authority is exercised through the Service component commander. Combatant command provides full authority to organize and employ commands and forces as the commander in chief considers necessary to accomplish assigned missions. (Joint Pub 3-0)

combatant commander - A commander in chief of one of the unified or specified combat commands established by the National Command Authorities. (Joint Pub 3-0)

combatting terrorism - (DOD) Actions, including antiterrorism (defensive measures taken to reduce vulnerability to terrorist acts) and counterterrorism (offensive measures taken to prevent, deter, and respond to terrorism) taken to oppose terrorism throughout the entire threat spectrum. (Joint Pub 1-02)

competitor - A nation, agency, or organization that seeks the same resource, market, or advantage sought by the United States.

conditions - Those external elements that affect a target audience but over which they have little or no control. Conditions may be man-made or environmental in nature.

consolidation - (DOD) The combining or merging of elements to perform a common or related function. (Joint Pub 1-02)

consolidation PSYOP - Psychological operations conducted in foreign areas inhabited by an enemy or potentially hostile populace and occupied by U.S. forces or in which U.S. forces are based, to result ultimately in behaviors by the foreign populace that support U.S. objectives in the area.

counterinsurgency - (DOD) Those military, paramilitary, political, economic, psycho-

logical, and civic actions taken by government to defeat insurgency. (Joint Pub 1-02)

counterpropaganda - Programs of products and actions designed to nullify propaganda or mitigate its effects.

counterterrorism - Offensive measures to prevent, deter, and respond to terrorism, including intelligence gathering and threat analysis in support of those measures. (Joint Pub 3-05)

country team - Senior members of U.S. Government agencies assigned to a U.S. diplomatic mission overseas and subject to the direction or supervision of the Chief, U.S. Mission (ambassador). Normally, such members meet regularly (weekly) to coordinate U.S. Government political, economic, and military activities and policies in the host country. (*See also* U.S. country team.)

deception - Those measures designed to mislead the enemy by manipulation, distortion, or falsification of evidence to induce him to react in a manner prejudicial to his interests. (Joint Pub 1-02)

direct action - (DOD) In special operations, a specified act involving operations of an overt, clandestine, or low visibility nature conducted primarily by a sponsoring power's special operations forces in hostile or denied areas. (Joint Pub 1-02)

direct action (DA) mission - Short-duration strikes and other small-scale offensive actions principally taken by special operations forces to seize, destroy, or inflict damage on a specified target; or to destroy, capture, or recover designated personnel or material. In the conduct of these operations, special operations forces may employ raid, ambush, or direct assault tactics; emplace mines and other munitions; conduct standoff attacks by fire from air, ground, or maritime platforms; provide terminal guidance for precision guided munitions; and conduct independent sabotage. (Joint Pub 3-05)

executive order - Order issued by the President by virtue of the authority vested in him by the Constitution or by an act of Congress. It has the force of law. (AR 3 10-25)

foreign internal defense - (DOD) Participation by civilian and military agencies of

a government in any of the action programs taken by another government to free and protect its society from subversion, lawlessness, and insurgency. (Joint Pub 1-02)

foreign nation support - Civil resources identification, negotiation, and procurement from available resources within a foreign nation in support of the U.S. military mission during wartime, preparation for war, or peacetime.

host nation - A nation in which representatives or organizations of another state are present because of government invitation or international agreement. The term particularly refers to a nation receiving assistance relevant to its national security.

information -

1. (DOD) In intelligence usage, unevaluated material of every description that may be used in the production of intelligence.

2. (NATO) In intelligence usage, unprocessed data of every description which may be used in the production of intelligence. (Joint Pub 1-02)

insurgency - (DOD, NATO) An organized movement aimed at the overthrow of a constituted government through use of subversion and armed conflict. (Joint Pub 1-02)

Joint Chiefs of Staff - Staff within the Department of Defense, which consists of the Chairman, who is the presiding officer thereof but who has no vote; the Chief of Staff, United States Army; the Chief of Naval Operations; and the Chief of Staff, United States Air Force. The Joint Chiefs of Staff are the principal military advisors to the President, the National Security Council, and the Secretary of Defense. (AR 310-25)

joint doctrine - (DOD) Fundamental principles that guide the employment of forces of two or more Services in coordinated action toward a common objective. It will be promulgated by the Joint Chiefs of Staff. (Joint Pub 1-02)

joint force commander (JFC) - The commander of forces from two or more military

departments. The JFC includes subordinate unified commanders, joint task force commanders, functional component commanders, and commanders of specific operational forces. (Joint Pub 3-0)

joint operations - operations carried on by two or more of the Armed Forces of the United States (Army, Navy, Air Force). (AR 310-25)

joint special operation area (JSOA) - A restricted area of land, sea, and air-space assigned by a theater commander to the commander of joint special operations forces to conduct special operations activities. The SOC or JSOTF commander assigns specific JSOAs (or sectors of a single JSOA) to a subordinate SOF commander for mission execution. The scope and duration of the SOF mission, friendly and hostile situation, and politico-military considerations all influence the number, composition, and sequencing of SOF elements deployed into a JSOA. It may be limited in size to accommodate a discrete direct action mission or may be extensive enough to allow a continuing broad range of unconventional warfare operations. (Joint Pub 3-05)

key communicator - An individual to whom the target audience turns most often for an analysis or interpretation of information or events.

low intensity conflict - (DOD) Political-military confrontation between contending states or groups below conventional war and above the routine, peaceful competition among states. It frequently involves protracted struggles of competing principles and ideologies. Low intensity conflict ranges from subversion to the use of armed force. It is waged by a combination of means employing political, economic, informational, and military instruments. Low intensity conflicts are often localized, generally in the Third World, but contain regional and global security implementations. Also called LIC. (Joint Pub 1-02)

media - Transmitters of information and psychological products.

National Command Authorities - (DOD) The president and the Secretary of Defense or their duly deputized alternates or successors. Commonly referred to as NCA. (Joint Pub 1-02)

national objectives - (DOD) Those fundamental aims, goals, or purposes of a nation—as opposed to the means for seeking these ends—toward which a policy is directed and efforts and resources of the nation are applied. (Joint Pub 1-02)

national policy - (DOD) A broad course of action or statements of guidance adopted by the government at the national level in pursuit of national objectives. (Joint Pub 1-02)

national security - (DOD) A collective term encompassing both national defense and foreign relations of the United States. Specifically, the condition provided by—

- A military or defense advantage over any foreign nation or group of nations.
- A favorable foreign relations position.
- A defense posture capable of successfully resisting hostile or destructive action from within or without, overt or covert. (Joint Pub 1-02)

national strategy - (DOD) The art and science of developing and using the political, economic, and psychological powers of a nation, together with its armed forces, during peace and war, to secure national objectives. (Joint Pub 1-02)

nonbelligerent third party - A nation, agency, or organization present in an area of operations (or with representatives present) that may function as an intermediate audience.

opponent - An antagonistic force or organization that counters mission accomplishment by military means.

power - The ability or capacity to perform effectively or target audience effectiveness.

product - Any visual, audio, or audiovisual item generated and disseminated in support of a PSYOP program.

product development center (PDC) - That organization within the operations element of a PSYOP battalion or company in which programs of products or actions are developed.

propaganda -

1. (DOD) Any form of communication in support of national objectives designed to influence the opinions, emotions, attitudes, or behavior of any group in order to benefit the sponsor, either directly or indirectly.

2. (NATO) Any information, ideas, doctrines, or special appeals disseminated to influence the opinion, emotions, attitudes, or behavior of any specified group in order to benefit the sponsor either directly or indirectly.

psychological actions - Activities conducted for their psychological impact.

psychological operations -

1. (DOD) Planned operations to convey selected information and indicators to foreign audiences to influence their emotions, motives, objective reasoning, and ultimately the behavior of foreign government, organizations, groups, and individuals. The purpose of psychological operations is to induce or reinforce foreign attitudes and behavior favorable to the originator's objectives. Also called PSYOP.

2. (NATO) Planned psychological activities in peace and war directed to enemy, friendly, and neutral audiences in order to influence attitudes and behavior affecting the achievement of political and military objectives. They include strategic psychological activities, psychological consolidation activities, and battlefield psychological activities.

psychological warfare - The planned use of propaganda and other psychological actions having the primary purpose of influencing the opinions, emotions, attitudes, and behavior of hostile foreign groups in such a way as to support the achievement of national objectives. (Joint Pub 1-02)

PSYOP campaign - A series of PSYOP programs conducted at the theater level to achieve short- and mid-term objectives in support of a CINC'S goals.

PSYOP objective - A statement of a measurable response that reflects the desired attitude or behavior change of a selected foreign target audience as a result of psychological operations.

P8YOP program - A sequential, coordinated presentation of a series of actions and/or products to achieve a specific PSYOP objective.

action program - A sequential, coordinated presentation of a series of actions to achieve a specific PSYOP objective.

product program - A sequential, coordinated presentation of a series of products to achieve a specific PSYOP objective.

refugee - (DOD) A civilian who by reason of real or imagined danger has left home to seek safety elsewhere. (Joint Pub 1-02)

security assistance - (DOD) Group of programs authorized by the Foreign Assistance Act of 1961, as amended, and the Arms Export Control Act of 1976, as amended, or other related statutes by which the United States provides defense articles, military training, and other defense-related services, by grant, loan, credit, or cash sales in furtherance of national policies and objectives. (Joint Pub 1-02)

special air operation - Any operation conducted in support of special operations activities. (Joint Pub 3-05)

special operations -

1. (DOD) Operations conducted by specially trained, equipped, and organized DOD forces against strategic or tactical targets in pursuit of national military, political, economic, or psychological objectives. These operations may be conducted during periods of peace or hostilities. They may support conventional operations, or they may be prosecuted independently when the use of conventional forces is either inappropriate or infeasible. [Joint Pub 1-02)

2. Actions conducted by specially organized, trained and equipped military and para-military forces to achieve military,

political, economic, or psychological objectives by nonconventional military means in hostile, denied, or politically sensitive areas. They are conducted in peace, conflict, and war, independently or in coordination with operations of conventional forces. Politico-military considerations frequently shape special operations, requiring clandestine, covert, or low visibility techniques, and oversight at the national level. Special operations differ from conventional operations in degree of physical and political risk operational techniques, mode of employment, independence from friendly support, and dependence on detailed operational intelligence and indigenous assets. (Joint Pub 3-05)

special reconnaissance (SR) operations -

Reconnaissance and surveillance actions conducted by special operations forces to obtain or verify, by visual observation or other collection methods, information concerning the capabilities, intentions, and activities of an actual or potential enemy, or to secure data concerning the meteorological, hydrographic, geographic, or demographic characteristics of a particular area. It includes target acquisition, area assessment, and post-strike reconnaissance. (Joint Pub 3-05)

strategic psychological activities - (DOD,

NATO) Planned psychological activities in peace and war which normally pursue objectives to gain the support and cooperation of friendly and neutral countries and to reduce the will and the capacity of hostile or potentially hostile countries to wage War. [Joint Pub 1 -02)

susceptibility - The sensitivity of the target audience to psychological appeals based on their vulnerabilities.

symbol - A visual or aural means used to convey a theme.

target audience - An individual or group selected for influence or attack by means of psychological operations.

target audience analysis - The process by which potential target audiences are identified and analyzed for effectiveness, accessibility, and susceptibility.

terrorism - (DOD)

1. The unlawful use or threatened use of force or violence against individuals or property to coerce or intimidate governments or societies, often to achieve political, religious, or ideological objectives. *See also* antiterrorism, counterterrorism. (Joint Pub 1-02)

2. The calculated use of violence or the threat of violence to attain goals, political, religious, or ideological in nature. This is done through intimidation, coercion, or fear. Terrorism involves a criminal act often symbolic in nature and intended to influence an audience beyond the immediate victims. (AR 190-52)

theme - A theme is a subject, topic, or line of persuasion used to achieve a psychological objective.

time-phased force and deployment data -

The computer-supported data base portion of an operation plan; it contains time-phased force data, non-unit-related cargo and personnel data, and movement data for the operation plan, including

- In-place units.
- Units to be deployed to support the operation plan with a priority indicating the desired sequence for their arrival at the port of debarkation.
- Routing of forces to be deployed.
- Movement data associated with deploying forces.

- Estimates of non-unit-related cargo and personnel movements to be conducted concurrently with the deployment of forces.
- Estimate of transportation requirements that must be fulfilled by common-user lift resources as well as those requirements that can be fulfilled by assigned or attached transportation resources.

unconventional warfare - A broad spectrum of military and paramilitary operations conducted in enemy-held, enemy-controlled, or politically sensitive territory. Unconventional warfare includes, but is not limited to, the interrelated fields of guerilla warfare, evasion and escape, subversion, sabotage, and other operations of a low visibility, covert, or clandestine nature. These interrelated aspects of unconventional warfare may be prosecuted singly or collectively by predominantly indigenous personnel, usually supported and directed in varying degrees by (an) external source(s) during all conditions of war or peace. (Joint Pub 1-02)

U.S. country team - The senior, in-country, U.S. coordinating and supervising body, headed by the chief of the U.S. diplomatic mission, usually an ambassador, and composed of the senior member of each represented U.S. department or agency. (See also country team).

vulnerability - Manifestation of an unsatisfied or perceived need in an individual or a target audience.

References

SOURCES USED

These are the sources quoted or paraphrased in this publication.

EXECUTIVE ORDER

12333 US Intelligence Activities

DEPARTMENT OF DEFENSE (DOD) DIRECTIVES

S3321.1	Overt Peacetime Psychological Operations Conducted by the Military Services in Peacetime and in Contingencies Short of Declared War <i>26 July 1984</i>	5105-38-M	Security Assistance Management Manual <i>October 1988</i>
5100.77	Law of War Program <i>10 July 1979</i>	5240.1	Activities of DOD Intelligence Components That Affect US Persons

JOINT PUBLICATIONS (Joint Pubs)

0-2	Unified Action Armed Forces (UNAAF) <i>1 December 1986</i>	3-53	Joint Psychological Operations Doctrine <i>1 February 1987</i>
1-02	Department of Defense Dictionary of Military and Associated Terms <i>1 December 1989</i>	5.0	Doctrine for Planning Joint Operations <i>July 1991 (Test)</i>
Test 3-0	Doctrine for Joint Operations <i>1 January 1990</i>	5-02.1	Joint Operation Planning System, Vol I (Deliberate Planning Procedures) (w/C1) <i>September 1989</i>
3-05	Joint Special Operations <i>1 January 1986</i>		
Test 3-07	Doctrine for Joint Operations in Low-Intensity Conflict <i>October 1990</i>	5-02.4	Joint Operations Planning System, Vol IV <i>8 May 1989</i>

ARMY REGULATIONS (ARs)

12-1	Security Assistance-Policy, Objectives, and Responsibilities <i>7 October 1988</i>	310-25	Dictionary of United States Army Terms <i>21 May 1986</i>
12-15	Joint Security Assistance Training (JSAT) Regulation <i>28 February 1990</i>	381-10	US Army Intelligence Activities <i>1 July 1984</i>
190-52	Countering Terrorism and Other Major Disruptions on Military Installations <i>15 July 1983</i>		

FIELD MANUALS (FMs)

12-50	US Army Bands <i>6 September 1991</i>	90-2	Battlefield Deception <i>3 October 1968</i>
27-1	Judge Advocate Legal Service <i>15 September 1989</i>	100-5	Operations <i>5 May 1986</i>
31-20	Doctrine for Special Forces Operations <i>20 April 1990</i>	100-10	Combat Service Support <i>18 February 1988</i>
34-1	Intelligence and Electronic Warfare Operations <i>2 July 1987</i>	100-20	Low Intensity Conflict <i>5 December 1990</i>
34-3	Intelligence Analysis <i>15 March 1990</i>	100-25	Doctrine for Army Special Operations Forces (SF, Rangers PSYOP, ARSOA) <i>12 December 1991</i>
34-36	Special Operations Forces Intelligence and Electronic Warfare Operations <i>June 1991</i>	101-5	Staff Organization and Operations <i>25 May 1984</i>

ARMY TRAINING AND EVALUATION PROGRAM (ARTEP)

33-705-MTP Mission Training Plan for a Psychological Operations Battalion Headquarters
23 October 1989

PUBLIC LAWS

1973 War Powers Resolution	10 USC 176
Title V, 1980 Amendment to National Security Act	International Law and Military Policy
Arms Export Control Act of 1986	Hague Conventions
Foreign Assistance Act of 1983	Geneva Conventions 1880 and 1949
	Treaty Law in NATO

Index

- action programs 1-12
 approval process
 during conflict C-2
 during war C-1
 peacetime C-1
 Army operating systems D-1
 attacks and raids 3-30
 audio surrender appeals F-2
 battalion headquarters and
 support company 4-10
 battlefield operating systems 1-10
 air defense D-4
 combat service support 9-1, D-5
 command and control 5-1, D-5
 intelligence D-3
 fire support D-3
 maneuver D-3
 mobility and survivability D-4
 blueprint of the battlefield 1-9, D-1
 BOS (See battlefield operating systems)
 broadcast company 4-7
 C² (See command and control)
 CA (See civil affairs)
 campaign plan tenets 7-3
 campaign planning 7-2, A-2
 capabilities 1-1
 casualty reporting 9-8
 civil affairs G-3
 climate and weather analysis 8-5
 CMO D-5
 COCOM 1-6
 collateral activities 3-19
 humanitarian assistance 3-19
 counterdrug 3-19
 security assistance 3-19
 combatant command 5-4, 5-6
 combating terrorism 3-25, B-1
 combat service support 9-1
 and PSYOP 9-3
 in a mature theater 9-4
 in an immature theater 9-8
 command and control 5-1, D-5
 communications 5-17
 COMMZ 9-7, D-5
 conflict environment 2-2
 conflict 1-8
 conflicts short of war 1-8
 consolidation PSYOP 1-8, 3-5

contingency operations	3-3, 3-30, B-2	EPW and civilian internee	F-1
attacks and raids	3-30	face-to-face communications	
demonstrations	3-30	1-3, 3-6, 4-13
disaster relief	3-30	FID (See foreign internal defense)	
freedom of navigation	3-31	field services	9-6
military support to counterdrug		finance operations	9-8
operations	3-31	FNS (See foreign nation support)	
noncombatant evacuation	3-30	foreign internal defense	3-12, 3-17, B-2
protection of shipping	3-31	foreign nation support	9-4
recovery	3-30	force structure	4-1
restoration of order	3-31	full mobilization	5-18
security assistance	3-31	Geneva Conventions	1-5, F-4
show-of-force	3-30	geographic analysis	8-6
conventional operations	3-20	global CINCs	5-6
coordinating authority	5-8	global operating systems	1-9
COSCOM	9-7	graves registration	9-3
counterdrug	3-19, 3-31	group headquarters and	
counterintelligence	8-2	headquarters company	4-1
counterterrorism	3-10, 3-18	HA (See humanitarian assistance)	
CSS (See combat service support)		Hague Conventions, The	1-5, F-3
CT (See counterterrorism)		humanitarian assistance	3-10, 3-19
DA (See direct action)		IEW support to PSYOP	8-3
data base integration	8-6	JCS (See Joint Chiefs of Staff)	
deception operations	1-3, 3-3	joint and combined operations	3-2
Defense Planning Guidance	1-4	Joint Chiefs of Staff	5-2, G-1
defensive operations	3-23	joint operations planning and	
deliberate mission planning	7-12	execution process	7-6
deliberate planning process	7-6	joint SO targeting process	7-9
demographic evaluation	8-5	joint strategic planning process	7-2
demonstrations	3-30	joint task force	3-2, 4-1, 5-6, G-2
deployment	5-17	JOPEs (See joint operations planning	
direct action	3-18	and execution process)	
disaster relief	3-30	JPOTF	D-5
dissemination battalion	4-5	JPOTG	4-1, D-5
dissemination company (RC)	4-13	JSCP	1-6, G-1
DOD Directive 3321.1	1-6	JTF (See joint task force)	
electronic warfare	8-2	key communicators	1-3
employment	6-1	laws of war	1-3
EPW camp support team	F-2	legal aspects of PSYOP	1-5

liaison	5-20, C-5	operations	
LIC (See low intensity conflict)		close	B-3
limitations	1-1	combatting terrorism	B-2
low intensity conflict	3-24, F-3	contingency	3-3
maintenance	9-7	conventional	3-20
mission planning	7-1	counterinsurgency	B-3
mission	3-1, 4-1, 7-1	joint and combined	3-2
mobilization levels	5-18	deception	3-3
MPPWCOM	F-1	deep	B-3
National Command Authorities		defensive	3-23
.....	1-6, 1-18, G-1	FID	B-3
National Security Council	1-4	insurgency	B-2
national security policy	1-4, 7-2	offensive	3-22
national security, organization for	5-2	peacekeeping	B-2
NATO	1-5	rear	B-3
NBC	1-4, D-5	unified	5-9
NCA (See National Command Authorities)		OPSEC	3-23, 7-14, D-5
noncombatant evacuation operations		partial mobilization	5-18
.....	3-30	peacekeeping	3-27
OAE (See operational area evaluation)		operations	B-2
offensive operations	3-22	training	3-28
OP3	1-6	peacetime approval process	C-1
OPCON (See operational control)		peacetime	1-8
operating systems	D-1	PERSCOM (See personnel command)	
operational area evaluation	8-6	personnel services company	9-7, 9-8
operational command and control	D-6	personnel command	9-8
operational continuum	1-7, 3-31, B-1	personnel service support	9-7
conflict	1-8	personnel services	9-7
peacetime	1-8	planning	
war	1-8	considerations	7-4
operational control	1-6, 4-1, 5-7	process	
operational environment	3-11	deliberate	7-6, 7-12
operational fires	D-6	time-sensitive	7-6, 7-13
operational intelligence	8-2, D-5	post-mission activities	7-16
operational level	B-3	postal operations	9-8
operational maneuver	D-5	POTG	6-1, D-5
operational protection	D-6	PPBS	5-6
operational support	D-6	PPFD officer	4-4
		principles of war, application of	1-9
		print company	4-5
		product and action programs	1-12

product programs	1-12	Air Force	G-2
PSC (See personnel services company)		JCS	G-1
PSYOP		JTF	G-2
analysis process	8-4	Marine Corps	G-2
approval process	C-1	Navy	G-2
battalion (enemy prisoner of war/civilian internee) (RC)	4-20	Unified Commands	G-2
battalion	D-5	signal company	4-8, 6-2
broadcast company	4-7, 6-2	staff officer	E-1, J-1
capabilities	1-1, 1-3, A-2	studies	3-2, 3-29
CSS and	9-3	support of	
dissemination battalion headquarters	4-5	SOF collateral activities	3-19
dissemination battalion	4-5, 6-1	SOF operations	3-10
dissemination company (RC)	4-13	tactical support battalion headquarters and support company	4-12
enemy prisoner of war/civilian internee support company	4-22	tactical support battalion	4-11, 6-2
EPW company	6-2	tactical support company	4-12, 6-2
estimates	3-2	tactical support group (RC)	4-18
force structure	4-1	theater	5-15
group headquarters and headquarters company	4-1	threats to	2-1
group	D-5	public affairs	G-3
IEW support to	8-3	public laws	1-8
legal aspects of	1-7	reconstitution	9-10
limitations	1-1, 1-3	regeneration	9-10
mission	3-1, 4-1, 7-1	regional CINCs	5-4
print company	4-5, 6-1	regional support battalion headquarters and support company (AC and RC)	4-8
programs	1-12, 3-2	regional support company	4-11
action	1-12	regional support group	4-13
coordinating and directing	3-2	relationships among combatant commands	5-8
developing, producing, and disseminating	3-2	reorganization	9-10
product and action	1-12	replacement operations	9-8
product	1-12	research and analysis company (RC) ...	4-17
role and responsibilities	1-2	resupply	9-11
regional support battalion headquarters and support company (AC and RC)	4-8, 6-2	SAR (See search and rescue)	
regional support company	4-11, 6-2	search and rescue	3-10
regional support group	4-13	security assistance	3-19, 3-31
research and analysis company (RC)	4-17	selective mobilization	5-17
responsibilities of		show-of-force operations	3-30
Army	G-2	signal company	4-8
		social and political environment	2-3

SOCRATES	8-6	theater PSYOP	5-15
SO		theater strategy	7-2
activities	3-10	threats to PSYOP	2-1
imperatives	3-11	conflict environment	2-2, 3-11
principles	3-11	social and political environment	2-3
special reconnaissance	3-10, 3-18	technical environment	2-2
special staff group	4-2	time-sensitive planning process	7-6
SR (See special reconnaissance)		time-sensitive planning	7-13
strategic intelligence	8-2	TOS	D-3
strategic level	B-3	total mobilization	5-18
strength management	9-7	transportation	9-7
TACON (See tactical control)		Treaty Law in NATO	1-5
tactical control	5-7	unconventional warfare	3-10, 3-13
tactical intelligence	8-4	unified combatant command	5-4
tactical level	B-3	unified commands	G-2
tactical PSYOP support	C-4	unified operations	5-9
tactical support battalion	4-10	United States Army Civil Affairs and Psychological Operations Command (See USACAPOC)	
tactical support company	4-12	United States Army Special Operations Command (See USASOC)	
tactical support group (RC)	4-18	United States Special Operations Command (See USSOCOM)	
TAMCA	9-7	USACAPOC	5-13, 8-4
target audience analysis	8-5	USASOC	5-11, 8-4
target audience	1-3, 2-2, 4-2	USSOCOM	5-9, 8-4
targeting	7-1	UW (See unconventional warfare)	
TASOSC	5-13	war reserve materiel stocks	9-4
technological environment	2-2	war	1-8
theater army	5-13		
theater operating systems	1-9		
theater organization	5-9		

By Order of the Secretary of the Army:

Official:

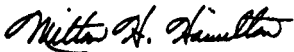
MILTON H. HAMILTON
*Administrative Assistant to the
Secretary of the Army*
03316

GORDON R. SULLIVAN
*General, United States Army
Chief of Staff*

By Order of the Marine Corps:

RONALD D. ELLIOTT
Executive Director
Systems Command
U.S. Marine Corps

DISTRIBUTION:

ACTIVE ARMY, USAR, AND ARNG: To be distributed in accordance with DA Form 12-11-E, requirements for FM 33-1, Psychological Operations, (Qty rqr block no. 1116).